

Closure Using LinMot Linear Rotary Motors

Torque closure
Angle closure
Snap-on closure

LinMot[®]

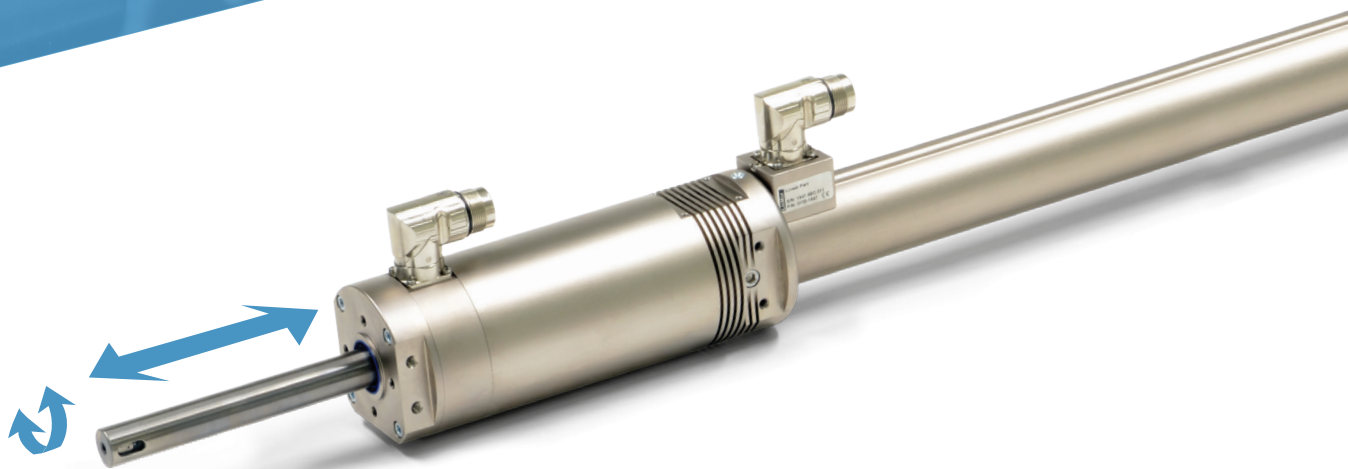

Bottles



Jars

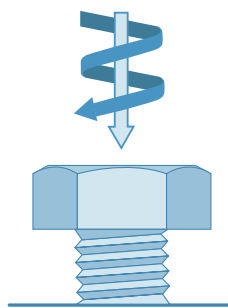

Screws

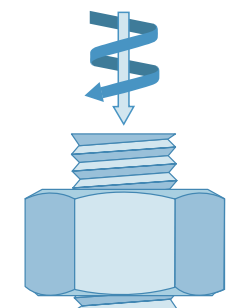

Nuts

FLEXIBLE AND REPRODUCIBLE CLOSURE AND SCREWDRIVING PROCESSES

LinMot linear rotary motors have been developed for closure and screwdriving processes, allowing flexible closure and screwdriving processes to be implemented easily.

- One physical axis with independently programmable linear and rotary motions
- Readout of torque, rotary speed, angle, vertical position, linear speed, and force
- Open parameterization of positions, linear speed, rotary speed, force, torque
- Can be integrated in any control system

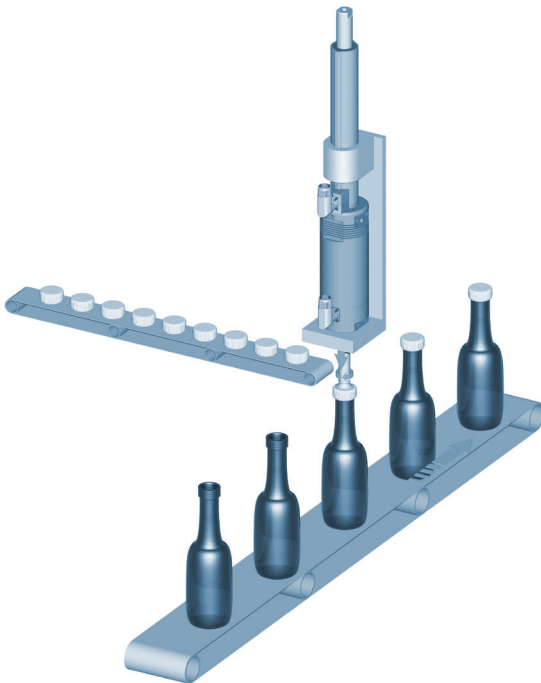

STATIONARY CLOSURE SYSTEM

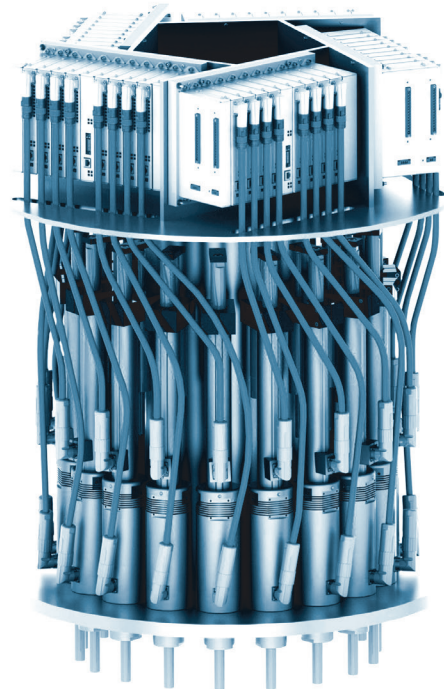

CAROUSEL CLOSURE SYSTEM

1

PICK UP CAP

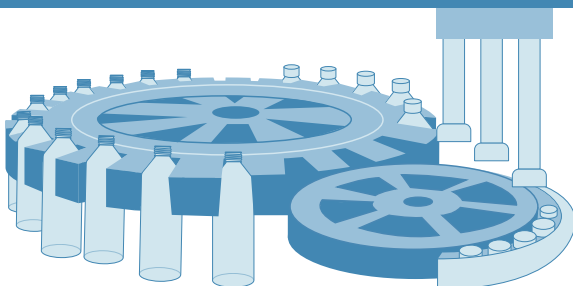

- The linear motor allows highly dynamic picking of the cap, and also has the ability to detect jammed caps in the fixture automatically by means of the following error.

2a

POSITION CAP STANDARD

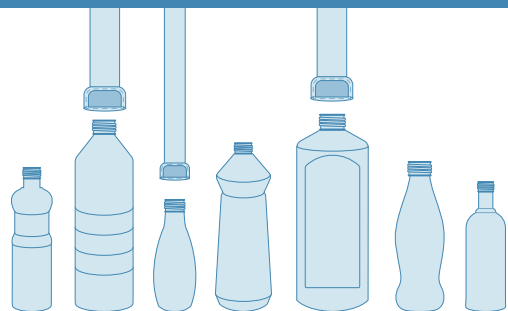

- The programmable linear axis can be used to pre-position the cap at any desired position. This makes it possible to change over automatically when changing products on the line.

2b

POSITION CAP AEROSOLS

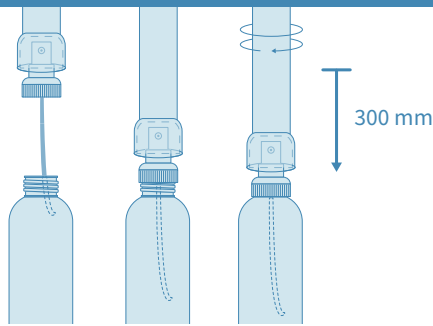

- The long stroke of up to 300 mm means that containers for pump sprays or aerosols with long intake tubes in the cap can be closed without any trouble.

2c

POSITION CAP PHARMA

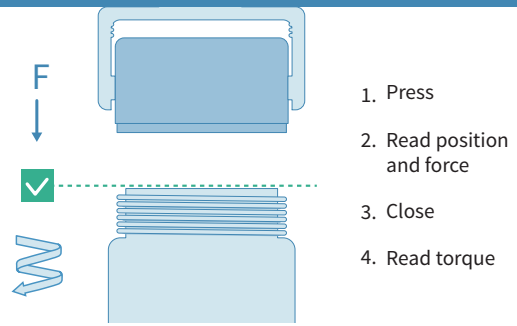

- The complex sequences for safety caps on medications can be programmed individually. Current information, such as the actual position, forces, and torques can be captured.

3a

CLOSURE STANDARD

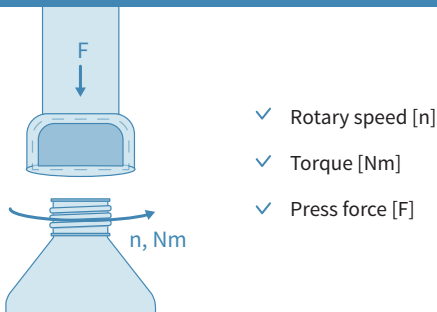

- The rotary speed, torque, and vertical press force can be defined freely for the closure operation. For complex tasks, these parameters can also be modified continuously during the closure process

3b

SNAP-ON WITH CAP ALIGNMENT

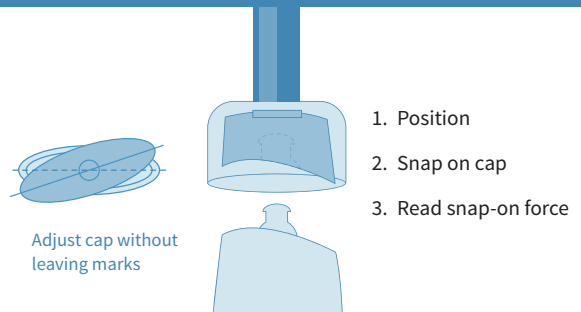

- The linear-rotary unit can be positioned precisely to pick up the cap. This means no pre-positioning is needed. The cap is snapped onto the top of the bottle smoothly, even at high cycle times and high forces.

4

CHECK TORQUE

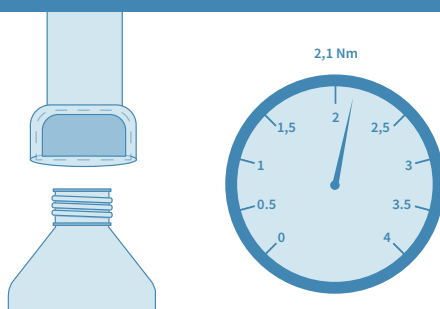

- The closure torque can be programmed individually for every closure operation. For extra security, the closure quality can be checked at the end by applying a counter torque.

5

DETECT MISALIGNMENT

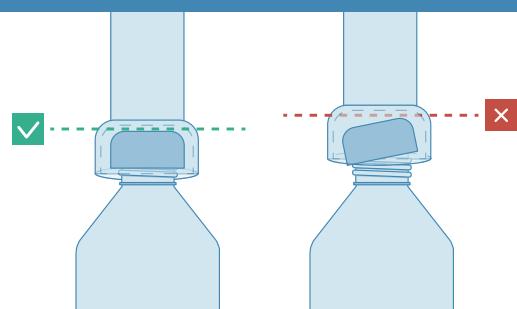

- Information about the final vertical position of the cap at the end of the closure process can be used to detect misaligned caps.

ALL LINEAR MOTION FROM A SINGLE SOURCE

LinMot Europa

NTI AG - LinMot & MagSpring
Bodenaeckerstrasse 2
CH-8957 Spreitenbach
Switzerland

☎ +41 (0)56 419 91 91
🖨 +41 (0)56 419 91 92

✉ office@linmot.com
🏠 www.linmot.com

LinMot USA

LinMot USA, Inc.
N1922 State Road 120, Unit 1
Lake Geneva, WI 53147
United States

☎ 262-743-2555

✉ usasales@linmot.com
🏠 www.linmot-usa.com

LinMot®

