

MOTOR CABLES FOR STANDARD AND LINEAR ROTARY MOTORS

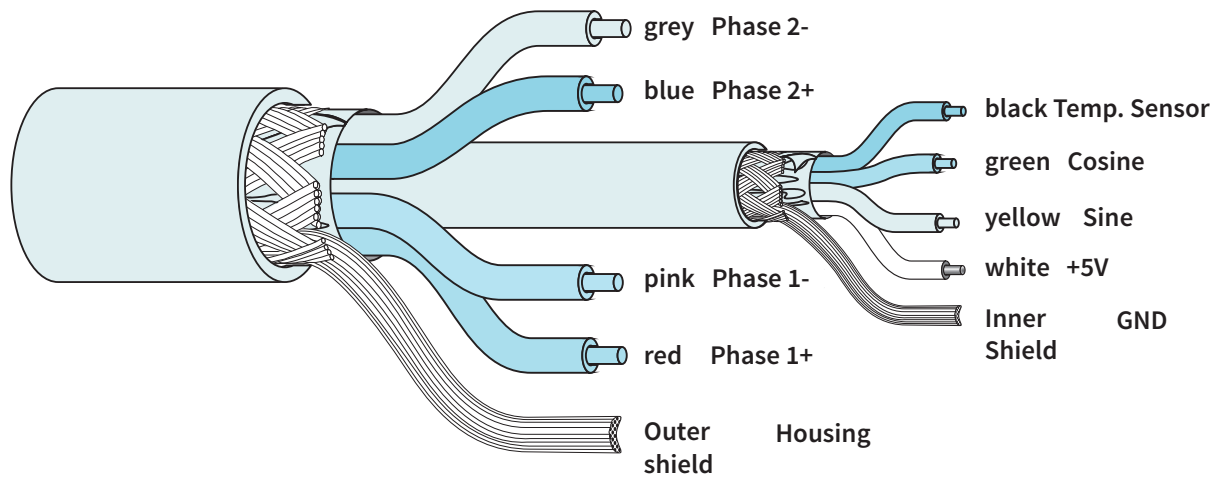

- ✓ Hybrid cables for phases and motor feedback
- ✓ Standard cables for fixed installation
- ✓ High-flex cables for cable chain applications
- ✓ Robot cables for torsional loads
- ✓ Prefabricated motor cables

For type P0x and PR linear motors, one single cable is sufficient to connect the motor and drive. This motor cable contains the motor phases and sensor signals for the position measurement integrated in the motor. The double shielding in the cable (see illustration) ensures that the linear motor can operate without interference with a cable up to 30 m long.



Single-cable concept for type P0x linear motors and PR01 motors

TYPES OF MOTOR CABLES

The abbreviations K, KS, KR, and KF specify the available types of the cables.

The standard type K motor cable is suitable for stationary cable routing. It is used wherever the motor cable is fixed and not subject to any motion.

The high-flex trailing chain KS motor cable is suitable for applications where the motor cable moves, where the cable is routed through a cable carrier and undergoes a roll-up motion.

If the motor cable is subject to a torsional motion, then the special type KR robot cable should be used. In order to protect the robot cable from mechanical damage, it should be routed through a suitable cable tube.

A ribbon cable is with the designation KF is available for the P02-23Sx80 short motor. The ribbon cable can be subjected to roll-up motion, just like the high-flex cable.

MOTOR CABLE BY LENGTH

LinMot motor cables are available by length in versions K, KS, and KR. The cable can be cut to the desired length or ordered in large quantities on rolls.

LinMot carries all of the motor plugs for customers to assemble their own motor cables. The individual connections for customer-assembled motor cables should be checked carefully for short circuits and correct configuration prior to commissioning. The insulation strength between individual conductors must be tested with a test voltage of 1500VDC.

PREFABRICATED MOTOR CABLES

Fully assembled motor cables can be shipped in lengths up to 30 m. Order the motor cable in the desired length together with the matching motor plugs (assembled). Longer cables can also be assembled after consultation with LinMot.

Prefabricated motor cables with the most commonly used plug combinations can be shipped from stock in standard lengths.

LinMot motor cables are produced using only crimped contacts and are tested under high voltage prior to shipment.

MOTOR CABLES FOR STANDARD MOTORS & SHORT TYPE MOTORS

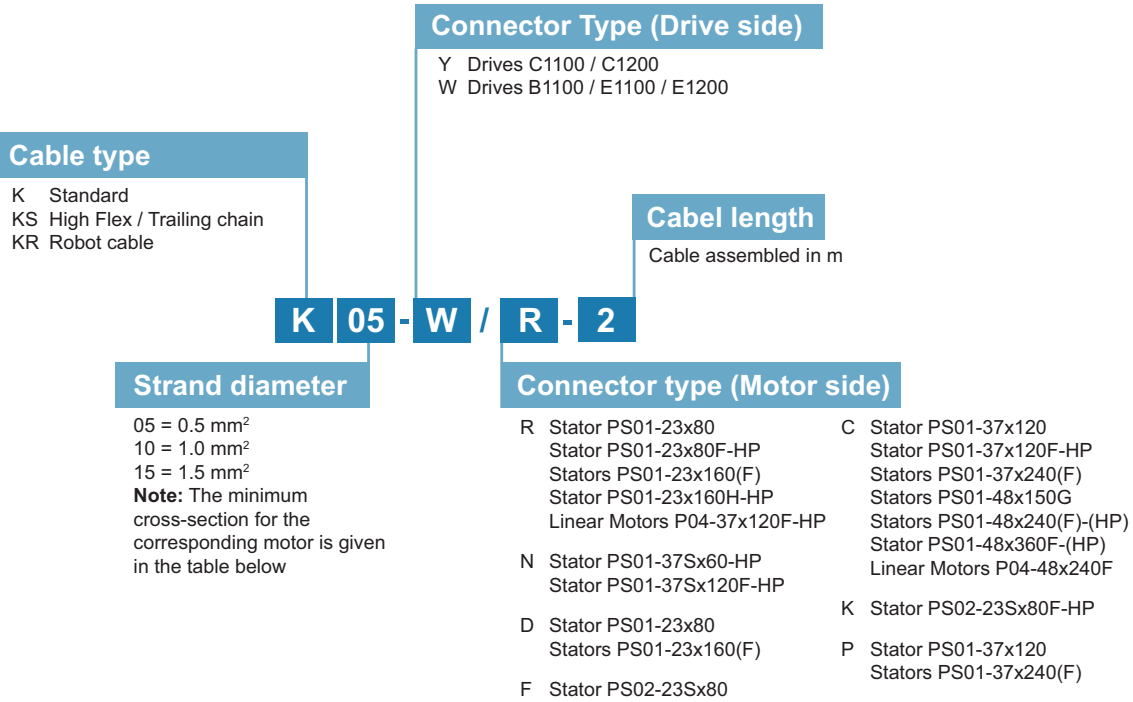

Minimum Strand Diameter						
	Max. Cont. Force [A rms]		Strand diameter according to DIN		Strand diameter according to UL	
	Passive cooling	Fan cooling	Passive cooling	Fan cooling	Passive cooling	Fan cooling
PS01-23x80	0.6	1.1	K(x)05	K(x)05	K(x)05	K(x)05
PS01-23x80F-HP	1.2	1.0	K(x)05	K(x)05	K(x)05	K(x)05
PS02-23Sx80	0.6	1.0	K(x)05	K(x)05	K(x)05	K(x)05
PS02-23Sx80F-HP	1.1	2.0	K(x)05	K(x)05	K(x)05	K(x)05
PS01-23x160	0.6	1.0	K(x)05	K(x)05	K(x)05	K(x)05
PS01-23x160F	0.8	1.6	K(x)05	K(x)05	K(x)05	K(x)05
PS01-23x160H-HP	1.8	2.7	K(x)05	K(x)05	K(x)05	K(x)05
PS01-37Sx60-HP	0.9	1.8	K(x)05	K(x)05	K(x)05	K(x)05
PS01-37x120	1.5	1.9	K(x)05	K(x)05	K(x)05	K(x)05
PS01-37x120F-HP	2.1	3.8	K(x)05	K(x)05	K(x)05	K(x)05
PS01-37Sx120F-HP	1.5	3.0	K(x)05	K(x)05	K(x)05	K(x)05
PS01-37x240	1.0	1.8	K(x)05	K(x)05	K(x)05	K(x)05
PS01-37x240F	1.5	2.8	K(x)05	K(x)05	K(x)05	K(x)05
PS01-48x150G-HP	6.7	11	K(x)05	K(x)05	K(x)10	K(x)15*
PS01-48x240	2.7	4.7	K(x)05	K(x)05	K(x)05	K(x)10
PS01-48x240F	4.8	8.3	K(x)05	K(x)05	K(x)10	K(x)15
PS01-48x240F-HP	7.7	13	K(x)05	K(x)10	K(x)15	K(x)15**
PS01-48x360F	4.6	7.9	K(x)05	K(x)05	K(x)10	K(x)15
PS01-48x360F-HP	7.7	13	K(x)05	K(x)10	K(x)15	K(x)15***
P04-37x120F-HP	2.9	4.0	K(x)05	K(x)05	K(x)05	K(x)05
P04-48x240F	4.7	8.3	K(x)05	K(x)05	K(x)10	K(x)15

*Up to max. cont. force 156 N rms
 **Up to max. cont. force 220 N rms
 ***Up to max. cont. force 325 N rms

14

MOTOR CABLES FOR LINEAR ROTARY MOTORS

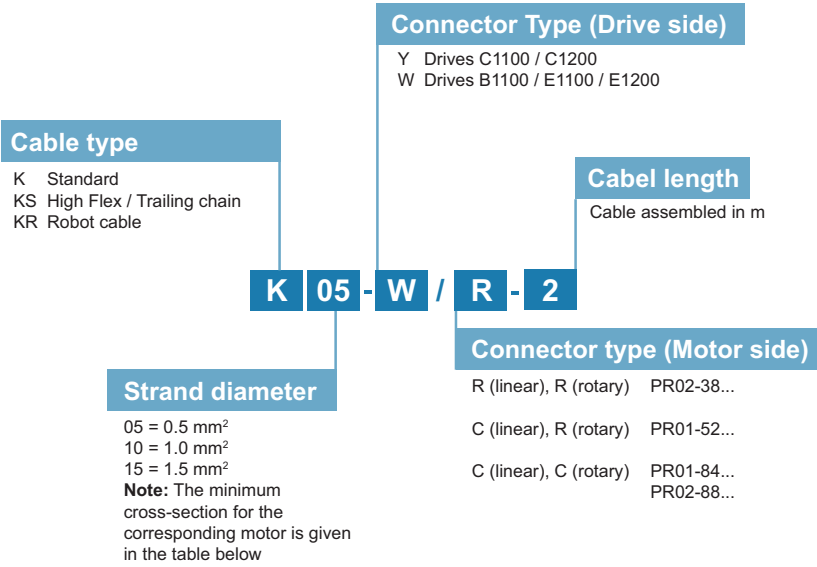

Minimum Strand Diameter (Linear Unit)						
	Max. Cont. Force [A rms]		Strand diameter according to DIN		Strand diameter according to UL	
	Passive cooling	Fan cooling	Passive cooling	Fan cooling	Passive cooling	Fan cooling
PR01-52x40-R/37x120F-HP-C-80 (-L)	2.1	3.8	K(x)05	K(x)05	K(x)05	K(x)05
PR01-52x60-R/37x120F-HP-C-100 (-L)	2.1	3.8	K(x)05	K(x)05	K(x)05	K(x)05
PR01-52x60-R/37x120F-HP-C-150 (-L)	2.1	3.8	K(x)05	K(x)05	K(x)05	K(x)05
PR01-84x80-C/48x240F-C-100 (-L)	4.8	8.3	K(x)05	K(x)05	K(x)10	K(x)15
PR01-84x80-C/48x240F-C-150 (-L)	4.8	8.3	K(x)05	K(x)05	K(x)10	K(x)15
PR01-84x80-C/48x240F-C-300 (-L)	4.8	8.3	K(x)05	K(x)05	K(x)10	K(x)15
PR01-84x80-C/48x360F-C-100 (-L)	4.6	7.9	K(x)05	K(x)05	K(x)10	K(x)15
PR01-84x80-C/48x360F-C-150 (-L)	4.6	7.9	K(x)05	K(x)05	K(x)10	K(x)15
PR01-84x80-SSC-C/48x240F-C-150 (-L)	4.8	8.3	K(x)05	K(x)05	K(x)10	K(x)15
PR01-84x80-SSC-C/48x240F-C-300-L	4.8	8.3	K(x)05	K(x)05	K(x)10	K(x)15
PR01-84x80-SSC-C/48x360F-C-150 (-L)	4.6	7.9	K(x)05	K(x)05	K(x)10	K(x)15
PR01-52x60-R/37x120F-HP-C-100-G...	2.1	3.8	K(x)05	K(x)05	K(x)05	K(x)15
PR01-84x80-C/48x240F-C-150-G...	4.8	8.3	K(x)05	K(x)05	K(x)10	K(x)15
PR01-84x80-C/48x360F-C-150-G...	4.6	7.9	K(x)05	K(x)05	K(x)10	K(x)15

Minimum Strand Diameter (Rotary Unit)						
	Max. Cont. Force [A rms]		Strand diameter according to DIN		Strand diameter according to UL	
	Passive cooling	Fan cooling	Passive cooling	Fan cooling	Passive cooling	Fan cooling
PR01-52x40-R/37x120F-HP-C-80 (-L)	1.2	1.8	K(x)05	K(x)05	K(x)05	K(x)05
PR01-52x60-R/37x120F-HP-C-100 (-L)	2.1	3.1	K(x)05	K(x)05	K(x)05	K(x)05
PR01-52x60-R/37x120F-HP-C-150 (-L)	2.1	3.1	K(x)05	K(x)05	K(x)05	K(x)05
PR01-84x80-C/48x240F-C-100 (-L)	3.9	5.5	K(x)05	K(x)05	K(x)05	K(x)10
PR01-84x80-C/48x240F-C-150 (-L)	3.9	5.5	K(x)05	K(x)05	K(x)05	K(x)10
PR01-84x80-C/48x240F-C-300 (-L)	3.9	5.5	K(x)05	K(x)05	K(x)05	K(x)10
PR01-84x80-C/48x360F-C-100 (-L)	3.9	5.5	K(x)05	K(x)05	K(x)05	K(x)10
PR01-84x80-C/48x360F-C-150 (-L)	3.9	5.5	K(x)05	K(x)05	K(x)05	K(x)10
PR01-84x80-SSC-C/48x240F-C-150 (-L)	3.9	5.5	K(x)05	K(x)05	K(x)05	K(x)10
PR01-84x80-SSC-C/48x240F-C-300-L	3.9	5.5	K(x)05	K(x)05	K(x)05	K(x)10
PR01-84x80-SSC-C/48x360F-C-150 (-L)	3.9	5.5	K(x)05	K(x)05	K(x)05	K(x)10
PR01-52x60-R/37x120F-HP-C-100-G...	2.1	3.1	K(x)05	K(x)05	K(x)05	K(x)10
PR01-84x80-C/48x240F-C-150-G...	3.9	5.5	K(x)05	K(x)05	K(x)05	K(x)10
PR01-84x80-C/48x360F-C-150-G...	3.9	5.5	K(x)05	K(x)05	K(x)05	K(x)10

MOTOR CABLES FOR STAINLESS STEEL LINEAR MOTORS

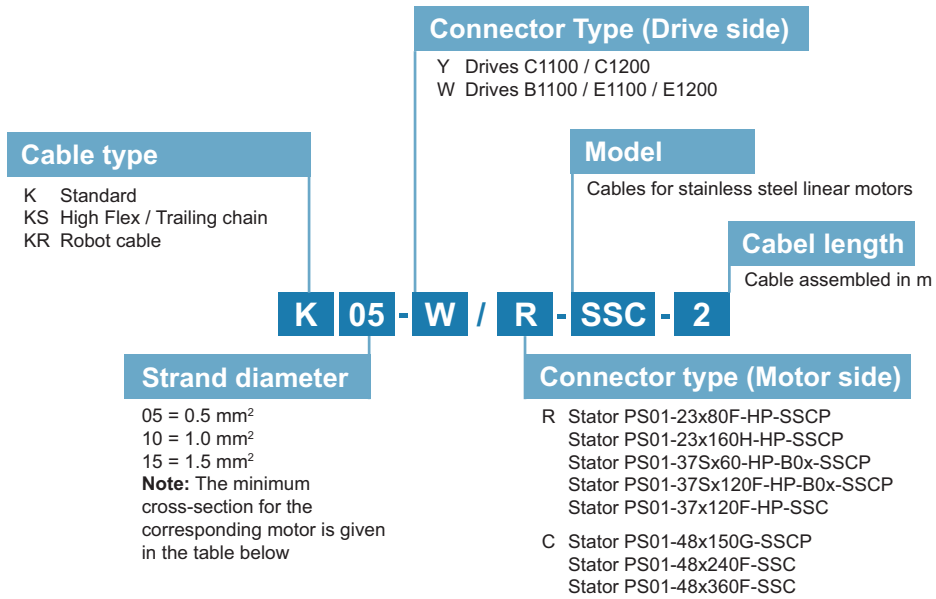

Minimum Strand Diameter						
	Max. Cont. Force [A rms]		Strand diameter according to DIN		Strand diameter according to UL	
	Passive cooling	Fluid cooling	Passive cooling	Fluid cooling	Passive cooling	Fluid cooling
PS01-37x120F-HP-SSC	1.3	3.4	K(x)05	K(x)05	K(x)05	K(x)05
PS01-48x150G-HP-SSCP	5.5	8.8	K(x)05	K(x)05	K(x)05	K(x)15
PS01-48x240F-SSC	3.3	9.2	K(x)05	K(x)05	K(x)05	K(x)15*
PS01-48x360F-SSC	3.4	9.4	K(x)05	K(x)05	K(x)05	K(x)15**

*Up to max. cont. force 230 N rms
 **Up to max. cont. force 333 N rms

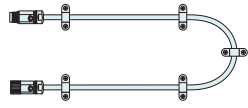
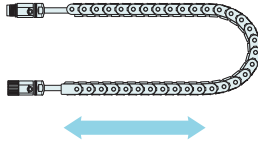
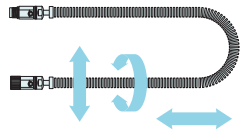
CABLES FOR STANDARD- AND LINEAR ROTARY MOTORS						
	Standard Motor Cable		Trailing Chain Cable		Robot Cable	
						
Cable type	K05-04/05 (1V1)	K15-04/05 (1V1)	KS05-04/05 (1V1)	KS10-04/05 (1V1)	KR05-04/05 (1V1)	KR10-04/05 (1V1)
Item-No.	0150-4233	0150-4234	0150-4235	0150-4236	0150-4237	0150-4238
Wire cross-section Motor phases	0.5 mm ² (AWG20)	1.5 mm ² (AWG16)	0.5 mm ² (AWG20)	1.0 mm ² (AWG18)	0.5 mm ² (AWG20)	1.0 mm ² (AWG18)
Wire cross-section Sensor signal	0.34 mm ² (AWG22)		0.34 mm ² (AWG22)		0.34 mm ² (AWG22)	
Wire cross-section Inner Filler	0.14 mm ² (AWG26)		0.14 mm ² (AWG26)		0.14 mm ² (AWG26)	
Material Wire insulation	PUR	TPE-U	TPE-E		TPE-E	
Material Cable sheath	PUR		PUR		PUR	
Colour Cable sheath	Black		Black		Black	
Cable cross section	9.2 mm (0.35 in)	11.8 mm (0.46 in)	9.5 mm (0.38 in)	10.8 mm (0.42 in)	9.9 mm (0.38 in)	11.1 mm (0.43 in)
Weight	96 kg/km	185 kg/km	121 kg/km	154 kg/km	129 kg/km	153 kg/km
Approvals	(-)	UL / CSA 300V E467697	UL / CSA 300V E172204		UL / CSA 300V E172204	
AWM-Style	20233		20233		20233	
Minimum bend- ing radius static	25 mm (1 in)	50 mm (2 in)	30 mm (1.2 in)	50 mm (2 in)	40 mm (1.6 in)	50 mm (2 in)
Minimum bend- ing radius moving	Not suitable for applications With moving motor cable		60 mm (2.4 in) No Torsion	100 mm (4 in) No Torsion	80 mm (3.2 in) Max. Torsion: ±270° pro 0.5 m	100 mm (4 in) Max. Torsion: ±270° pro 0.5 m
Temperature range	-40°...+80°C		-40°...+80°C		-40°...+80°C	
Oil resistance	very good acc. DIN VDE 0282 Part 10 + HD 22.10		very good acc. DIN VDE 0282 Part 10 + HD 22.10		very good acc. DIN VDE 0282 Part 10 + HD 22.10	
Chemical resistance	good to acids, alkalis, solvents, hydraulic fluids, etc.		good to acids, alkalis, solvents, hydraulic fluids, etc.		good to acids, alkalis, solvents, hydraulic fluids, etc.	



CABLES FOR SHORT TYPE MOTORS						
	Trailing Chain Cable			Robot Cable		Flat Cable
Cable type	KS03-09**	KS05-09**	KS05-04/05	KR03-09**	KR05-04/05	KF02-D15/F-...
Item-No.	0150-2182	0150-2931	0150-1938	0150-2801	0150-1846	assembled
Wire cross-section Motor phases	0.34 mm ² (AWG22)	0.5 mm ² (AWG20)	0.5 mm ² (AWG20)	0.34 mm ² (AWG22)	0.5 mm ² (AWG20)	(-)
Wire cross-section Sensor signal		0.14 mm ² (AWG26)		0.14 mm ² (AWG26)		(-)
Wire cross-section Inner Filler	(-)	(-)	0.14 mm ² (AWG26)	(-)	(-)	(-)
Material Wire insulation		TPE-E		TPE-E		Polyester
Material Cable sheath		PUR		PUR		(-)
Colour Cable sheath		Black		Black		White
Cable cross section	6.7 mm (0.26 in)	7.6 mm (0.29 in)	9.5 mm (0.38 in)	7.4 mm (0.29 in)	9.7 mm (0.38 in)	17.8x0.2 mm (0.7x0.008 in)
Weight	64 kg/km	83 kg/km	115 kg/km	69 kg/km	109 kg/km	(-)
Approvals		UL / CSA 300V E172204		UL / CSA 300V E172204		(-)
AWM-Style	21198	21198	20235	21198	20233	(-)
Minimum bending radius static	25 mm (1 in)	25 mm (1 in)	30 mm (1.2 in)	30 mm (1.2 in)	40 mm (1.6 in)	foldable
Minimum bending radius moving	50 mm (2 in)	55 mm (2.2 in)	60 mm (2.4 in) No Torsion	60 mm (2.4 in) Max. Torsion: ±180° pro 0.5 m*	80 mm (3.2 in) Max. Torsion: ±270° pro 0.5 m	25 mm
Temperature range		-40°...+80°C		-40°...+80°C		-55°...+105°C
Oil resistance		very good acc. DIN VDE 0282 Part 10 + HD 22.10		very good acc. DIN VDE 0282 Part 10 + HD 22.10		(-)
Chemical resistance		good to acids, alkalis, solvents, hydraulic fluids, etc.		good to acids, alkalis, solvents, hydraulic fluids, etc.		(-)

* ±270° / 0.5 m permitted for initialization.

** Max. length 6 m

(Longer cable lengths can result in losses in positioning accuracy, in the operating behaviour and in the interference sensitivity of the motors. Extensions up to 50 m can be realised with cables K05-04/05 1V1 or KS05-04/05 1V1.)

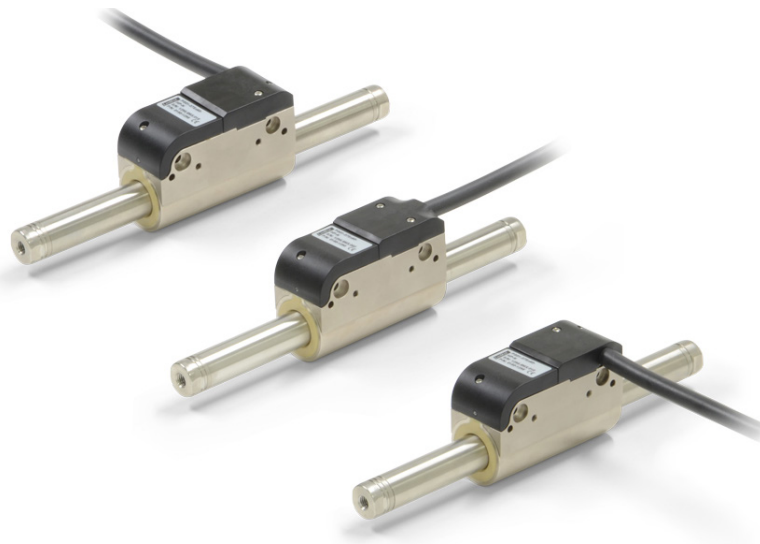

ASSEMBLED CABLES FOR STANDARD & LINEAR ROTARY MOTORS

MOTOR CABLE FOR LINEAR MOTORS WITH C CONNECTOR		
Item	Description	Item-No.
K05-W/C-2	Motor cable W/C, 2 m	0150-2123
K05-W/C-4	Motor cable W/C, 4 m	0150-2124
K05-W/C-6	Motor cable W/C, 6 m	0150-2125
K05-W/C-8	Motor cable W/C, 8 m	0150-2126
K05-W/C-	Motor cable W/C-, made to measure	0150-3263
K05-Y/C-2	Motor cable Y/C, 2 m	0150-2425
K05-Y/C-4	Motor cable Y/C, 4 m	0150-2426
K05-Y/C-6	Motor cable Y/C, 6 m	0150-2427
K05-Y/C-8	Motor cable Y/C, 8 m	0150-2428
K05-Y-Fe/C-	Motor cable Y-Fe/C-, made to measure	0150-3502
K05-HI/C-2	Motor cable HI/C, 2 m	0150-2452
K05-HI/C-4	Motor cable HI/C, 4 m	0150-2451
K05-C/C-	Motor cable C/C-, made to measure	0150-3617
K05-OE/C-	Motor cable OE/C-, made to measure, open end	0150-3604
K15-W/C-2	Motor cable W/C, 2 m	0150-1811
K15-W/C-4	Motor cable W/C, 4 m	0150-1801
K15-W/C-5	Motor cable W/C, 5 m	0150-1849
K15-W/C-6	Motor cable W/C, 6 m	0150-1802
K15-W/C-8	Motor cable W/C, 8 m	0150-1803
K15-W/C-	Motor cable W/C-, made to measure	0150-3131
K15-Y/C-2	Motor cable Y/C, 2 m	0150-2429
K15-Y/C-4	Motor cable Y/C, 4 m	0150-2430
K15-Y/C-6	Motor cable Y/C, 6 m	0150-2431
K15-Y/C-8	Motor cable Y/C, 8 m	0150-2432
K15-Y-Fe/C-	Motor cable Y-Fe/C-, made to measure	0150-3506
K15-HI/C-2	Motor cable HI/C, 2 m	0150-2453
K15-HI/C-4	Motor cable HI/C, 4 m	0150-2458
K15-C/C-	Motor cable C/C-, made to measure	0150-3250
K15-OE/C-	Motor cable OE/C-, made to measure, open end	0150-5689
KS05-W/C-4	Trailing chain cable W/C, 4 m	0150-2127
KS05-W/C-6	Trailing chain cable W/C, 6 m	0150-2128
KS05-W/C-8	Trailing chain cable W/C, 8 m	0150-2129
KS05-W/C-	Trailing chain cable W/C-, made to measure	0150-3204
KS05-Y/C-4	Trailing chain cable Y/C, 4 m	0150-2436
KS05-Y/C-6	Trailing chain cable Y/C, 6 m	0150-2437
KS05-Y/C-8	Trailing chain cable Y/C, 8 m	0150-2438
KS05-Y-Fe/C-	Trailing chain cable Y-Fe/C-, made to measure	0150-3508
KS05-C/C-2	Trailing chain cable C/C, 2 m	0150-1827
KS05-C/C-4	Trailing chain cable C/C, 4 m	0150-1828
KS05-C/C-	Trailing chain cable C/C-, made to measure	0150-3207
KS05-A-Fe/C-	Trailing chain cable A-Fe/C-, made to measure	0150-3554
KS10-W/C-4	Trailing chain cable W/C, 4 m	0150-1807
KS10-W/C-5	Trailing chain cable W/C, 5 m	0150-1860
KS10-W/C-6	Trailing chain cable W/C, 6 m	0150-1858
KS10-W/C-8	Trailing chain cable W/C, 8 m	0150-1808
KS10-W/C-	Trailing chain cable W/C-, made to measure	0150-3139

ASSEMBLED CABLES FOR STANDARD & LINEAR ROTARY MOTORS

KS10-Y/C-4	Trailing chain cable Y/C, 4 m	0150-2439
KS10-Y/C-6	Trailing chain cable Y/C, 6 m	0150-2440
KS10-Y/C-8	Trailing chain cable Y/C, 8 m	0150-2441
KS10-Y-Fe/C-	Trailing chain cable Y-Fe/C-, made to measure	0150-3511
KS10-C/C-2	Trailing chain cable C/C, 2 m	0150-1816
KS10-C/C-4	Trailing chain cable C/C, 4 m	0150-1817
KS10-C/C-	Trailing chain cable C/C-, made to measure	0150-3206
KS10-R/C-	Trailing chain cable R/C-, made to measure	0150-3665
KR05-W/C-	Motor cable W/C-, made to measure	0150-3644
KR05-Y-Fe/C-	Motor cable Y-Fe/C-, made to measure	0150-3513
KR05-C/C-	Motor cable C/C-, made to measure	0150-3255
KR05-R/C-	Motor cable R/C-, made to measure	0150-5639
KR10-W/C-	Motor cable W/C-, made to measure	0150-3199
KR10-Y-Fe/C-	Motor cable Y-Fe/C-, made to measure	0150-3515
KR10-C/C-	Motor cable C/C-, made to measure	0150-3222

MOTOR CABLE FOR LINEAR MOTORS WITH R CONNECTOR

Item	Description	Item-No.
K05-W/R-2	Motor cable W/R, 2 m	0150-2119
K05-W/R-3	Motor cable W/R, 3 m	0150-2459
K05-W/R-4	Motor cable W/R, 4 m	0150-2120
K05-W/R-6	Motor cable W/R, 6 m	0150-2121
K05-W/R-8	Motor cable W/R, 8 m	0150-2122
K05-W/R-10	Motor cable W/R, 10 m	0150-2132
K05-W/R-	Motor cable W/R-, made to measure	0150-3262
K05-Y/R-2	Motor cable Y/R, 2 m	0150-2421
K05-Y/R-4	Motor cable Y/R, 4 m	0150-2422
K05-Y/R-6	Motor cable Y/R, 6 m	0150-2423
K05-Y/R-8	Motor cable Y/R, 8 m	0150-2424
K05-W/R-	Motor cable W/R-, made to measure	0150-3262
K05-HI/R-2	Motor cable HI/R, 2 m	0150-2449
K05-HI/R-4	Motor cable HI/R, 4 m	0150-2450
K05-C/R-	Motor cable C/R-, made to measure	0150-3546
K05-R/R-	Motor cable R/R-, made to measure	0150-3216
K05-OE/R-	Motor cable OE/R-, made to measure, open end	0150-3585
K15-W/R-	Motor cable W/R-, made to measure	0150-3275
K15-Y-Fe/R-	Motor cable Y-Fe/R-, made to measure	0150-3678
KS05-W/R-4	Trailing chain cable W/R, 4 m	0150-2106
KS05-W/R-6	Trailing chain cable W/R, 6 m	0150-2131
KS05-W/R-8	Trailing chain cable W/R, 8 m	0150-2107
KS05-W/R-	Trailing chain cable W/R-, made to measure	0150-3256
KS05-W/R-SSC-	Trailing chain cable W/R-SSC-, made to measure	0150-3583

ASSEMBLED CABLES FOR STANDARD & LINEAR ROTARY MOTORS

KS05-Y/R-4	Trailing chain cable Y/R, 4 m	0150-2433
KS05-Y/R-6	Trailing chain cable Y/R, 6 m	0150-2434
KS05-Y/R-8	Trailing chain cable Y/R, 8 m	0150-2435
KS05-Y-Fe/R-	Trailing chain cable Y-Fe/R-, made to measure	0150-3507
KS05-R/R-2	Trailing chain cable R/R, 2 m	0150-1838
KS05-R/R-4	Trailing chain cable , 4 m	0150-1839
KS05-R/R-	Trailing chain cable R/R-, made to measure	0150-3217
KS05-R/R-SSC-	Trailing chain cable R/R-SSC-, made to measure	0150-3730
KS05-A-Fe/R-	Trailing chain cable A-Fe/R-, made to measure	0150-3555
KS10-W/R-	Trailing chain cable W/R-, made to measure	0150-3288
KS10-Y-Fe/R-	Trailing chain cable Y-Fe/R-, made to measure	0150-3510
KS10-R/R-	Trailing chain cable R/R-, made to measure	0150-3707
KR05-W/R-	Robot cable W/R-, made to measure	0150-3336
KR05-Y-Fe/R-	Robot cable Y-Fe/R-, made to measure	0150-3512
KR05-R/R-	Robot cable R/R-, made to measure	0150-3218

ASSEMBLED CABLES FOR STAINLESS STEEL MOTORS

MOTOR CABLE FOR LINEAR MOTORS WITH R-SSC CONNECTORS (STAINLESS STEEL)		
Item	Description	Item-No.
K05-W/R-SSC-	Motor cable W/R-SSC-, made to measure	0150-3586
K05-Y-Fe/R-SSC-	Motor cable Y-Fe/R-SSC-, made to measure	0150-3715
KS05-W/R-SSC-2	Trailing chain cable W/R-SSC, 2 m	0150-2683
KS05-W/R-SSC-4	Trailing chain cable W/R-SSC, 4 m	0150-2684
KS05-W/R-SSC-6	Trailing chain cable W/R-SSC, 6 m	0150-2685
KS05-W/R-SSC-8	Trailing chain cable W/R-SSC, 8 m	0150-2686
KS05-Y/R-SSC-2	Trailing chain cable Y/R-SSC, 2 m	0150-2687
KS05-Y/R-SSC-4	Trailing chain cable Y/R-SSC, 4 m	0150-2688
KS05-Y/R-SSC-6	Trailing chain cable Y/R-SSC, 6 m	0150-2689
KS05-Y/R-SSC-8	Trailing chain cable Y/R-SSC, 8 m	0150-2690
KS05-Y-Fe/R-SSC-	Trailing chain cable Y-Fe/R-SSC-, made to measure	0150-3646
KS05-A-Fe/R-SSC-	Trailing chain cable A-Fe/R-SSC-, made to measure	0150-4936
KS05-R-SSC/R-SSC-	Trailing chain cable R-SSC/R-SSC-, made to measure	0150-5593
KS05-OE/R-SSC-	Trailing chain cable OE/R-SSC-, made to measure, open end	0150-5627
KS10-W/R-SSC-	Trailing chain cable W/R-SSC-, made to measure	0150-3359
KS10-Y-Fe/R-SSC-	Trailing chain cable Y-Fe/R-SSC-	0150-3547
KR05-W/R-SSC-	Robot cable W/R-SSC-	0150-3587
KR05-Y-Fe/R-SSC-	Robot cable Y-Fe/R-SSC-	0150-4364
KR05-R/R-SSC-	Robot cable R/R-SSC-, made to measure	0150-4369
KR05-R-SSC/R-SSC-	Robot cable R-SSC/R-SSC-, made to measure	0150-5547

ASSEMBLED CABLES FOR STAINLESS STEEL MOTORS

MOTOR CABLE FOR LINEAR MOTORS WITH C-SSC CONNECTORS (STAINLESS STEEL)		
Item	Description	Item-No.
K15-W/C-SSC-	Motor cable W/C-SSC-, made to measure	0150-3539
K15-Y-Fe/C-SSC-	Motor cable Y-Fe/C-SSC-, made to measure	0150-3630
K15-C-SSC/C-SSC-	Motor cable C-SSC/C-SSC-, made to measure	0150-3403
KS10-W/C-SSC-2	Trailing chain cable W/C-SSC, 2 m	0150-2675
KS10-W/C-SSC-4	Trailing chain cable W/C-SSC, 4 m	0150-2676
KS10-W/C-SSC-6	Trailing chain cable W/C-SSC, 6 m	0150-2677
KS10-W/C-SSC-8	Trailing chain cable W/C-SSC, 8 m	0150-2678
KS10-W/C-SSC-	Trailing chain cable W/C-SSC-, made to measure	0150-3358
KS10-Y/C-SSC-2	Trailing chain cable Y/C-SSC, 2 m	0150-2679
KS10-Y/C-SSC-4	Trailing chain cable Y/C-SSC, 4 m	0150-2680
KS10-Y/C-SSC-6	Trailing chain cable Y/C-SSC, 6 m	0150-2681
KS10-Y/C-SSC-8	Trailing chain cable Y/C-SSC, 8 m	0150-2682
KS10-Y-Fe/C-SSC-	Trailing chain cable Y-Fe/C-SSC-, made to measure	0150-3574
KS10-C/C-SSC-	Trailing chain cable C/C-SSC-, made to measure	0150-3368
KS10-C-SSC/C-SSC-	Trailing chain cable C-SSC/C-SSC-, made to measure	0150-5688
KR10-W/C-SSC-	Robot cable W/C-SSC-, made to measure	0150-3536
KR10-Y-Fe/C-SSC-	Robot cable Y-Fe/C-SSC-, made to measure	0150-2890
KR10-C/C-SSC-	Robot cable C/C-SSC-, made to measure	0150-3405
KR10-C-SSC/C-SSC-	Robot cable C-SSC/C-SSC-, made to measure	0150-3629

ASSEMBLED CABLES FOR SHORT TYPE MOTORS

MOTOR CABLE FLAT FOR SHORT TYPE MOTORS P02-23Sx80-F		
Item	Description	Item-No.
KF02-D15/F-0.08	Flat cable 0.08m, für PS02-23Sx80-F	0150-2150
KF02-D15/F-0.16	Flat cable 0.16m, für PS02-23Sx80-F	0150-2156
KF02-D15/F-0.32	Flat cable 0.32m, für PS02-23Sx80-F	0150-2152
KF02-D15/F-0.48	Flat cable 0.48m, für PS02-23Sx80-F	0150-2154
KF02-D15/F-0.70	Flat cable 0.70m, für PS02-23Sx80-F	0150-2158
K05-D/D15-1	Adapter cable D/D15, 1 m	0150-1936
K05-W/D15-	Motor cable W/D15-, made to measure	0150-3333
K05-Y-Fe/D15-	Motor cable Y-Fe/D15-, made to measure	0150-3504
KS05-A-Fe/D15-	Trailing chain cable A-Fe/D15-, made to measure	0150-3719
KS05-Y-Fe/D15-	Trailing chain cable Y-Fe/D15-, made to measure	0150-3683

MOTOR CABLE FOR SHORT TYPE MOTORS P02-23Sx80-F-HP-K		
Item	Description	Item-No.
KS03-W-Fe/K-2	Trailing chain cable W-Fe/K 2 m	0150-2187
KS03-W-Fe/K-4	Trailing chain cable W-Fe/K 4 m	0150-2369
KS03-W-Fe/K-6	Trailing chain cable W-Fe/K 6 m	0150-2370
KS03-W-Fe/K-	Trailing chain cable W-Fe/K-, made to measure	0150-3357

ASSEMBLED CABLES FOR SHORT TYPE MOTORS

KS03-Y-Fe/K-2	Trailing chain cable Y-Fe/K, 2 m	0150-2446
KS03-Y-Fe/K-4	Trailing chain cable Y-Fe/K, 4 m	0150-2447
KS03-Y-Fe/K-6	Trailing chain cable Y-Fe/K, 6 m	0150-2448
KS03-Y-Fe/K-	Trailing chain cable Y-Fe/K-, made to measure	0150-3516
KS03-C/K-	Trailing chain cable C/K-, made to measure	0150-3577
KS03-R/K-1	Trailing chain cable R/K 1 m	0150-2185
KS03-R/K-2	Trailing chain cable R/K 2 m	0150-2186
KS03-R/K-	Trailing chain cable R/K-, made to measure	0150-3530
KS03-A-Fe/K-	Trailing chain cable A-Fe/K-, made to measure	0150-3542
KS03-OE/K-	Trailing chain cable OE/K-, made to measure, open end	0150-4764
KR03-W-Fe/K-	Robot cable W-Fe/K-, made to measure	0150-3755
KR03-Y-Fe/K-	Robot cable Y-Fe/K-, made to measure	0150-3718
KR03-R/K-	Robot cable R/K-, made to measure	0150-3754

MOTOR CABLE FOR SHORT TYPE MOTORS P01-37SX...-HP-N

Item	Description	Item-No.
KS03-OE/N-	Trailing chain cable OE/N-, made to measure	0150-6071
KS05-W/N-2	Trailing chain cable W/N, 2 m	0150-2296
KS05-W/N-4	Trailing chain cable W/N, 4 m	0150-2297
KS05-W/N-6	Trailing chain cable W/N, 6 m	0150-2298
KS05-W/N-8	Trailing chain cable W/N, 8 m	0150-2299
KS05-W/N-	Trailing chain cable W/N-, made to measure	0150-3412
KS05-Y/N-2	Trailing chain cable Y/N, 2 m	0150-2442
KS05-Y/N-4	Trailing chain cable Y/N, 4 m	0150-2443
KS05-Y/N-6	Trailing chain cable Y/N, 6 m	0150-2444
KS05-Y/N-8	Trailing chain cable Y/N, 8 m	0150-2445
KS05-Y-Fe/N-	Trailing chain cable Y-Fe/N-, made to measure	0150-3509
KS05-C/N-	Trailing chain cable C/N-, made to measure	0150-3517
KS05-R/N-	Trailing chain cable R/N-, made to measure	0150-3486
KS05-A-Fe/N-	Trailing chain cable A-Fe/N-, made to measure	0150-3551
KS05-OE/N-	Trailing chain cable OE/N-, made to measure	0150-3716
KR05-W/N-	Robot cable W/N-, made to measure	0150-3406
KR05-Y-Fe/N-	Robot cable Y-Fe/N-, made to measure	0150-3514
KR05-R/N-	Robot cable R/N-, made to measure	0150-3757

CABLE PER M FOR STANDARD AND LINEAR ROTARY MOTORS

MOTOR CABLE PER M		
Item	Description	Item-No.
K05-04/05 (1V1)	Motor cable per m, 1V1	0150-4233
K05-04/05-50 (1V1)	Motor cable 50 m roll, 1V1	0150-4241
K05-04/05-100 (1V1)	Motor cable 100 m roll, 1V1	0150-4243
K05-04/05-200 (1V1)	Motor cable 200 m roll, 1V1	0150-4244
K15-04/05 (1V1)	Motor cable per m, 1V1	0150-4234
K15-04/05-50 (1V1)	Motor cable 50 m roll, 1V1	0150-4246
K15-04/05-100 (1V1)	Motor cable 100 m roll, 1V1	0150-4245
KS05-04/05 (1V1)	Trailing chain cable per m, 1V1	0150-4235
KS05-04/05-100 (1V1)	Trailing chain cable 100 m roll, 1V1	0150-4247
KS10-04/05 (1V1)	Trailing chain cable per m, 1V1	0150-4236
KS10-04/05-100 (1V1)	Trailing chain cable 100 m roll, 1V1	0150-4249
KR05-04/05 (1V1)	Robot cable per m, 1V1	0150-4237
KR05-04/05-100 (1V1)	Robot cable 100 m roll, 1V1	0150-4250
KR10-04/05 (1V1)	Robot cable per m, 1V1	0150-4238
KR10-04/05-100 (1V1)	Robot cable 100 m roll, 1V1	0150-4251

CABLE PER M FOR SHORT TYPE MOTORS

MOTOR CABLE PER M		
Item	Description	Item-No.
KS03-09	Trailing chain cable per m (max. 6 m)	0150-2182
KS05-09	Trailing chain cable per m	0150-2931
KS05-04/05	Trailing chain cable per m	0150-1938
KS05-04/05-100	Trailing chain cable 100 m roll	0150-1959
KR03-09	Robot cable per m	0150-2801
KR05-04/05	Robot cable per m	0150-1846
KR05-04/05-100	Robot cable 100 m roll	0150-1847

Y-CONNECTOR

DRIVE SERIES C1100 / C1200

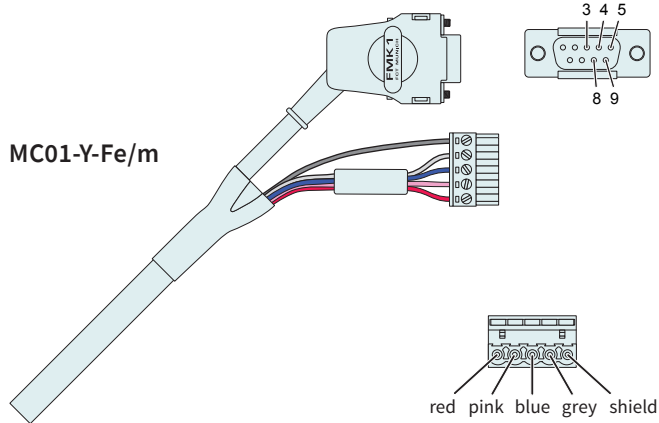

Strand red	Phase 1+	red
Strand pink	Phase 1-	pink
Strand blue	Phase 2+	blue
Strand grey	Phase 2-	grey
3	+5V	white
8	GND	inner Shield
4	Sensor Sine	yellow
9	Sensor Cosine	green
5	Temp. Sensor	black
Shield	Shield	Outer shield

Item	Description	Item-No.
MC01-Y-Fe/m	Motor connector Y-Fe/m	0150-3289
MC01-Y-Fe/m-as (assembled)	Y/m-Connector assembled	0150-3500

W-CONNECTOR

DRIVE SERIES C1100 / C1200

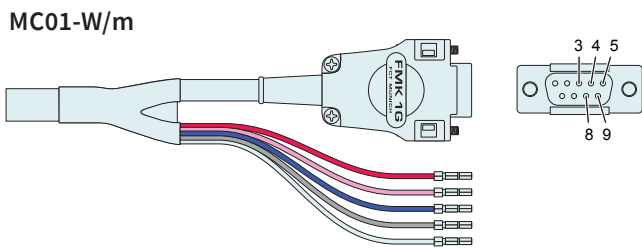

Strand red	Phase 1+	red
Strand pink	Phase 1-	pink
Strand blue	Phase 2+	blue
Strand grey	Phase 2-	grey
3	+5V	white
8	GND	inner Shield
4	Sensor Sine	yellow
9	Sensor Cosine	green
5	Temp. Sensor	black
Shield	Shield	Outer Shield

Item	Description	Item-No.
MC01-W/m	Motor connector W/m	0150-3140
MC01-W/m-as (assembled)	W/m-Connector assembled	0150-3147

A-CONNECTOR

DRIVE SERIES A1100

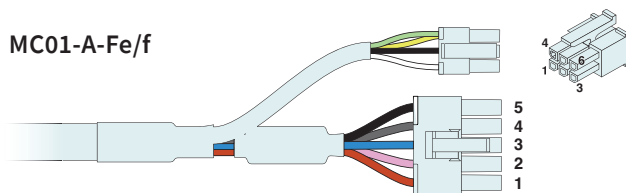

Power

1	Phase 1+	red
2	Phase 1-	pink
3	Phase 2+	blue
4	Phase 2-	grey
5	Shield	Outer Shield

Signal

1	GND	brown (Kx03) / Drain wire inner shield (Kx05)
2	Temp. Sensor	black
3	Sensor Sine	yellow
4	+5V	white
5	n. c.	n. c.
6	Sensor Cosine	green

Item	Description	Item-No.
MC01-A-Fe/f-as	A-Fe/f-connector assembled	0150-3541

R-CONNECTOR

MC01-R/m

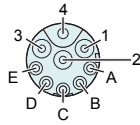
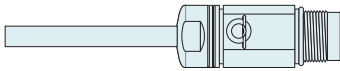

MC01-R/f

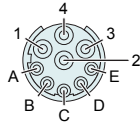
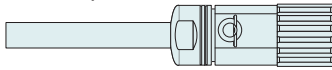

1	Phase 1+	red
2	Phase 1-	pink
3	Phase 2+	blue
4	Phase 2-	grey
A	+5V	white
B	GND	inner Shield
C	Sensor Sine	yellow
D	Sensor Cosine	green
E	Temp. Sensor	black
Housing	Shield	Outer Shield

MC01-F/R

Mounting window

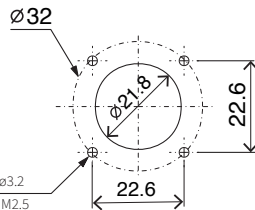
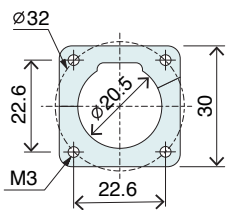

Back panel mounting:ø3.2
Front panel mounting:M2.5

Item	Description	Item-No.
MC01-R/m	Motor connector R/m	0150-3130
MC01-R/f	Motor connector R/f	0150-3129
MC01-R/m-as (assembled)	R/m-Connector assembled	0150-3097
MC01-R/f-as (assembled)	R/f-Connector assembled	0150-3143
MC01-F/R	Mounting flange for connector MC01-R	0150-3253
MC01-R/m-cap (Kappe)	Metal protection cap for R/m (Motor)	0150-3376
MC01-R/f-cap (Kappe)	Metal protection cap for R/f (Cable)	0150-3377

MC01-R/m-cap



MC01-R/f-cap



Material
Zinc die-cast nickel-plated
Seal: Fluororubber

R-CONNECTOR STAINLESS STEEL

MC01-R/m-IP69K-SSC

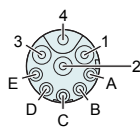
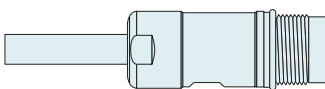

MC01-R/f-IP69K-SSC

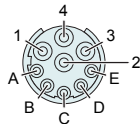
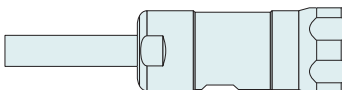

1	Phase 1+	red
2	Phase 1-	pink
3	Phase 2+	blue
4	Phase 2-	grey
A	+5V	white
B	GND	inner Shield
C	Sensor Sine	yellow
D	Sensor Cosine	green
E	Temp. Sensor	black
Housing	Shield	Outer Shield

Item	Description	Item-No.
MC01-R/m-IP69K-SSC	Motor connector R/m-SSC	0150-3381
MC01-R/f-IP69K-SSC	Motor connector R/f, IP69k, SSC	0150-3347
MC01-R/m-IP69K-SSC-as (assembled)	R/m-Connector IP69K, SSC, assembled	0150-3685
MC01-R/f-IP69K-SSC-as (assembled)	R/f-Connector IP69K, SSC, assembled	0150-3343

Material: Stainless steel 1.4404 / AISI 316L

14

C-CONNECTOR

MC01-C/m

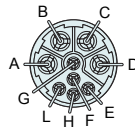
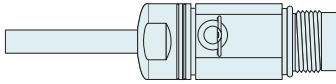

MC01-C/f

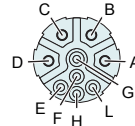
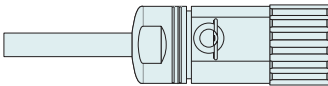

A	Phase 1+	red
B	Phase 1-	pink
C	Phase 2+	blue
D	Phase 2-	grey
E	+5V	white
F	GND	inner Shield
G	Sensor Sine	yellow
H	Sensor Cosine	green
L	Temp. Sensor	black
Housing	Shield	Outer Shield

MC01-F/C

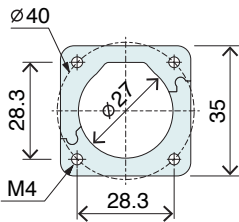

Mounting window

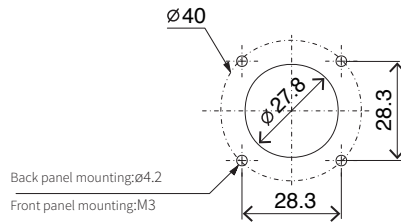

Item	Description	Item-No.
MC01-C/m	Motor connector C/m	0150-3093
MC01-C/f	Motor connector C/f	0150-3080
MC01-C/m-as (assembled)	C/m-Connector assembled	0150-3099
MC01-C/f-as (assembled)	C/f-Connector assembled	0150-3146
MC01-F/C Steckerflansch	Mounting flange for connector MC01-C	0150-3254
MC01-C/m-cap (Kappe)	Metal protection cap for C/m (Motor)	0150-3378
MC01-C/f-cap (Kappe)	Metal protection cap for C/f (Cable)	0150-3379

MC01-C/m-cap



MC01-R/m-cap



Material
Zinc die-cast nickel-plated
Seal: Fluororubber

C-CONNECTOR INOX

MC01-C/m-IP69K-SSC

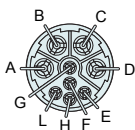
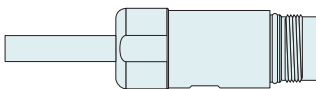

MC01-C/f-IP69K-SSC

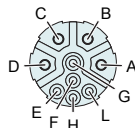
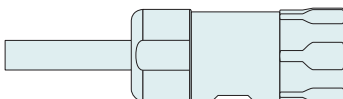

A	Phase 1+	red
B	Phase 1-	pink
C	Phase 2+	blue
D	Phase 2-	grey
E	+5V	white
F	GND	inner Shield
G	Sensor Sine	yellow
H	Sensor Cosine	green
L	Temp. Sensor	black
Housing	Shield	Outer Shield

Material: Stainless steel 1.4404 / AISI 316L

Item	Description	Item-No.
MC01-C/m-IP69K-SSC	Motor connector C/m-SSC	0150-3372
MC01-C/f-IP69K-SSC	Motor connector C/f, IP69K, SSC	0150-3306
MC01-C/m-IP69K-SSC as (assembled)	Motor connector C/m, IP69K, SSC assembled	0150-3404
MC01-C/f-IP69K-SSC as (assembled)	C/f-Connector IP69K, SSC assembled	0150-3325

K-CONNECTOR

MC01-K/f

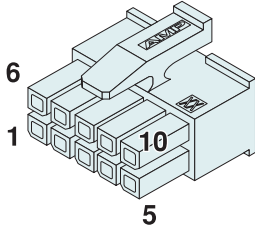
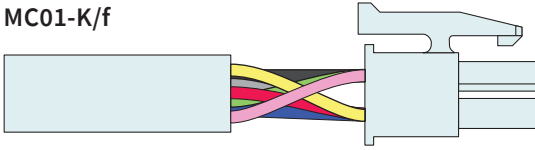

Cable types: KS03-09 (Max. length 6m)

1	Phase 1+	red
2	Phase 2+	blue
4	Phase 1-	pink
5	Phase 2-	grey
9	+5V	white
8	GND	brown
6	Sensor Sine	yellow
7	Sensor Cosine	green
10	Temp. Sensor	black
Shield	Shield	Outer Shield

Item	Description	Item-No.
MC01-K/f	Motor connector K (f)	0150-3345
MC01-K/f-as (assembled)	K/f-Connector assembled	0150-3346

N-CONNECTOR

MC01-N/f

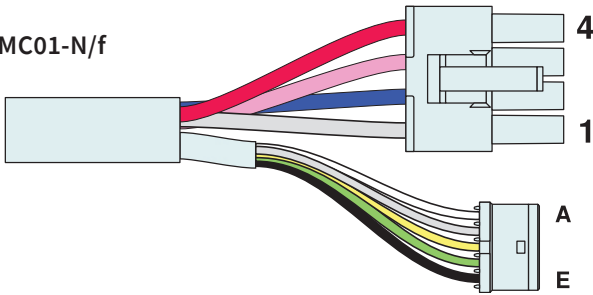

Cable types: KS05-09 (Max. length 6m)
KS05-04/05

4	Phase 1+	red
3	Phase 1-	pink
2	Phase 2+	blue
1	Phase 2-	grey
A	+5V	white
B	GND	inner Shield
C	Sensor Sine	yellow
D	Sensor Cosine	green
E	Temp. Sensor	black
	Housing	Outer shield

Item	Description	Item-No.
MC01-N/f	Motor connector N/f	0150-3407
MC01-N/f-as (assembled)	N/f-Connector assembled	0150-3408

F-CONNECTOR

14

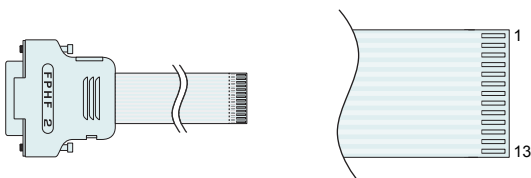

MC01-D15W/f

ZIF-Line Molex
pitch 1.25 mm

12 & 13	Phase 1+	12 & 13
3 & 4	Phase 1-	3 & 4
10 & 11	Phase 2+	10 & 11
1 & 2	Phase 2-	1 & 2
5	+5V	5
7	GND	7
9	Sensor Sine	9
8	Sensor Cosine	8
6	Temp. Sensor	6

Item	Description	Item-No.
KF02-D15/F-...	Flat cable with D15/m-Connector	see section ordering information / Motor cable flat for short motors P02-23Sx80-F



Plugging in or unplugging the flat ribbon cable under voltage can damage the motor and drive.

D-CONNECTOR

MC01-D/m

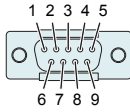
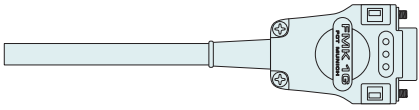

MC01-D/f

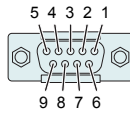
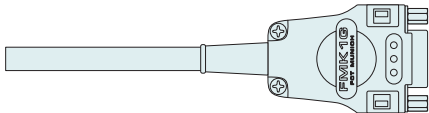

1	Phase 1+	red
6	Phase 1-	pink
2	Phase 2+	blue
7	Phase 2-	grey
3	+5V	white
8	GND	inner Shield
4	Sensor Sine	yellow
9	Sensor Cosine	green
5	Temp. Sensor	black
Housing	Shield	Outer Shield

Item	Description	Item-No.
MC01-D/m	Motor connector D (m)	0150-3024
MC01-D/f	Motor connector D (f)	0150-3025
MC01-D/m-as (assembled)	D/m-Connector assembled	0150-3055
MC01-D/f-as (assembled)	D/f-Connector assembled	0150-3142

P-CONNECTOR

MC01-P/m

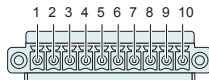
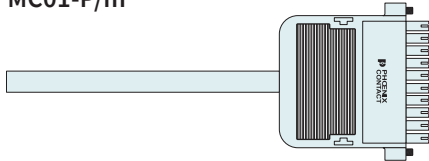

MC01-P/f

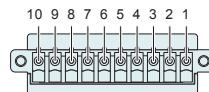
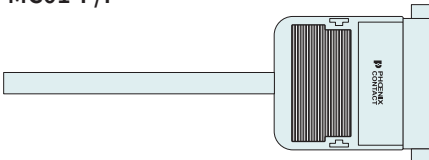

1	Phase 1+	red
2	Phase 1-	pink
3	Phase 2+	blue
4	Phase 2-	grey
5	+5V	white
6	GND	inner Shield
7	Sensor Sine	yellow
8	Sensor Cosine	green
9	Temp. Sensor	black
10	Shield	Outer Shield

Item	Description	Item-No.
MC01-P/m	Motor connector P (m)	0150-3020
MC01-P/f	Motor connector P (f)	0150-3021
MC01-P/m-as (assembled)	P/m-Connector assembled	0150-3056
MC01-P/f-as (assembled)	P/f-Connector assembled	0150-3144

D15-CONNECTOR

MC01-D15/f

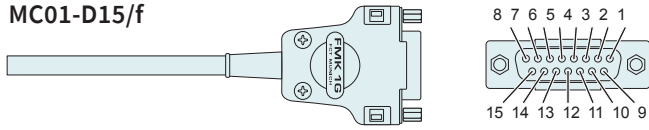

7 & 15	Phase 1+	red
3 & 10	Phase 1-	pink
6 & 14	Phase 2+	blue
2 & 9	Phase 2-	grey
11	+5V	white
12	GND	inner Shield
13	Sensor Sine	yellow
5	Sensor Cosine	green
4	Temp. Sensor	black
Housing	Shield	Outer shield

Item	Description	Item-No.
MC01-D15/f	Motor connector D15 (f)	0150-3136
MC01-D15/f-as (assembled)	D15/f-Connector assembled	0150-3073

E6k-CONNECTOR EX

MC01-E6k/f-EX

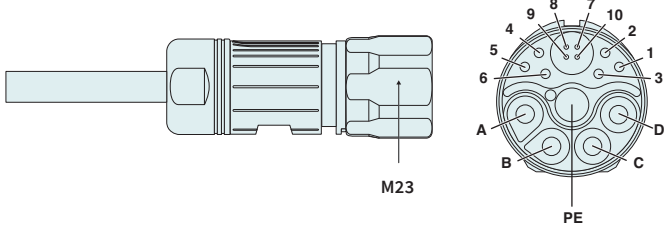

A	Phase 1+	red
B	Phase 1-	pink
C	Phase 2+	blue
D	Phase 2-	grey
PE	Protective Earth	green-yellow
1	+5V	white
2	GND	Inner shield (Signal Leads)
3	Sensor Sine	yellow
4	Sensor Cosine	green
5	Temp. Sensor	black
6	n.c.	-
7	Kty 1+	orange
8	Kty 1-	brown
9	Kty 2+	violett
10	Kty 2-	beige
Housing	Shield	Inner shield (Kty Leads) Outer shield

Item	Description	Item-No.
MC01-E6k/f-EX	Connector with hexagonal union nut	0150-3538
MC01-E6k/f-EX-as	E/f-Connector with hexagonal union nut assembled	0150-3641

REPLACED CABLES				
	Standard Motor Cable		Trailing Chain Cable	Robot Cable
Cable type	K05-04/05	K15-04/05	KS10-04/05	KR10-04/05
Item-No.	0150-1920	0150-1978	0150-1977	0150-1830
Wire cross-section Motor phases	0.5 mm ² (AWG20)	1.5 mm ² (AWG16)	1.0 mm ² (AWG18)	1.0 mm ² (AWG18)
Wire cross-section Sensor signal		0.14 mm ² (AWG26)	0.14 mm ² (AWG26)	0.14 mm ² (AWG26)
Wire cross-section Inner Filler		0.14 mm ² (AWG26)	0.14 mm ² (AWG26)	0.14 mm ² (AWG26)
Material Wire insulation	PUR	TPE-U	TPE-E	TPE-E
Material Cable sheath		PUR	PUR	PUR
Colour Cable sheath		Black	Black	Black
Cable cross section	8.2 mm (0.31 in)	11.2 mm (0.44 in)	10.8 mm (0.42 in)	10.9 mm (0.43 in)
Weight	83 kg/km	180 kg/km	139 kg/km	160 kg/km
Approvals	(-)	UL / CSA 300V E467697	UL / CSA 300V E172204	UL / CSA 300V E172204
AWM-Style		20233	20235	20233
Minimum bend- ing radius static	25 mm (1 in)	50 mm (2 in)	50 mm (2 in)	50 mm (2 in)
Minimum bend- ing radius moving	Not suitable for applications With moving motor cable		100 mm (4 in) No Torsion	100 mm (4 in) Max. Torsion: ±270° pro 0.5 m
Temperature range	-40°...+80°C		-40°...+80°C	
Oil resistance	very good acc. DIN VDE 0282 Part 10 + HD 22.10		very good acc. DIN VDE 0282 Part 10 + HD 22.10	
Chemical resistance	good to acids, alkalis, solvents, hydraulic fluids, etc.		good to acids, alkalis, solvents, hydraulic fluids, etc.	

GUIDELINES FOR THE LAYING OF CABLES IN CABLE CHAINS

The laying of cables in cable chains has to be done carefully. In general the following points have to be considered:

- It is recommended to lay the cables separately side by side. In case that cables with different diameters are laid on top of each other or side by side, we recommend the use of separators.
- The cables should be movable in the track. There must be at least 10% - 20% of the cable diameter as free space between the cables and the internal dimensions of the cable chain for safety reasons.
- Please observe that the cables pass the bend radius without being forced. In case of several cable layers, the cables need a corresponding clearance among each other in the bend so that relative movements of the cables among each other and in the chain are possible. In principle the cables must be able to move freely lengthwise at any time and there shall be no tensile force on the cable in the radius. After a short operating time it is recommended to control in regular intervals the position of the cable - particular with long travel paths (control must be executed in push and pull direction). Furthermore, it has to be paid attention to an efficient installation and aspects of wear.
- A torsion-free laying of the cables in the cable chain has to be observed (non-rotational). Therefore, the cables have to be unwound from reels before being installed. (Do not lift off the cables in loops). The ideal case is to take the cable directly from the drum. The cable imprint can't be used for a torsion free adjustment of the cable, as the imprint runs slightly helical around the cable due to production reasons.
- The weight arrangement in the cable chain or in the links has to be done symmetrically. Heavy cables have to be laid towards the outside of the cable chain and the smaller ones in the middle. After the rupture of the chain, all cables have to be exchanged due to excessive elongation.
- All cables have to be strain-relieved at the fixed point and at the driver, at least at the movable end of the chain. For use in long chains (sliding application), please contact our staff as there are no general regulations. It has to be observed with clamping that there is only large-surface pressure on the outer jacket. Careful clamping avoids any squeezing of the conductors and at the same time any displacement of the cable. It has to be avoided to move the cable up to the fixing point. The distance between the final point of the flexion to the fixing point should be as large as possible (10 - 20 x cable diameter are taken as relaxation zone).
- In general only cable chain cables should be used. The allowed bending radius has to be strictly observed. The information on the minimum bending radius for the cables are based on the application at normal temperatures (approx. 20 °C). Under circumstances other bending radii can be recommended. The choice of a bigger radius as the minimum radius will have a positive effect on the service life.

Area with horizontal dotted lines for notes.