

LINEAR MOTORS P01-48X240F-EX

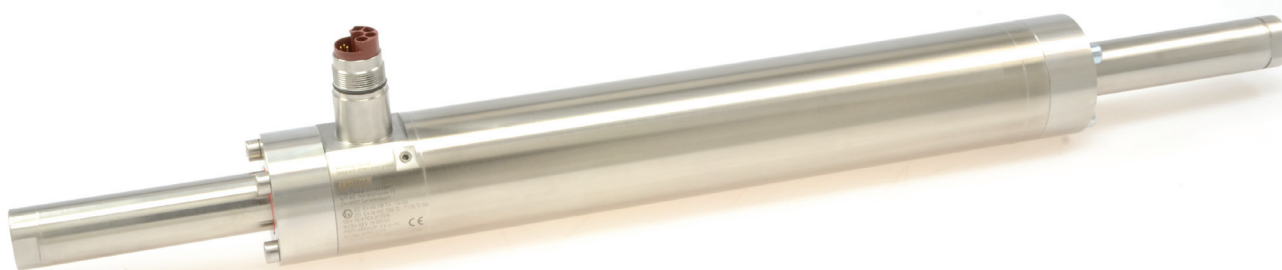

- ✓ For use in an explosive atmosphere consisting of gases, vapors, mist, or dust
- ✓ Welded connections
- ✓ Completely encapsulated
- ✓ Optional integrated water cooling

LINEAR MOTORS P01-48x240F-EX

Technical Data **695**

Motor Specifications

P01-48x240F/80x80-EX-E **698**

P01-48x240F/200x200-EX-E **699**

P01-48x240F/290x290-EX-E **700**

P01-48x240F/380x380-EX-E **701**

P01-48x240F/500x500-EX-E **702**

P01-48x240F/590x590-EX-E **703**

P01-48x240F/800x800-EX-E **704**

P01-48x240F/980x980-EX-E **705**

Accessories **706**

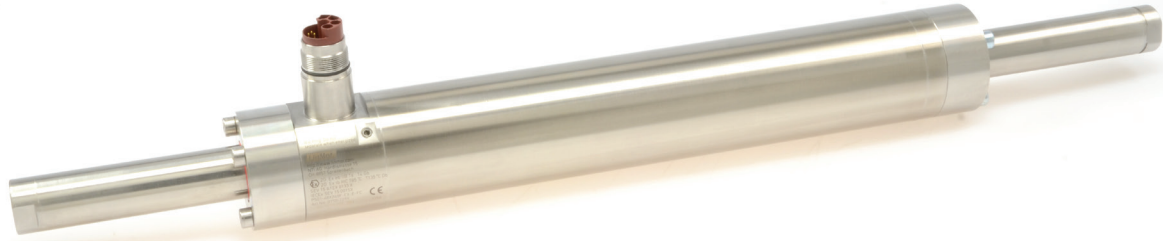

MOTOR FAMILY P01-48x240F-EX

Technical Data				
Stroke				
Max. Stroke	mm	(in)	980	(38.6)
Force				
Max. Force @ 48VDC	N	(lbf)	496	(111)
Max. Force @ 72VDC	N	(lbf)	496	(111)
Max. Cont. Force [Passive cooling / Fan / Fluid]	N	(lbf)	84 / - / 240	(19 / - / 53)
Max. Border Force relative	%		≤ 100	
Force Constant	N/A _{pk}	(lbf/A _{pk})	19.1	(4.29)
Velocity				
Max. Velocity @ 48VDC	m/s	(in/s)	2.2	(90.9)
Max. Velocity @ 72VDC	m/s	(in/s)	3.4	(139.9)
Position Detection				
Position Resolution	mm	(in)	0.007	(0.0003)
Repeatability	mm	(in)	±0.05	(±0.002)
Position Resolution with ES	mm	(in)	0.001	(0.00004)
Repeatability with ES	mm	(in)	±0.01	(±0.0004)
Linearity with ES	mm	(in)	±0.01	(±0.0004)
Electrical Data				
Max. Current @ 48VDC	A _{pk}		25.9	
Max. Current @ 72VDC	A _{pk}		25.9	
Max. Cont. Current [Passive cooling / Fan / Fluid]	A _{pk}		4.4 / - / 12	
Terminal Resistance 25 °C / 120 °C	Ohm		0.97 / 1.3	
Terminal Inductivity	mH		1.1	
Magnetic Period	mm	(in)	60	(2.35)
Thermal Data				
Max. Winding Temperature (Sensor)	°C		90	
Thermal Resistance [Passive cooling / Fan / Fluid]	°K/W		2 / - / 0.26	
Thermal Time Constant [Passive cooling / Fan / Fluid]	s		2100 / - / 260	
Mechanical Data				
Stator Diameter	mm	(in)	60	(2.4)
Stator Length	mm	(in)	395	(16)
Stator Mass	g	(lb)	4270	(9.4)
Slider Diameter	mm	(in)	27	(1.1)
Slider Length	mm	(in)	350 - 1400	(14 - 55)
Slider Mass	g	(lb)	1360 - 5910	(3 - 13)
IP Code			IP67	

CE 1258 Ex eb IIC T6... T4 Gb

CE 1258 Ex tb IIIC T85°C... T135°C Db

STATOR

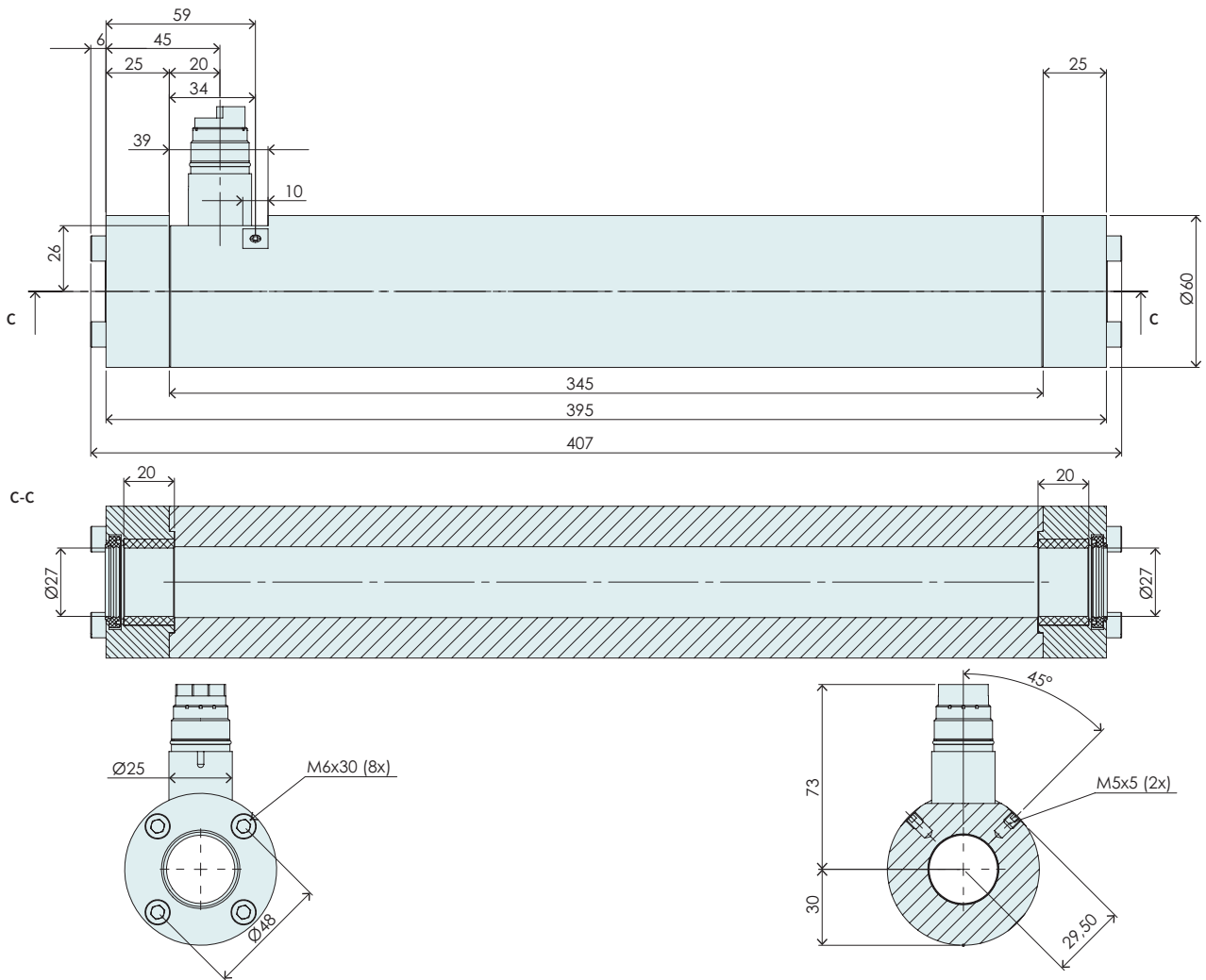

Item	Description	Item-No.
PS01-48x240F-EX-E	Stator EX, IP67	0150-2544
PS01-48x240F-EX-E-FC	Stator EX, IP67, FC	0150-1299

CONNECTOR

Motor Connector Wiring	PS01-48x240F-EX-E PS01-48x240F-EX-E-FC	Wire Color Motor Cable
	E6k-Connector	
Ph 1+	A	red
Ph 1-	B	pink
Ph 2+	C	blue
Ph 2-	D	grey
PE	Protective Earth	green-yellow
+5VDC	1	white
GND	2	Inner Shield
Sinus	3	yellow
Cosinus	4	green
Temp.	5	black
n. c.	6	-
Kty 1+	7	orange
Kty 1-	8	brown
Kty 2+	9	purple
Kty 2-	10	beige

E6k-Connector

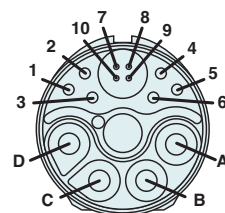

View: Motor connector, plug side

SLIDER

Slider High Clearance

Number of grooves determines the slider type (see chapter 2 / slider) and marks the front end.

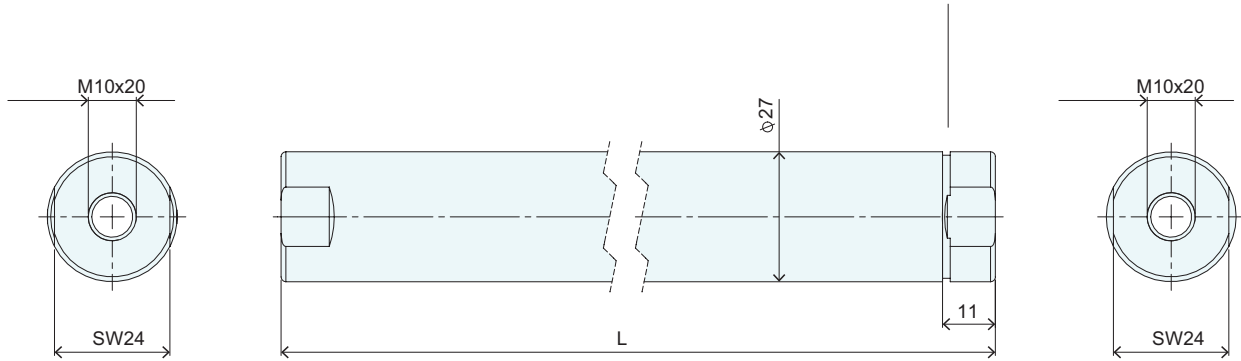

Slider High Clearance			
Item	Description	Max. Stroke [mm]	Item-No.
PL01-27x500/420	Slider 'High Clearance'	80	0150-1469
PL01-27x620/540	Slider 'High Clearance'	200	0150-1470
PL01-27x710/630	Slider 'High Clearance'	290	0150-1471
PL01-27x800/720	Slider 'High Clearance'	380	0150-1472
PL01-27x920/840	Slider 'High Clearance'	500	0150-1447
PL01-27x1010/930	Slider 'High Clearance'	590	0150-1473
PL01-27x1220/1140	Slider 'High Clearance'	800	0150-1587
PL01-27x1400/1320	Slider 'High Clearance'	980	0150-1588

P01-48x240F/80x80-EX-E

Max. Stroke: 80 mm
Peak Force: 496 N

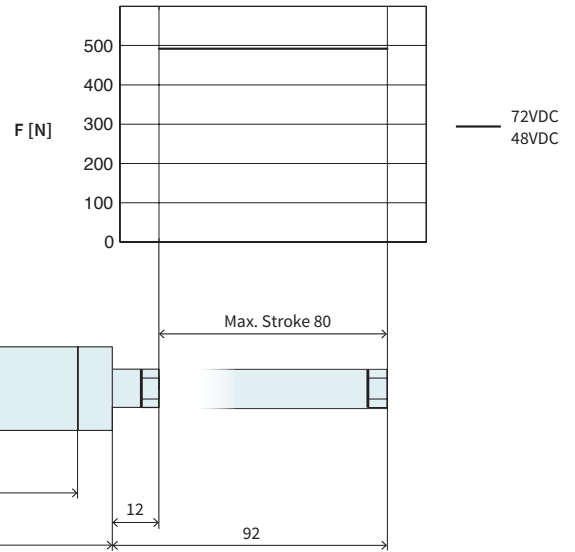

Dimensions in mm

Technical Data P01-48x240F/80x80-EX-E

Technical Data P01-48x240F/80x80-EX-E			
Stroke			
Max. Stroke	mm (in)	80	(3.14)
Force			
Max. Force @ 48VDC	N (lbf)	496	(111)
Max. Force @ 72VDC	N (lbf)	496	(111)
Max. Cont. Force [Passive cooling / Fan / Fluid]	N (lbf)	84 / - / 240	(19 / - / 53)
Max. Border Force relative	%	100	
Force Constant	N/A _{pk} (lbf/A _{pk})	19.1	(4.29)
Velocity			
Max. Velocity @ 48VDC	m/s (in/s)	2.2	(90.9)
Max. Velocity @ 72VDC	m/s (in/s)	3.4	(139.9)
Position Detection			
Repeatability	mm (in)	±0.05	(±0.002)
Linearity	%	± 1.05	
Electrical Data			
Max. Current @ 48VDC	A _{pk}	25.9	
Max. Current @ 72VDC	A _{pk}	25.9	
Max. Cont. Current [Passive cooling / Fan / Fluid]	A _{pk}	4.4 / - / 12	
Thermal Data			
Max. Winding Temperature (Sensor)	°C	90	
Thermal Resistance [Passive cooling / Fan / Fluid]	°K/W	2 / - / 0.26	
Thermal Time Constant [Passive cooling / Fan / Fluid]	s	2100 / - / 260	
Mechanical Data			
Slider Length	mm (in)	500	(20)
Slider Mass	g (lb)	2010	(4.42)

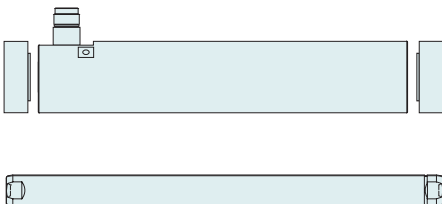

Item	Description	Item-No.
PS01-48x240F-EX-E	Stator EX, IP67	0150-2544
PS01-48x240F-EX-E-FC	Stator EX, IP67, FC	0150-1299
PB01-48x25-P-SSC*	Bearing for PS01-48x240-SSC (Stainless)	0150-3281
PL01-27x500/420	Slider 'High Clearance'	0150-1469

* 2 Bearing kits must be ordered separately.

P01-48x240F/200x200-EX-E

Max. Stroke: 200 mm
Peak Force: 496 N

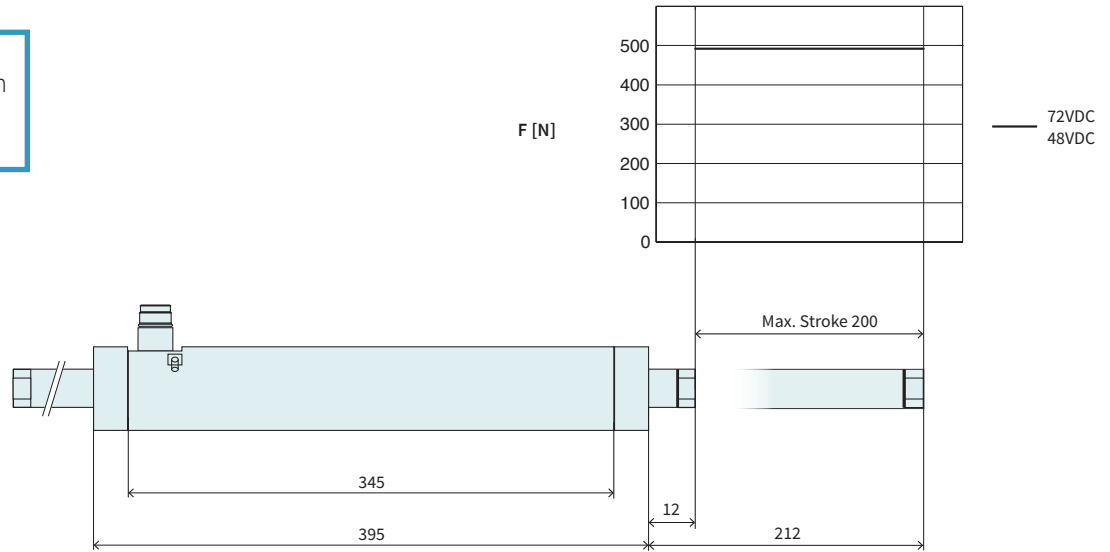

Dimensions in mm

Technical Data P01-48x240F/200x200-EX-E				
Stroke				
Max. Stroke	mm	(in)	200	(7.86)
Force				
Max. Force @ 48VDC	N	(lbf)	496	(111)
Max. Force @ 72VDC	N	(lbf)	496	(111)
Max. Cont. Force [Passive cooling / Fan / Fluid]	N	(lbf)	84 / - / 240	(19 / - / 53)
Max. Border Force relative	%		100	
Force Constant	N/A _{pk}	(lbf/A _{pk})	19.1	(4.29)
Velocity				
Max. Velocity @ 48VDC	m/s	(in/s)	2.2	(90.9)
Max. Velocity @ 72VDC	m/s	(in/s)	3.4	(139.9)
Position Detection				
Repeatability	mm	(in)	±0.05	(±0.002)
Linearity	%		± 0.5	
Electrical Data				
Max. Current @ 48VDC	A _{pk}		25.9	
Max. Current @ 72VDC	A _{pk}		25.9	
Max. Cont. Current [Passive cooling / Fan / Fluid]	A _{pk}		4.4 / - / 12	
Thermal Data				
Max. Winding Temperature (Sensor)	°C		90	
Thermal Resistance [Passive cooling / Fan / Fluid]	°K/W		2 / - / 0.26	
Thermal Time Constant [Passive cooling / Fan / Fluid]	s		2100 / - / 260	
Mechanical Data				
Slider Length	mm	(in)	620	(24)
Slider Mass	g	(lb)	2530	(5.57)



Item	Description	Item-No.
PS01-48x240F-EX-E	Stator EX, IP67	0150-2544
PS01-48x240F-EX-E-FC	Stator EX, IP67, FC	0150-1299
PB01-48x25-P-SSC*	Bearing for PS01-48x240-SSC (Stainless)	0150-3281
PL01-27x620/540	Slider 'High Clearance'	0150-1470

* 2 Bearing kits must be ordered separately.

P01-48x240F/290x290-EX-E

Max. Stroke: 290 mm
Peak Force: 496 N

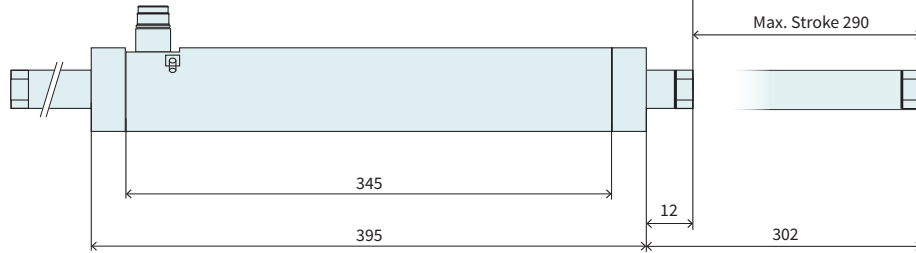
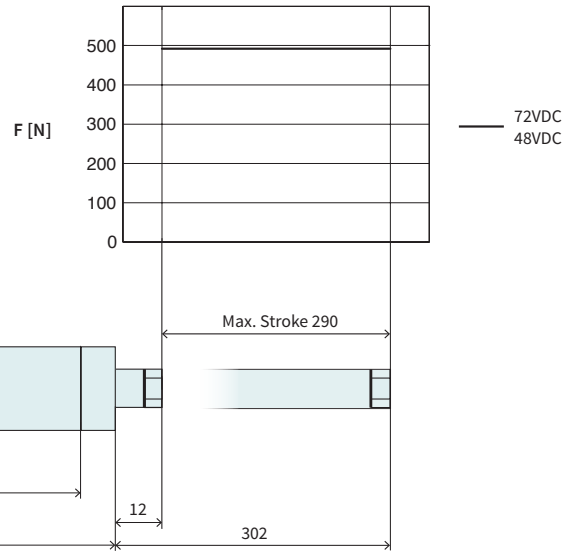

Dimensions in mm

Technical Data P01-48x240F/290x290-EX-E			
Stroke			
Max. Stroke	mm (in)	290	(11.4)
Force			
Max. Force @ 48VDC	N (lbf)	496	(111)
Max. Force @ 72VDC	N (lbf)	496	(111)
Max. Cont. Force [Passive cooling / Fan / Fluid]	N (lbf)	84 / - / 240	(19 / - / 53)
Max. Border Force relative	%	100	
Force Constant	N/A _{pk} (lbf/A _{pk})	19.1	(4.29)
Velocity			
Max. Velocity @ 48VDC	m/s (in/s)	2.2	(90.9)
Max. Velocity @ 72VDC	m/s (in/s)	3.4	(139.9)
Position Detection			
Repeatability	mm (in)	±0.05	(±0.002)
Linearity	%	± 0.35	
Electrical Data			
Max. Current @ 48VDC	A _{pk}	25.9	
Max. Current @ 72VDC	A _{pk}	25.9	
Max. Cont. Current [Passive cooling / Fan / Fluid]	A _{pk}	4.4 / - / 12	
Thermal Data			
Max. Winding Temperature (Sensor)	°C	90	
Thermal Resistance [Passive cooling / Fan / Fluid]	°K/W	2 / - / 0.26	
Thermal Time Constant [Passive cooling / Fan / Fluid]	s	2100 / - / 260	
Mechanical Data			
Slider Length	mm (in)	710	(28)
Slider Mass	g (lb)	2920	(6.42)



Item	Description	Item-No.
PS01-48x240F-EX-E	Stator EX, IP67	0150-2544
PS01-48x240F-EX-E-FC	Stator EX, IP67, FC	0150-1299
PB01-48x25-P-SSC*	Bearing for PS01-48x240-SSC (Stainless)	0150-3281
PL01-27x710/630	Slider 'High Clearance'	0150-1471

* 2 Bearing kits must be ordered separately.

P01-48x240F/380x380-EX-E

Max. Stroke: 380 mm
Peak Force: 496 N

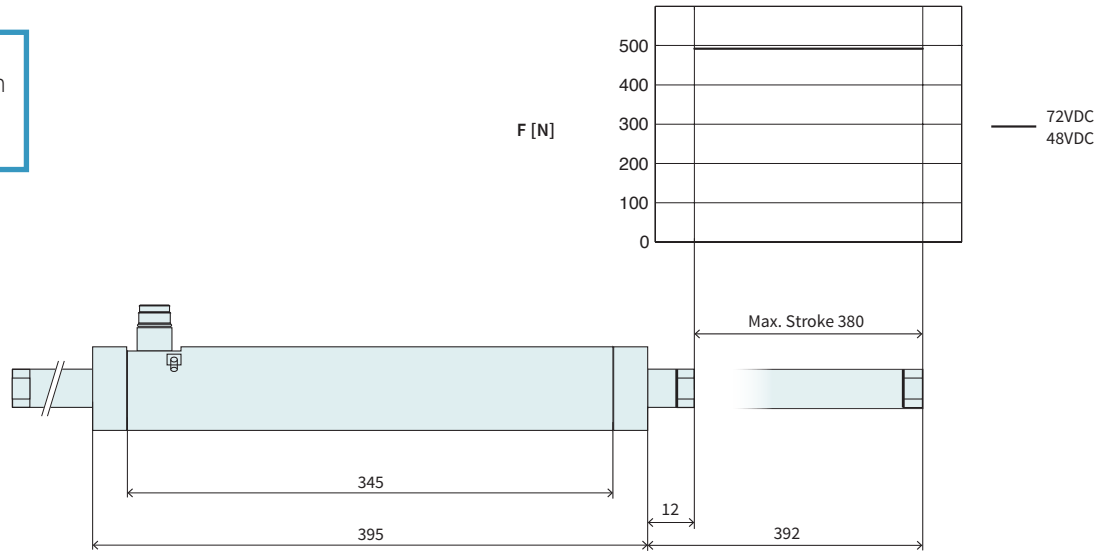

Dimensions in mm

Technical Data P01-48x240F/380x380-EX-E				
Stroke				
Max. Stroke	mm	(in)	380	(14.99)
Force				
Max. Force @ 48VDC	N	(lbf)	496	(111)
Max. Force @ 72VDC	N	(lbf)	496	(111)
Max. Cont. Force [Passive cooling / Fan / Fluid]	N	(lbf)	84 / - / 240	(19 / - / 53)
Max. Border Force relative	%		100	
Force Constant	N/A _{pk}	(lbf/A _{pk})	19.1	(4.29)
Velocity				
Max. Velocity @ 48VDC	m/s	(in/s)	2.2	(90.9)
Max. Velocity @ 72VDC	m/s	(in/s)	3.4	(139.9)
Position Detection				
Repeatability	mm	(in)	±0.05	(±0.002)
Linearity	%		± 0.3	
Electrical Data				
Max. Current @ 48VDC	A _{pk}		25.9	
Max. Current @ 72VDC	A _{pk}		25.9	
Max. Cont. Current [Passive cooling / Fan / Fluid]	A _{pk}		4.4 / - / 12	
Thermal Data				
Max. Winding Temperature (Sensor)	°C		90	
Thermal Resistance [Passive cooling / Fan / Fluid]	°K/W		2 / - / 0.26	
Thermal Time Constant [Passive cooling / Fan / Fluid]	s		2100 / - / 260	
Mechanical Data				
Slider Length	mm	(in)	800	(31)
Slider Mass	g	(lb)	3310	(7.28)

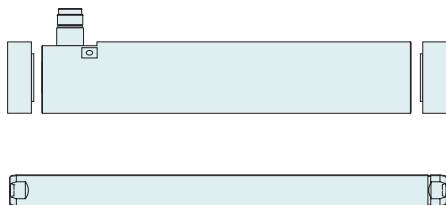

Item	Description	Item-No.
PS01-48x240F-EX-E	Stator EX, IP67	0150-2544
PS01-48x240F-EX-E-FC	Stator EX, IP67, FC	0150-1299
PB01-48x25-P-SSC*	Bearing for PS01-48x240-SSC (Stainless)	0150-3281
PL01-27x800/720	Slider 'High Clearance'	0150-1472

* 2 Bearing kits must be ordered separately.

P01-48x240F/500x500-EX-E

Max. Stroke: 500 mm
Peak Force: 496 N

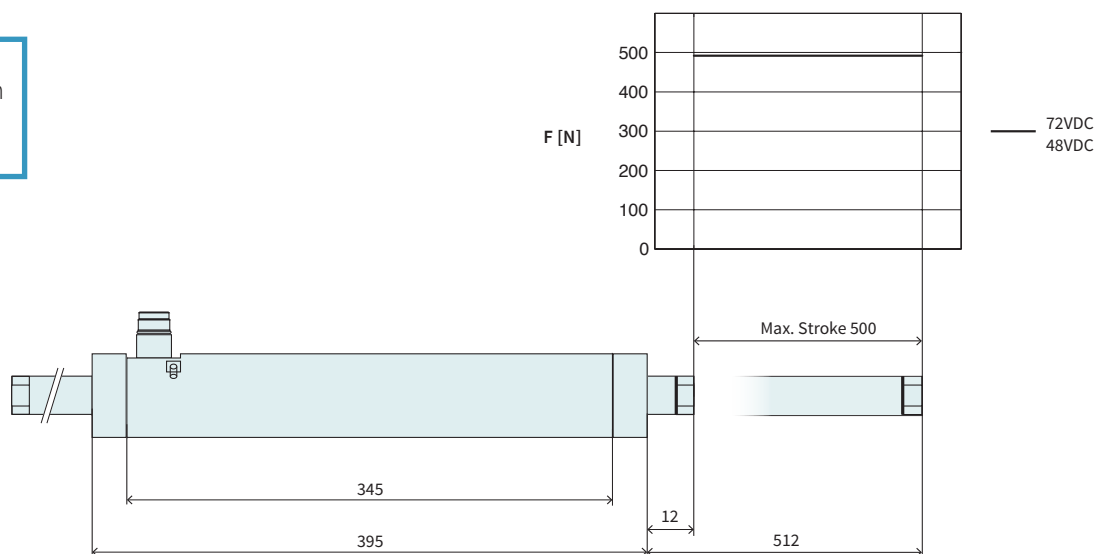

Dimensions in mm

Technical Data P01-48x240F/500x500-EX-E			
Stroke			
Max. Stroke	mm (in)	500	(19.69)
Force			
Max. Force @ 48VDC	N (lbf)	496	(111)
Max. Force @ 72VDC	N (lbf)	496	(111)
Max. Cont. Force [Passive cooling / Fan / Fluid]	N (lbf)	84 / - / 240	(19 / - / 53)
Max. Border Force relative	%	100	
Force Constant	N/A _{pk} (lbf/A _{pk})	19.1	(4.29)
Velocity			
Max. Velocity @ 48VDC	m/s (in/s)	2.2	(90.9)
Max. Velocity @ 72VDC	m/s (in/s)	3.4	(139.9)
Position Detection			
Repeatability	mm (in)	±0.05	(±0.002)
Linearity	%	± 0.25	
Electrical Data			
Max. Current @ 48VDC	A _{pk}	25.9	
Max. Current @ 72VDC	A _{pk}	25.9	
Max. Cont. Current [Passive cooling / Fan / Fluid]	A _{pk}	4.4 / - / 12	
Thermal Data			
Max. Winding Temperature (Sensor)	°C	90	
Thermal Resistance [Passive cooling / Fan / Fluid]	°K/W	2 / - / 0.26	
Thermal Time Constant [Passive cooling / Fan / Fluid]	s	2100 / - / 260	
Mechanical Data			
Slider Length	mm (in)	920	(36)
Slider Mass	g (lb)	3830	(8.43)



Item	Description	Item-No.
PS01-48x240F-EX-E	Stator EX, IP67	0150-2544
PS01-48x240F-EX-E-FC	Stator EX, IP67, FC	0150-1299
PB01-48x25-P-SSC*	Bearing for PS01-48x240-SSC (Stainless)	0150-3281
PL01-27x920/840	Slider 'High Clearance'	0150-1447

* 2 Bearing kits must be ordered separately.

P01-48x240F/590x590-EX-E

Max. Stroke: 590 mm
Peak Force: 496 N

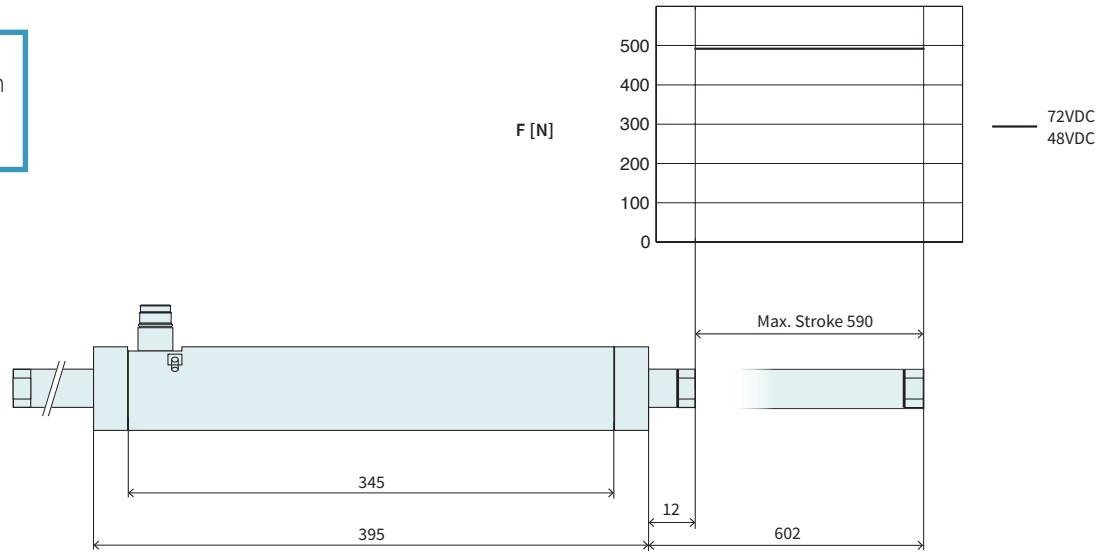

Dimensions in mm

Technical Data P01-48x240F/590x590-EX-E				
Stroke				
Max. Stroke	mm	(in)	590	(23.19)
Force				
Max. Force @ 48VDC	N	(lbf)	496	(111)
Max. Force @ 72VDC	N	(lbf)	496	(111)
Max. Cont. Force [Passive cooling / Fan / Fluid]	N	(lbf)	84 / - / 240	(19 / - / 53)
Max. Border Force relative			%	
			100	
Force Constant	N/A _{pk}	(lbf/A _{pk})	19.1	(4.29)
Velocity				
Max. Velocity @ 48VDC	m/s	(in/s)	2.2	(90.9)
Max. Velocity @ 72VDC	m/s	(in/s)	3.4	(139.9)
Position Detection				
Repeatability	mm	(in)	±0.05	(±0.002)
Linearity			%	
			± 0.25	
Electrical Data				
Max. Current @ 48VDC			A _{pk}	
			25.9	
Max. Current @ 72VDC			A _{pk}	
			25.9	
Max. Cont. Current [Passive cooling / Fan / Fluid]			A _{pk}	
			4.4 / - / 12	
Thermal Data				
Max. Winding Temperature (Sensor)			°C	
			90	
Thermal Resistance [Passive cooling / Fan / Fluid]			°K/W	
			2 / - / 0.26	
Thermal Time Constant [Passive cooling / Fan / Fluid]			s	
			2100 / - / 260	
Mechanical Data				
Slider Length	mm	(in)	1010	(40)
Slider Mass	g	(lb)	4220	(9.28)



Item	Description	Item-No.
PS01-48x240F-EX-E	Stator EX, IP67	0150-2544
PS01-48x240F-EX-E-FC	Stator EX, IP67, FC	0150-1299
PB01-48x25-P-SSC*	Bearing for PS01-48x240-SSC (Stainless)	0150-3281
PL01-27x1010/930	Slider 'High Clearance'	0150-1473

* 2 Bearing kits must be ordered separately.

P01-48x240F/800x800-EX-E

Max. Stroke: 800 mm
Peak Force: 496 N

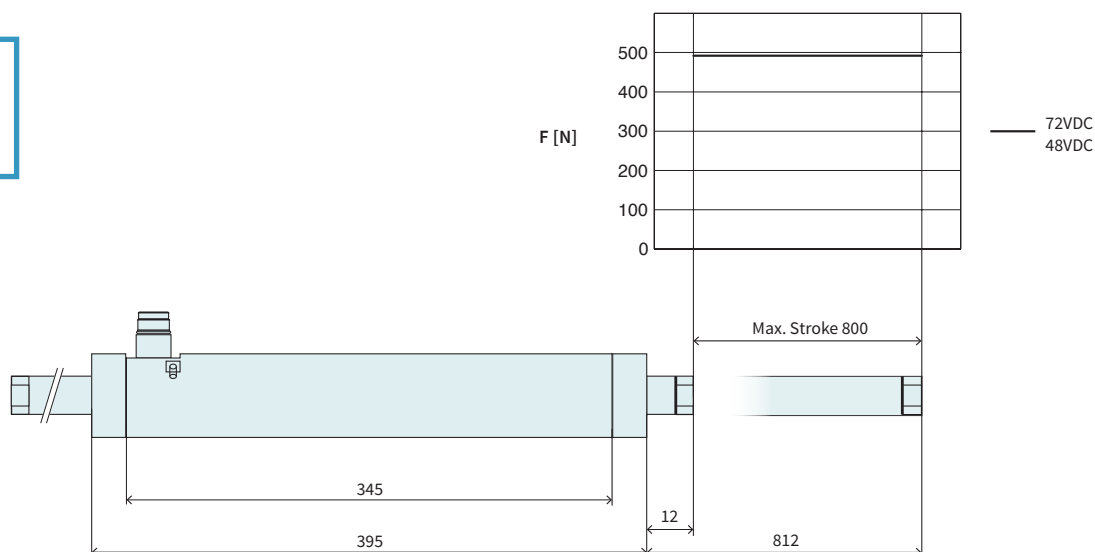

Dimensions in mm

Technical Data P01-48x240F/800x800-EX-E

Stroke			
Max. Stroke	mm (in)	800 (31.49)	
Force			
Max. Force @ 48VDC	N (lbf)	496 (111)	
Max. Force @ 72VDC	N (lbf)	496 (111)	
Max. Cont. Force [Passive cooling / Fan / Fluid]	N (lbf)	84 / - / 240 (19 / - / 53)	
Max. Border Force relative	%	100	
Force Constant	N/A _{pk} (lbf/A _{pk})	19.1 (4.29)	
Velocity			
Max. Velocity @ 48VDC	m/s (in/s)	2.2 (90.9)	
Max. Velocity @ 72VDC	m/s (in/s)	3.4 (139.9)	
Position Detection			
Repeatability	mm (in)	±0.05 (±0.002)	
Linearity	%	± 0.2	
Electrical Data			
Max. Current @ 48VDC	A _{pk}	25.9	
Max. Current @ 72VDC	A _{pk}	25.9	
Max. Cont. Current [Passive cooling / Fan / Fluid]	A _{pk}	4.4 / - / 12	
Thermal Data			
Max. Winding Temperature (Sensor)	°C	90	
Thermal Resistance [Passive cooling / Fan / Fluid]	°K/W	2 / - / 0.26	
Thermal Time Constant [Passive cooling / Fan / Fluid]	s	2100 / - / 260	
Mechanical Data			
Slider Length	mm (in)	1220 (48)	
Slider Mass	g (lb)	5130 (11.29)	

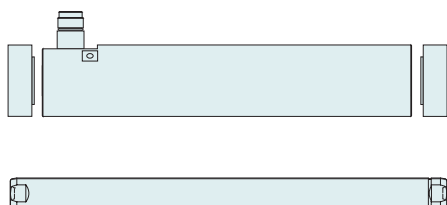

Item	Description	Item-No.
PS01-48x240F-EX-E	Stator EX, IP67	0150-2544
PS01-48x240F-EX-E-FC	Stator EX, IP67, FC	0150-1299
PB01-48x25-P-SSC*	Bearing for PS01-48x240-SSC (Stainless)	0150-3281
PL01-27x1220/1140	Slider 'High Clearance'	0150-1587

* 2 Bearing kits must be ordered separately.

P01-48x240F/980x980-EX-E

Max. Stroke: 980 mm
Peak Force: 496 N

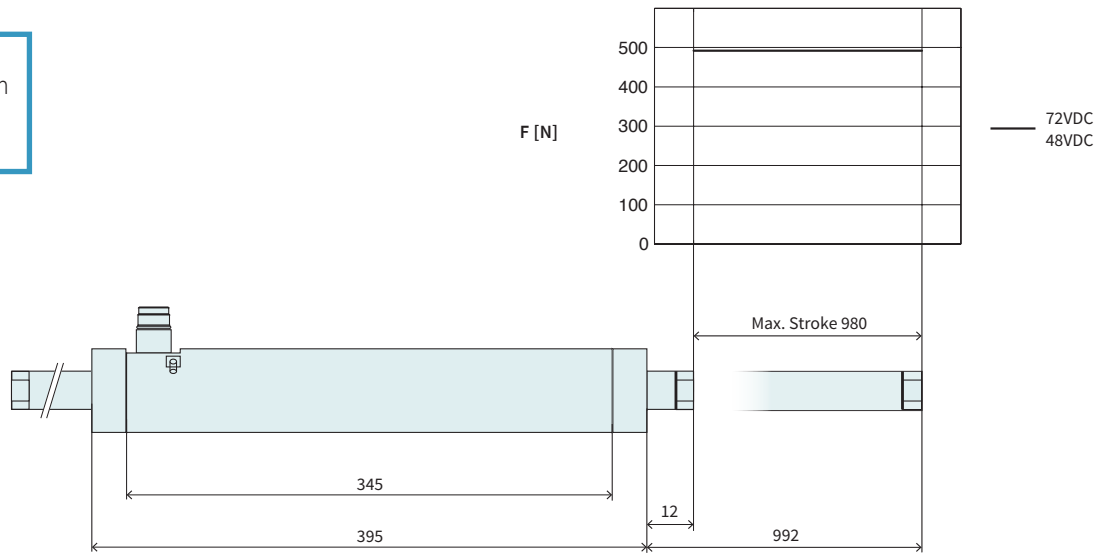

Dimensions in mm

Technical Data P01-48x240F/980x980-EX-E			
Stroke			
Max. Stroke	mm (in)		980 (38.6)
Force			
Max. Force @ 48VDC	N (lbf)		496 (111)
Max. Force @ 72VDC	N (lbf)		496 (111)
Max. Cont. Force [Passive cooling / Fan / Fluid]	N (lbf)		84 / - / 240 (19 / - / 53)
Max. Border Force relative	%		100
Force Constant	N/A _{pk} (lbf/A _{pk})		19.1 (4.29)
Velocity			
Max. Velocity @ 48VDC	m/s (in/s)		2.2 (90.9)
Max. Velocity @ 72VDC	m/s (in/s)		3.4 (139.9)
Position Detection			
Repeatability	mm (in)		±0.05 (±0.002)
Linearity	%		± 0.2
Electrical Data			
Max. Current @ 48VDC	A _{pk}		25.9
Max. Current @ 72VDC	A _{pk}		25.9
Max. Cont. Current [Passive cooling / Fan / Fluid]	A _{pk}		4.4 / - / 12
Thermal Data			
Max. Winding Temperature (Sensor)	°C		90
Thermal Resistance [Passive cooling / Fan / Fluid]	*K/W		2 / - / 0.26
Thermal Time Constant [Passive cooling / Fan / Fluid]	s		2100 / - / 260
Mechanical Data			
Slider Length	mm (in)		1400 (55)
Slider Mass	g (lb)		5910 (13)



Item	Description	Item-No.
PS01-48x240F-EX-E	Stator EX, IP67	0150-2544
PS01-48x240F-EX-E-FC	Stator EX, IP67, FC	0150-1299
PB01-48x25-P-SSC*	Bearing for PS01-48x240-SSC (Stainless)	0150-3281
PL01-27x1400/1320	Slider 'High Clearance'	0150-1588

* 2 Bearing kits must be ordered separately.

Motor Cable

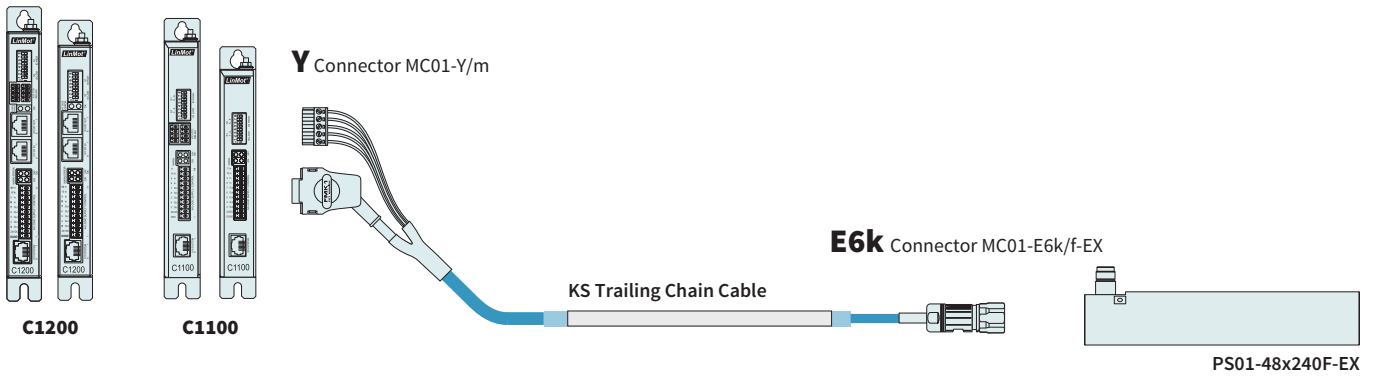

ORDERING INFORMATION

TRAILING CHAIN CABLE

Item	Description	Item-No.
KS10-EX-Y-Fe/E6k-	Trailing Chain Cable KS10-EX-Y-Fe/E6k-, Custom length	0150-3642

CONNECTOR & CABLE (INDIVIDUAL)

Item	Description	Item-No.
MC01-Y-Fe/m	Motor Connector Y-Fe/m	0150-3289
MC01-E6k/f-EX	Connector with hexagonal union nut	0150-3538
KS10-05/05/04-EX	Motor cable for EX applications per m	0150-9010

SLIDER MOUNTING



Item	Description	Item-No.
PLF01-28-SS	Fixed Bearing Set for 27/28 mm sliders, stainless steel	0150-3297
PLL01-27	Floating Bearing for 27 mm sliders	0150-3294

FIND MORE PRODUCT DETAILS IN THE CHAPTER „ACCESSORIES“.

BEARING KIT

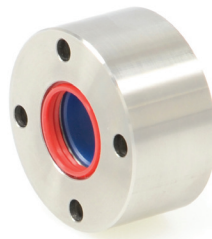

Item	Description	Item-No.
PB01-48x25-P-SSC	Bearing for PS01-48x240-SSC (Stainless)	0150-3281

FIND MORE PRODUCT DETAILS IN THE CHAPTER „ACCESSORIES“.

Area containing horizontal dotted lines for notes.