

LINEAR MOTORS P10-70X320U

4



- ✓ 3 x 400VAC technology
- ✓ Peak forces up to 2180 N
- ✓ LinMot encoder or 3rd party drive encoder
BiSS-C, SinCos, AB incremental / Pt 1000, KTY, PTC
- ✓ Extremely high dynamic
- ✓ Separate connector for sensor and power cable
- ✓ Can also be controlled by standard third-party servo drives

LINEAR MOTORS P10-70X320U

- / TECHNICAL DATA / 590**
- / MOTOR SPECIFICATIONS / 604**
 - P10-70x320U/30-BL-QJ..... 604
 - P10-70x320U/130-BL-QJ..... 605
 - P10-70x320U/230-BL-QJ..... 606
 - P10-70x320U/330-BL-QJ..... 607
 - P10-70x320U/430-BL-QJ..... 608
 - P10-70x320U/530-BL-QJ..... 609
 - P10-70x320U/730-BL-QJ..... 610
 - P10-70x320U/930-BL-QJ..... 611
 - P10-70x320U/1130-BL-QJ 612
 - P10-70x320U/1330-BL-QJ 613
 - P10-70x320U/1530-BL-QJ 614
- / LINEAR GUIDES / 615**
- / ACCESSORIES / 617**



MOTOR FAMILY P10-70x320U

Technical Data

Stroke			
Max. Stroke (ES)	mm (in)		1530 (60.2)
Force			
Max. Force ¹ @ 1x230VAC	N (lbf)		2170 (487)
Max. Force ¹ @ 3x400VAC	N (lbf)		2180 (489)
Max. Cont. Force [Passive cooling / Fan / Fluid]	N (lbf)		260 / 400 / 700 (58 / 89 / 160)
Max. Border Force relative	%		100
Force Constant 1	N/A _{pk} (lbf/A _{pk})		64 (14.4)
Force Constant 2	N/A _{rms} (lbf/A _{rms})		90.5 (20.3)
Velocity			
Max. Velocity @ 1x230VAC	m/s (in/s)		2.8 (109.9)
Max. Velocity @ 3x400VAC	m/s (in/s)		4.9 (199.9)
Position Detection			
Position Resolution	mm (in)		0.005 (0.0002)
Repeatability	mm (in)		±0.05 (±0.002)
Position Resolution with ES	mm (in)		0.001 (0.00004)
Repeatability with ES	mm (in)		±0.01 (±0.0004)
Linearity with ES	mm (in)		±0.01 (±0.0004)
Electrical Data			
Max. Current ² @ 1x230VAC	A _{pk} / A _{rms}		33.7 / 23.8
Max. Current ² @ 3x400VAC	A _{pk} / A _{rms}		33.9 / 23.9
Max. Cont. Current 1 [Passive cooling / Fan / Fluid]	A _{pk}		4.1 / 6.2 / 11
Max. Cont. Current 2 [Passive cooling / Fan / Fluid]	A _{rms}		2.9 / 4.4 / 7.7
Back EMF Constant	V _{pk} / (m/s) V _{pk} / (in/s)		73.9 (1.88)
Terminal Resistance 25 °C / 120 °C	Ohm		5.5 / 7.5
Terminal Inductivity	mH		10
Magnetic Period	mm (in)		40 (1.57)
Thermal Data			
Max. Winding Temperature (Sensor)	°C		90
Thermal Resistance [Passive cooling / Fan / Fluid]	°K/W		0.65 / 0.28 / 0.09
Thermal Time Constant [Passive cooling / Fan / Fluid]	s		2100 / 500 / 110
Mechanical Data			
Stator Diameter	mm (in)		70 (2.8)
Stator Length	mm (in)		420 (17)
Stator Mass	g (lb)		6900 (15.18)
Slider Diameter	mm (in)		28 (1.1)
Slider Length	mm (in)		490 - 1990 (19 - 78)
Slider Mass	g (lb)		2300 - 9350 (5.06 - 20.57)
IP Code			IP 65
Certification			
UL	File-No.		E354430

1) Real time calculation of motor winding temperature is required (including monitoring).
 If temperature monitoring is only based on temperature sensor signal (missing thermal model calculation), 60 % of the peak value has to be taken instead.
 2) ES = External Sensor

STATOR



Item	Description	Item-No.	Comment
PS10-70x320U-BL-QJ	Stator 3x400VAC, LinMot Encoder	0150-1284	For use with LinMot Drives
PS10-70x320U-BL-QJ-D04	Stator 3x400VAC, Sin/Cos Encoder 1Vpp, Pt1000 dual	0150-4263	For use with 3rd Party Drives
PS10-70x320U-BL-QJ-D05	Stator 3x400VAC, Sin/Cos Encoder 1Vpp, PTC dual	0150-4608	For use with 3rd Party Drives
PS10-70x320U-BL-QJ-D08	Stator 3x400VAC, Sin/Cos Encoder 1Vpp, KTY dual	0150-4513	For use with 3rd Party Drives
PS10-70x320U-BL-QJ-D24	Stator 3x400VAC, A/B Encoder 1µm, Pt1000 dual	0150-4133	For use with 3rd Party Drives
PS10-70x320U-BL-QJ-D24S	Stator 3x400VAC, A/B Encoder 5µm, Pt1000 dual	0150-4598	For use with 3rd Party Drives
PS10-70x320U-BL-QJ-D25	Stator 3x400VAC, A/B Encoder 1µm, PTC dual	0150-5763	For use with 3rd Party Drives
PS10-70x320U-BL-QJ-D25S	Stator 3x400VAC, A/B Encoder 5µm, PTC dual	0150-4603	For use with 3rd Party Drives
PS10-70x320U-BL-QJ-D26	Stator 3x400VAC, A/B Encoder 1µm, PTC single ended	0150-4517	For use with 3rd Party Drives
PS10-70x320U-BL-QJ-D34	Stator 3x400VAC, BiSS-C, Pt1000 dual	0150-4873	For use with 3rd Party Drives

AVAILABLE INTERFACES FOR 3RD PARTY DRIVES

TEMPERATURE FEEDBACK		POSITION FEEDBACK			
		SinCos, 1Vpp	A/B 1µm	A/B 5µm	BiSS-C
Pt1000, dual*	Dx4	D0x	D2x	D2xS	D3x
PTC, dual*	Dx5	D05	D25	D25S	
PTC single ended	Dx6		D26		
KTY, dual*	Dx8	D08			

* Feedback available on encoder and power connectors.

CONNECTOR PS10-70x320U-BL-QJ (INTERFACE FOR LINMOT DRIVES)

4

Motor Connector Wiring		Connector Encoder J	Wire Color Cable KSS05-02/08
+5VDC*	Supply	1	red
GND	Supply	2	black
Sense +5V*	Supply Sense	3	white
Sense GND*	Supply Sense	4	brown
Mot. Link C+	Communication	5	pink
Mot. Link C-	Communication	6	grey
Sin+	Encoder	7	yellow
Sin-	Encoder	8	orange
Cos+	Encoder	9	green
Cos-	Encoder	10	blue
n. c.	n. c.	11	n. c.
n. c.	n. c.	12	n. c.
n. c.	n. c.	13	n. c.
n. c.	n. c.	14	n. c.
n. c.	n. c.	15	n. c.
n. c.	n. c.	16	n. c.
n. c.	n. c.	17	n. c.

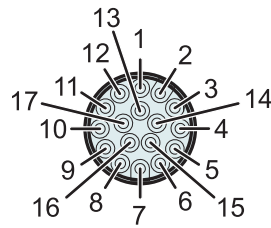

Connector Encoder J

View: Motor connector, plug side

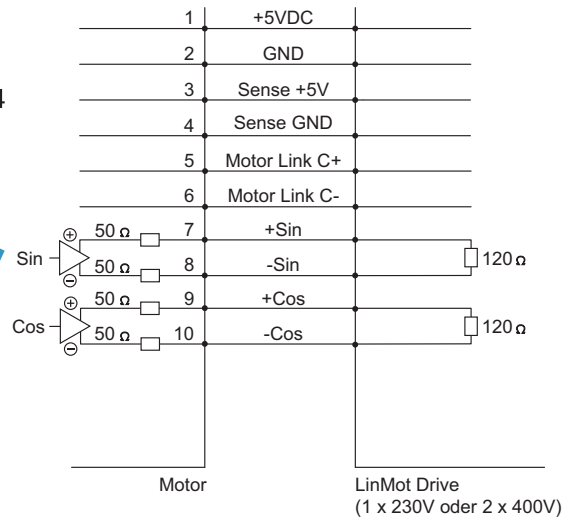

* The supply voltage at 5V sense supply is approx. 6V. Newer motors are provided with a modified power supply, that does not require sense lines any more. In that case, a supply voltage of 6...9V is permitted.

Motor Connector Wiring	Connector Power Q	Wire Color Cable KPS15-04
Phase U	1	red
PE	2	yellow-green
Phase W	3	black (previously: green)
Phase V	4	blue
n. c.	A	n. c.
n. c.	B	n. c.
n. c.	C	n. c.
n. c.	D	n. c.

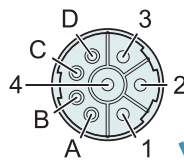

Connector Power Q

View: Motor connector, plug side

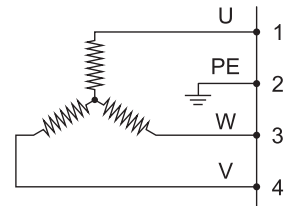

SIN/COS-POSITIONS-FEEDBACK (D0X-INTERFACE FOR 3RD PARTY DRIVES)

The linear motors of the P10-70 series have a contactless, integrated position feedback, which means that an external encoder is not required. The integrated position sensor technology of the motors with D0x interface provides a differential standard 1Vpp sin/cos signal with a 40mm period. The phase position of the sensor signals and the phase currents (with constant force in positive direction) is shown on the right side of the diagram. (The SIN encoder signal is in phase with the current characteristic of phase U).

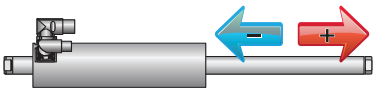

The arrows show the direction of movement of the slider. The stator remains in its position.

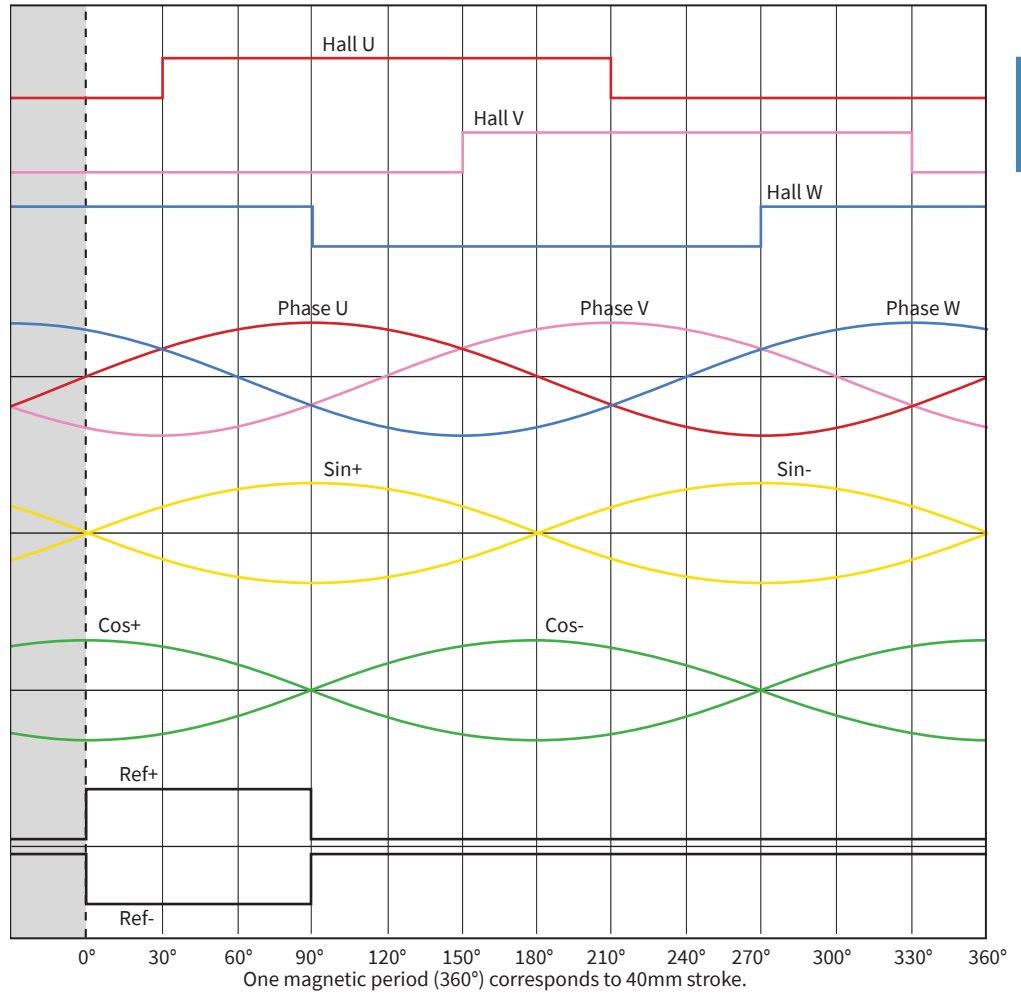

Sin / Cos		P10-70x...-D0x
Output signal period	mm	40
Signal amplitude ¹	V _{pp}	1
Termination ¹	Ohm	120
Supply voltage	Vdc	3...13 (w or w/o sense)
Power consumption	mW	< 1000
		(I < 150mA @ 5VDC, I < 80mA @ 12 VDC) ²

1) Applicable for Sin+/Sin-, Cos+/Cos- and Ref+/Ref- signals. Hall U/V/W are open collector signals.
 2) Power efficiency of the motor electronics varies with supply voltage

CONNECTOR PS10-70X320U-BL-QJ-D04/05/08 (SIN/COS-INTERFACE FOR 3RD PARTY DRIVES)

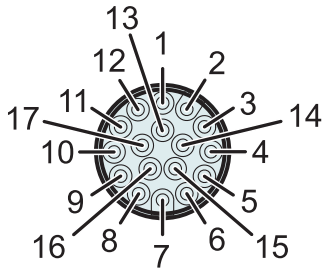

3 ... 13VDC
 (I_{max} < 150mA @ 5VDC)
 (I_{max} < 80mA @ 12VDC)

Connector Encoder J

View: Motor connector, plug side

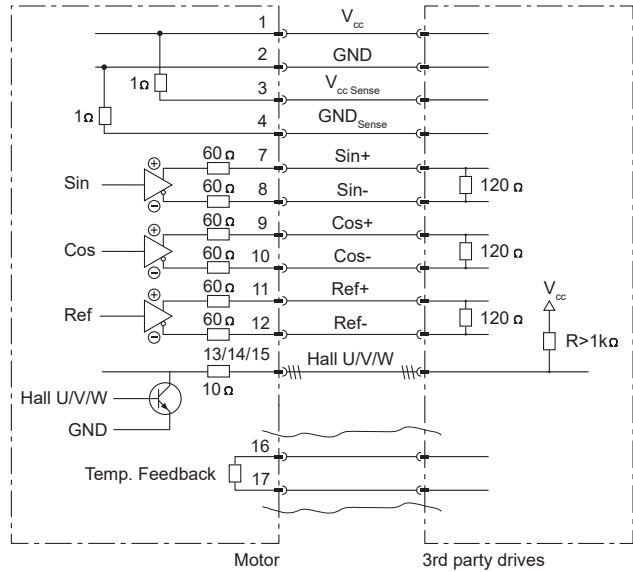

PS10-70X320U-BL-QJ-D04

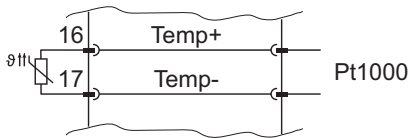

PS10-70X320U-BL-QJ-D05

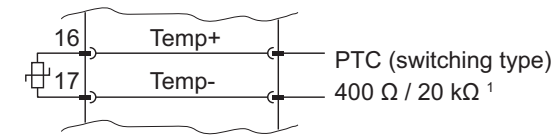

1) ≤ 400 Ω = no error, ≥ 20 kΩ = error

PS10-70X320U-BL-QJ-D08

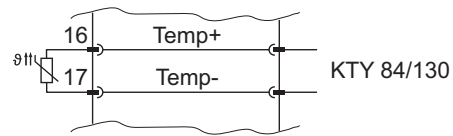

Sin/Cos-Interface: Encoder Connector Wiring

PS10-70x320U-BL-QJ-D04	PS10-70x320U-BL-QJ-D05	PS10-70x320U-BL-QJ-D08	Connector Encoder J	Wire Color Motor Cable KSS05-02/06	Wire Color Motor Cable KSS05-02/13
	3 ... 13VDC		1	red	white
	GND		2	black	brown
	Vcc Sense (optional)		3	white	green
	GND Sense (optional)		4	brown	yellow
	Do not connect		5	-	-
	Do not connect		6	-	-
	Sin+		7	yellow	grey
	Sin-		8	orange	pink
	Cos+		9	green	blue
	Cos-		10	blue	red
	Ref+		11	-	black
	Ref-		12	-	purple
	Hall U		13	-	grey-red
	Hall V		14	-	red-blue
	Hall W		15	-	white-green
Temp+ (Pt1000 Char.) ²⁾	Temp+ (PTC 400/20k Char.) ²⁾	Temp+ (KTY84/130 Char.) ²⁾	16	-	yellow-brown
Temp- (Pt1000 Char.) ²⁾	Temp- (PTC 400/20k Char.) ²⁾	Temp- (KTY84/130 Char.) ²⁾	17	-	white-yellow

2) The temperature evaluation circuit must have the same galvanic reference potential as the encoder circuit (supply). It should therefore be connected to the supply GND. For correct evaluation, the connection potentials of the emulated temperature sensor must be in the range of the supply potentials. Valid temperature values can only be measured 50ms after the encoder supply is applied. In the currentless state, a resistance of 200kOhm is measured between pin 16 and 17 is measured. The maximum voltage between pin 16 and 17 must not exceed 16VDC. The maximum current is 15mA.

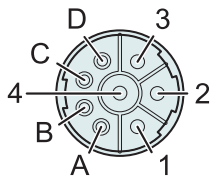

Connector Power Q
View: Motor connector, plug side

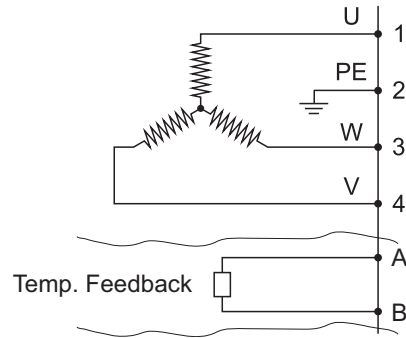

PS10-70X320U-BL-QJ-D04

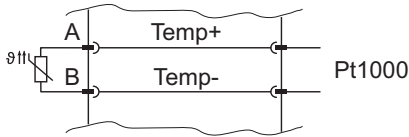

PS10-70X320U-BL-QJ-D05

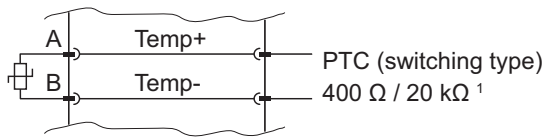

PS10-70X320U-BL-QJ-D08

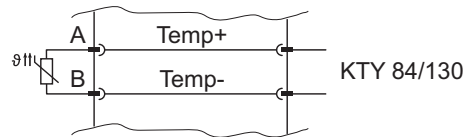

1) $\leq 400 \Omega$ = no error, $\geq 20 \text{ k}\Omega$ = error

Sin/Cos-Interface: Power Connector Wiring					
PS10-70x320U-BL-QJ-D04	PS10-70x320U-BL-QJ-D05	PS10-70x320U-BL-QJ-D08	Connector Power Q	Wire Color Motor Cable KPS15-04	Wire Color Motor Cable KPS15-04/04
Phase U			1	red	red
PE			2	yellow-green	yellow-green
Phase W			3	black	black
Phase V			4	blue	blue
Temp+ (Pt1000) ²⁾	Temp+ (PTC) ²⁾	Temp+ (KTY84/130 Char.) ²⁾	A	n. c.	purple
Temp- (Pt1000) ²⁾	Temp- (PTC) ²⁾	Temp- (KTY84/130 Char.) ²⁾	B	n. c.	grey
n. c.	n. c.	n. c.	C	n. c.	yellow
n. c.	n. c.	n. c.	D	n. c.	brown

2) The temperature evaluation circuit must have the same galvanic reference potential as the encoder circuit (supply). It should therefore be connected to the supply GND. For correct evaluation, the connection potentials of the emulated temperature sensor must be in the range of the supply potentials. Valid temperature values can only be measured 50ms after the encoder supply is applied. In currentless state a resistance of 200kOhm is measured between pin A and B. The maximum voltage between pin A and B must not exceed 16VDC. The maximum current is 15mA.

TEMPERATURE FEEDBACK D04 / D05 / D08

Overheating protection is provided by three internal thermistors embedded in the motor windings. These thermistors are monitored by the motor electronics. A single thermistor is simulated based on the maximum temperature readings. This is done in order to accurately monitor the temperature over the entire length of the stator and to respond as quickly as possible to dynamic changes in a single motor phase. When the temperature of the motor winding reaches its absolute maximum value, the drive amplifier/servo controller must switch off the motor to protect it from overheating damage. Various temperature interfaces – Dx4, Dx5 or Dx8 – are available to support

the temperature evaluation provided by the drive amplifier/servo controller. Depending on the interface and signals used, there are suitable motor cables (see overview table in the Accessories/Motor Cables section).

D04 (Pt1000 dual)

Both the **signal** and **power connectors** feature an emulated **Pt1000 thermistor** for evaluating the maximum motor temperature.

D05 (PTC dual)

Both the **signal** and **power connectors** are fitted with an emulated **PTC thermistor** that switches to high-impedance mode when the maximum motor temperature is exceeded.

D08 (KTY 84/130 dual)

Both the **signal** and **power connectors** feature an emulated **KTY thermistor**, which is used to evaluate the maximum motor temperature.

A/B INCREMENTAL POSITION FEEDBACK (D2X- INTERFACE FOR 3RD PARTY DRIVES)

4

The linear motors of the P10-70 series have a contactless, integrated position feedback, which means that an external encoder is not required.

The position output of the motors with D2x interface is an industry-standard A/B incremental signal with supplementary reference signal (RS422). Hall switch signals are available for commutation. The relationship between the phase current and the position sensor output is shown on the right.

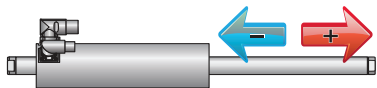

The arrows show the direction of movement of the slider. The stator remains in its position.

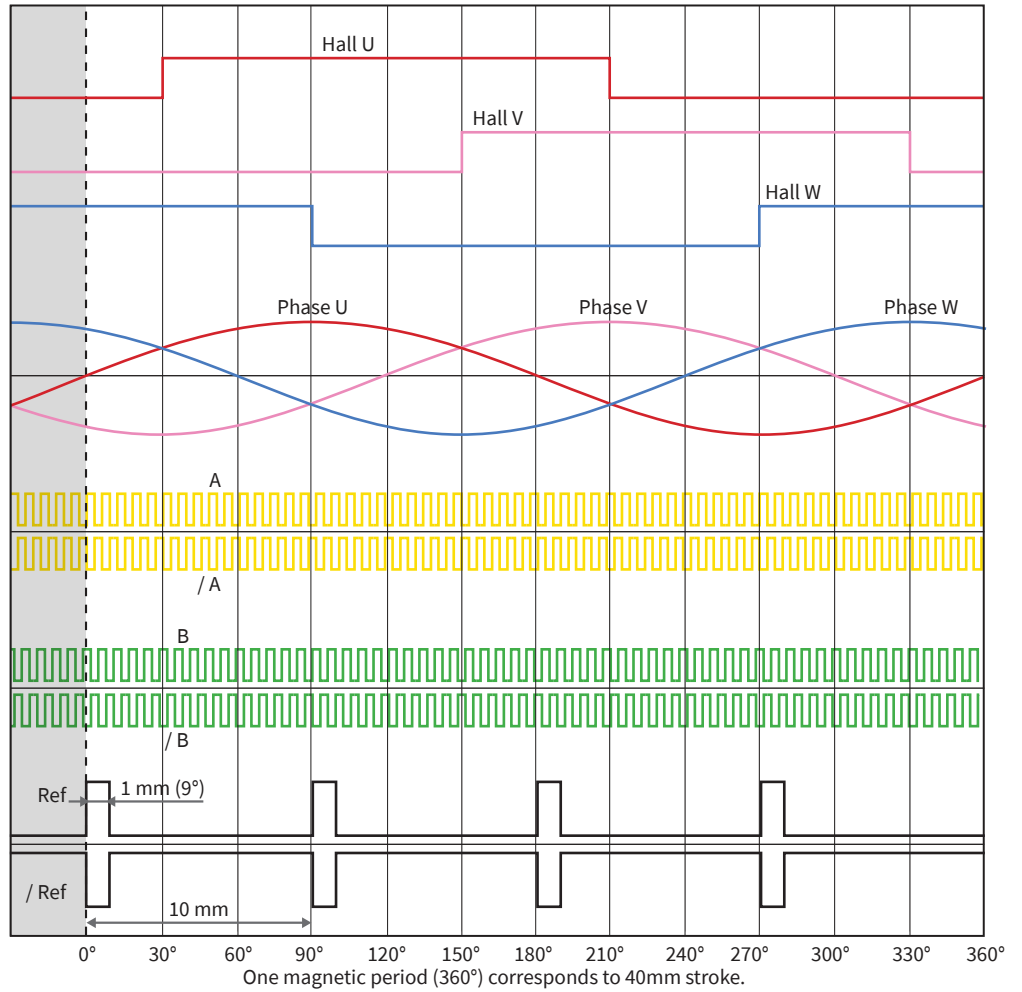

Example:
 Min. pulse interval $t = 500 \text{ ns}$
 For downstream evaluation, at least the following counter frequency is required:
 $f_{\text{counter}} = 1 / \text{pulse interval}$
 $= 1 / 500 \text{ ns} = 2 \text{ MHz}$



The logical state of signals A and B is not defined in relation to the reference signal Ref. The signal shape may differ from the illustration.

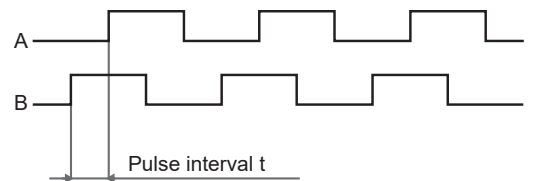

A / B		P10-70x...-D2x	P10-70x...-D2xS
Position Resolution	μm	1	5
Output Type		RS422	
Min. Edge Distance t	ns	100	500
Min. required counter frequency	MHz	10	2
Supply Voltage	Vdc	5-12	
Max. Supply Current	mA	300	300

CONNECTOR PS10-70X320U-BL-QJ-D24 / 24S / 25 / 25S / 26 (A/B-INTERFACE FOR 3RD PARTY DRIVES)

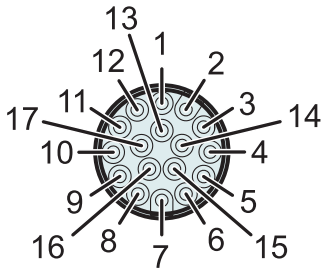

3 ... 13VDC
 (Imax < 150mA @ 5VDC)
 (Imax < 80mA @ 12VDC)

Connector Encoder J

View: Motor connector, plug side

PS10-70X320U-BL-QJ-D24 / D24S

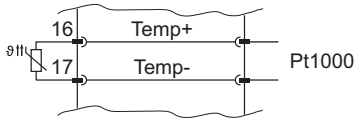

PS10-70X320U-BL-QJ-D25 / D25S

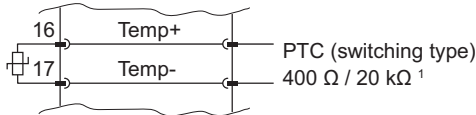

1) ≤ 400 Ω = no error, ≥ 20 kΩ = error

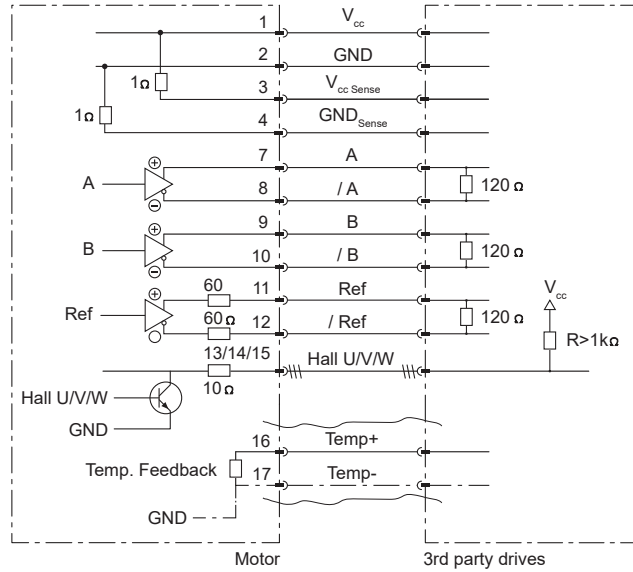

PS10-70X320U-BL-QJ-D26

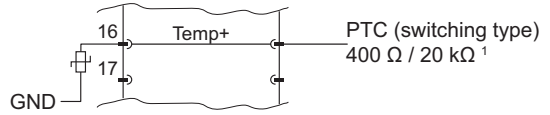

A/B-Interface: Encoder Connector Wiring						
PS10-70x320U-BL-QJ-D24 PS10-70x320U-BL-QJ-D24S	PS10-70x320U-BL-QJ-D25 PS10-70x320U-BL-QJ-D25S	PS10-70x320U-BL-QJ-D26	Connector Encoder J	Wire Color Motor Cable KSS05-02/06	Wire Color Motor Cable KSS05-02/13	
3 ... 13VDC			1	red	white	
GND			2	black	brown	
Vcc Sense (optional)			3	white	green	
GND Sense (optional)			4	brown	yellow	
Do not connect			5	-	-	
Do not connect			6	-	-	
A			7	yellow	grey	
/A			8	orange	pink	
B			9	green	blue	
/B			10	blue	red	
Ref			11	-	black	
/Ref			12	-	purple	
Hall U			13	-	grey-red	
Hall V			14	-	red-blue	
Hall W			15	-	white-green	
Temp+ (Pt1000 Char.) ²⁾	Temp+ (PTC 400/20k Char.) ²⁾	Temp+ (PTC 400/20k Char.) ²⁾	16	-	yellow-brown	
Temp- (Pt1000 Char.) ²⁾	Temp- (PTC 400/20k Char.) ²⁾	Do not connect	17	-	white-yellow	

2) The temperature evaluation circuit must have the same galvanic reference potential as the encoder circuit (supply). It should therefore be connected to the supply GND. For correct evaluation, the connection potentials of the emulated temperature sensor must be in the range of the supply potentials. Valid temperature values can only be measured 50ms after the encoder supply is applied. In the currentless state, a resistance of 200kOhm is measured between pin 16 and 17 is measured. The maximum voltage between pin 16 and 17 must not exceed 16VDC. The maximum current is 15mA.

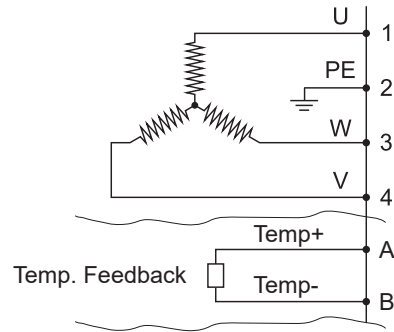
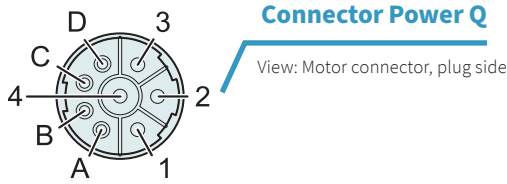

PS10-70X320U-BL-QJ-D24 / D24S

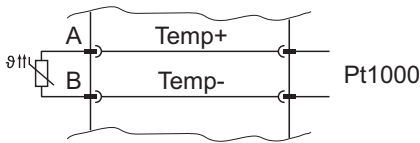

PS10-70X320U-BL-QJ-D25 / D25S

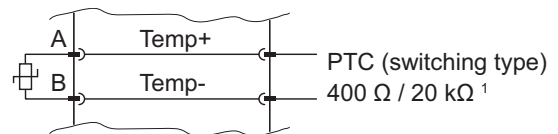

1) unter 400 Ω = no error, über 20 kΩ = error

A/B-Interface: Power Connector Wiring					
PS10-70x320U-BL-QJ-D24 PS10-70x320U-BL-QJ-D24S	PS10-70x320U-BL-QJ-D25 PS10-70x320U-BL-QJ-D25S	PS10-70x320U-BL-QJ-D26	Connector Power Q	Wire Color Motor Cable KPS15-04	Wire Color Motor Cable KPS15-04/04
Phase U			1	red	red
PE			2	yellow-green	yellow-green
Phase W			3	black	black
Phase V			4	blue	blue
Temp+ (Pt1000) ²⁾	Temp+ (PTC) ²⁾	n. c.	A	n. c.	purple
Temp- (Pt1000) ²⁾	Temp- (PTC) ²⁾	n. c.	B	n. c.	grey
n. c.	n. c.	n. c.	C	n. c.	yellow
n. c.	n. c.	n. c.	D	n. c.	brown

2) The temperature evaluation circuit must have the same galvanic reference potential as the encoder circuit (supply). It should therefore be connected to the supply GND. For correct evaluation, the connection potentials of the emulated temperature sensor must be in the range of the supply potentials. Valid temperature values can only be measured 50ms after the encoder supply is applied. In currentless state a resistance of 200kOhm is measured between pin A and B. The maximum voltage between pin A and B must not exceed 16VDC. The maximum current is 15mA.

TEMPERATURE FEEDBACK D24 / D24S / D25 / D25S / D26

Overheating protection is provided by three internal thermistors embedded in the motor windings. These thermistors are monitored by the motor electronics. A single thermistor is simulated based on the maximum temperature readings. This is done in order to accurately monitor the temperature over the entire length of the stator and to respond as quickly as possible to dynamic changes in a single motor phase. If the temperature of the motor winding reaches its absolute maximum value, the drive amplifier/servo controller must switch off the motor to protect it from overheating damage. Various temperature interfaces – DX4, DX5 or DX6 – are available to support the temperature evaluation provided by the

drive amplifier/servo controller. Depending on the interface and signals used, there are suitable motor cables (see overview table in the Accessories/Motor Cables section).

D24 / D24S (Pt1000 dual)

An emulated **Pt1000 thermistor** is available on both the **signal** and **power connectors** for evaluating the maximum motor temperature.

D25 / D25S (PTC dual)

An emulated **PTC thermistor** is available on both the **signal** and **power connectors**, which switches to a high-impedance state when the maximum motor temperature is exceeded.

D26 (PTC)

An emulated PTC thermistor is available on the **signal connector**, which switches to a high-impedance state when the maximum motor temperature is exceeded. The emulated **PTC** is internally **connected to GND on one side**, which is why only an additional signal line is connected to the servo controller for evaluation in addition to the power supply.

BISS-C POSITION FEEDBACK (D3X- INTERFACE FOR 3RD PARTY DRIVES)

The linear motors of the P10-70 series have contactless, integrated position feedback, which means that there is no need for an external encoder.

The position feedback of the motors with D3x interface is based on RS422 and the industry-standard BiSS-C protocol. Either the transmitted position or the hall switch signals can be used for commutation. The relationship between the phase current and the encoder signals is shown on the right.

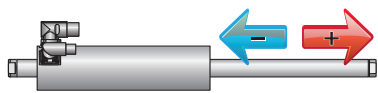

The arrows show the direction of movement of the slider. The stator remains in its position.

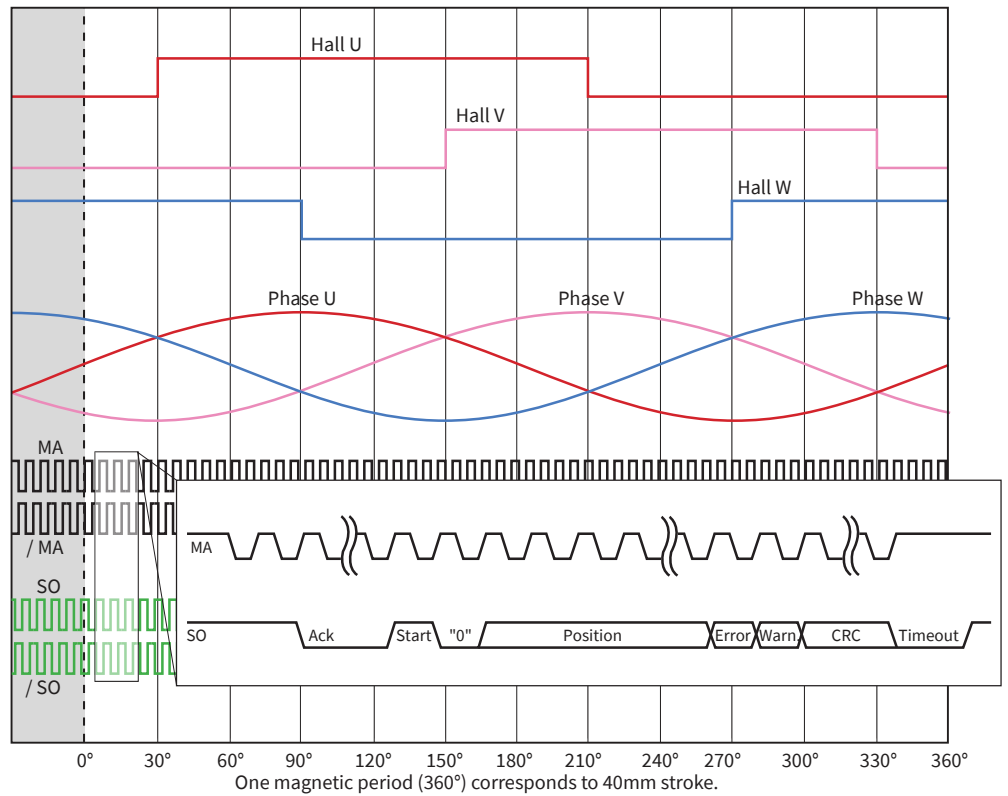

BiSS-C ¹⁾	P10-70x...-D3x			
Singleturn Position Resolution	µm	1		
Output Type		RS422		
MA Clock frequency	MHz	1...3.3		
Max. request cycle rate ²⁾	kHz	16		
Supply Voltage	Vdc	5 -12		
Max. Supply Current	mA	300		
Data Type		SCDS (Single Cycle Data Sensor)		
Data (Bits)		Position	nER	nWA
		Singleturn	1	1
		34		
Data Format and Alignment		Binary coded, MSB first, right aligned		
CRC polynomial		0x43 (X ⁶ + X ¹ + X ⁰) – CRC bit length 6 bits, CRC is inverted		
CRC Starting Value		0x00		
BiSS Timeout (tm)	µs	~20		
Switch-on Delay	ms	100		

1) Compatible with bidirectional interfaces supporting EDS register access and unidirectional interfaces
 2) Achievable only if the data transmission time is shorter than one request cycle. Recommended MA Clock frequency 2MHz.

Commutation Angle

$$\text{Commutation Angle} = (\text{Position mod magnetic Period}) \cdot \frac{360^\circ}{\text{Magnetic Period}}$$

First, the position data is reduced to the range within a magnetic period using modulo.

This relative position value is then converted into an electrical angle.

BISS-C-FRAME DESCRIPTION

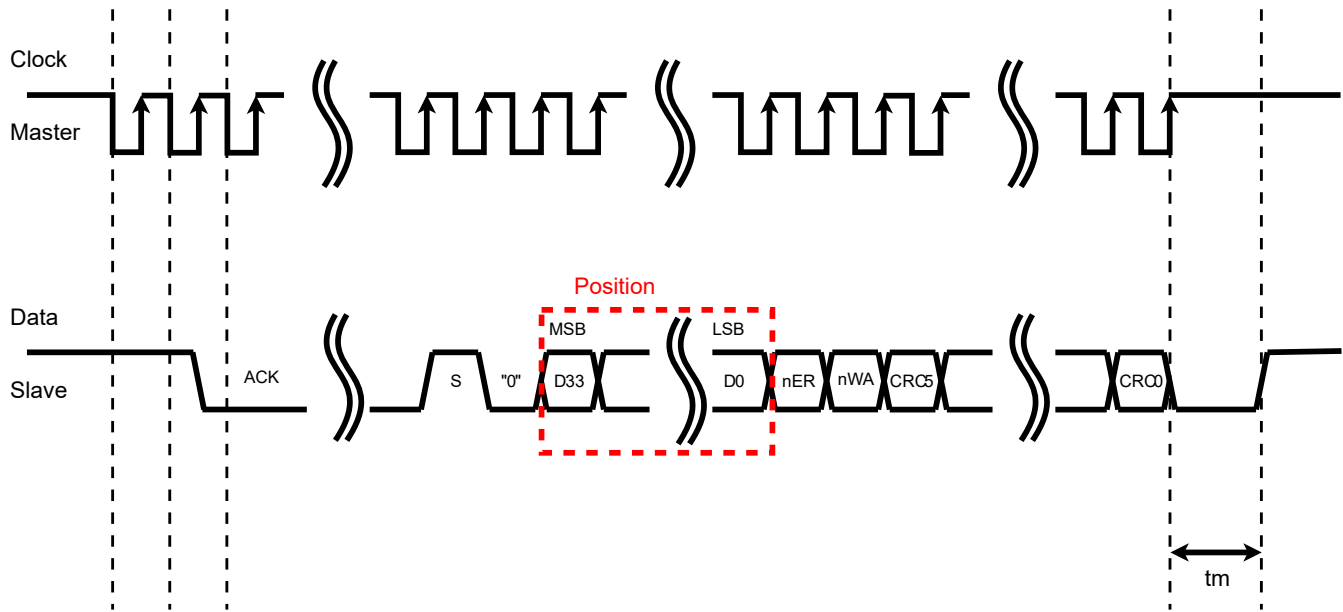
**Singleturn Position 34 Bit: D33-D0**

Binary coded, MSB first
 Resolution per bit = 1 μ m
 After switching on the encoder, the position starts with an offset of 3 m. In addition to the offset, the current position angle of the slider within a pole pair (magnetic period) of the motor is added to this. This position can be used for commutation.

Errorbit: nER

0: error; 1: no error (active low).
 Indicates an encoder error. If this bit indicates an error, the position must be treated as invalid.

Warnbit: nWA

0: warning; 1: no warning (active low).
 Displays encoder warnings. The position is still valid if only a warning is displayed.

CRC 6 Bit: CRC5-0

Polynomial: 0x43
 Initial value: 0x00
 The CRC is calculated via position, error and warning bits.
 It is transmitted with MSB first and inverted. The start bit and the "0" bit are omitted from the CRC calculation.

Register and Memory Definitions

A description of how a BiSS-C master can access registers can be found at www.biss-interface.com.

BiSS-C - XML

The encoder is compatible with the "Standard Encoder Profile (BP3)".
 The function of the XML file is to automatically assign device properties in the master using the BiSS identifier.
 The XML file can be used by masters to facilitate the configuration of slave devices. It can be downloaded from www.linmot.com.

CONNECTOR PS10-70X320U-BL-QJ-D34 (BISS-C INTERFACE FOR 3RD PARTY DRIVES)

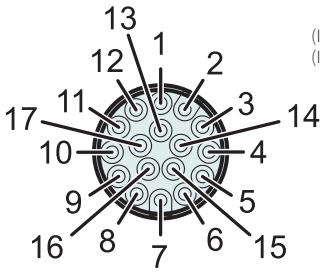

3 ... 13VDC
 (I_{max} < 150mA @ 5VDC)
 (I_{max} < 80mA @ 12VDC)

Connector Encoder J

View: Motor connector, plug side

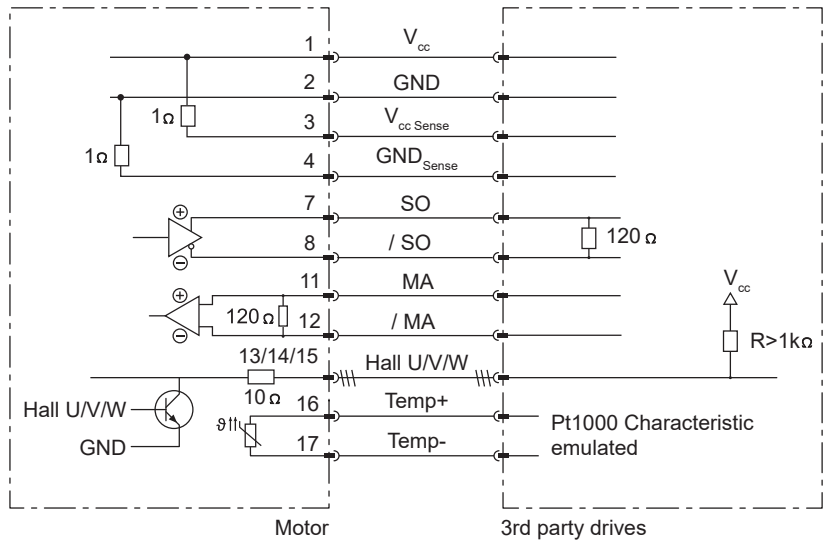

BiSS-C-Interface: Encoder Connector Wiring			
PS10-70x320U-BL-QJ-D34	Function	Connector Encoder J	Wire Color Motor Cable KSS05-02/13
3 ... 13VDC	Supply	1	white
GND	Supply	2	brown
Vcc Sense (optional)	Supply Sense	3	green
GND Sense (optional)	Supply Sense	4	yellow
Do not connect	-	5	-
Do not connect	-	6	-
SO (Slave out)	Encoder RS422	7	grey
/ SO (Slave out)	Encoder RS422	8	pink
Do not connect	-	9	blue
Do not connect	-	10	red
MA (Master clock)	Encoder RS422	11	black
/ MA (Master clock)	Encoder RS422	12	purple
Hall U	Encoder (open collector)	13	grey-red
Hall V	Encoder (open collector)	14	red-blue
Hall W	Encoder (open collector)	15	white-green
Temp+ (Pt1000)	Temperature ¹	16	yellow-brown
Temp- (Pt1000)	Temperature ¹	17	white-yellow

1) The temperature evaluation circuit must have the same galvanic reference potential as the encoder circuit (supply). It should therefore be connected to the supply GND. For correct evaluation, the connection potentials of the emulated temperature sensor must be in the range of the supply potentials. Valid temperature values can only be measured 50ms after the encoder supply is applied. In the currentless state, a resistance of 200kOhm is measured between pin 16 and 17 is measured. The maximum voltage between pin 16 and 17 must not exceed 16VDC. The maximum current is 15mA.

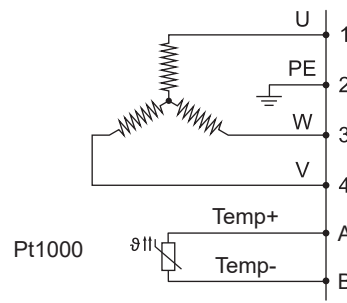
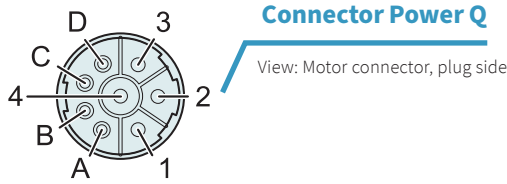

BiSS-C-Interface: Power Connector Wiring			
PS10-70x320U-BL-QJ-D34	Connector Power Q	Wire Color Motor Cable KPS15-04	Wire Color Motor Cable KPS15-04/04
Phase U	1	red	red
PE	2	yellow-green	yellow-green
Phase W	3	black	black
Phase V	4	blue	blue
Pt1000+ ¹⁾	A	n. c.	purple
Pt1000- ¹⁾	B	n. c.	grey
n. c.	C	n. c.	yellow
n. c.	D	n. c.	brown

1) The temperature evaluation circuit must have the same galvanic reference potential as the encoder circuit (supply). It should therefore be connected to the supply GND. For correct evaluation, the connection potentials of the emulated temperature sensor must be in the range of the supply potentials. Valid temperature values can only be measured 50ms after the encoder supply is applied. In currentless state a resistance of 200kOhm is measured between pin A and B. The maximum voltage between pin A and B must not exceed 16VDC. The maximum current is 15mA.

TEMPERATURE FEEDBACK DX4

Overheating protection is provided by three internal thermistors embedded in the motor windings. These thermistors are monitored by the motor electronics. A single thermistor is simulated based on the maximum temperature readings. This is done in order to accurately monitor the temperature over the entire length of the stator and to react as quickly as possible to dynamic changes in a single motor phase. If the temperature

of the motor winding reaches its absolute maximum value, the drive amplifier/servo controller must switch off the motor to protect it from damage due to overheating. A DX4 temperature interface is available to support the temperature evaluation provided by the drive amplifier/servo controller. LinMot offers the appropriate motor cables for this purpose (see overview table in the Accessories/Motor Cables section).

D34 (Pt1000 dual)

Both the **signal** and **power connectors** feature an emulated **Pt1000 thermistor** for evaluating the maximum motor temperature.

SLIDER

Slider Standard

The groove marks the front slider end.

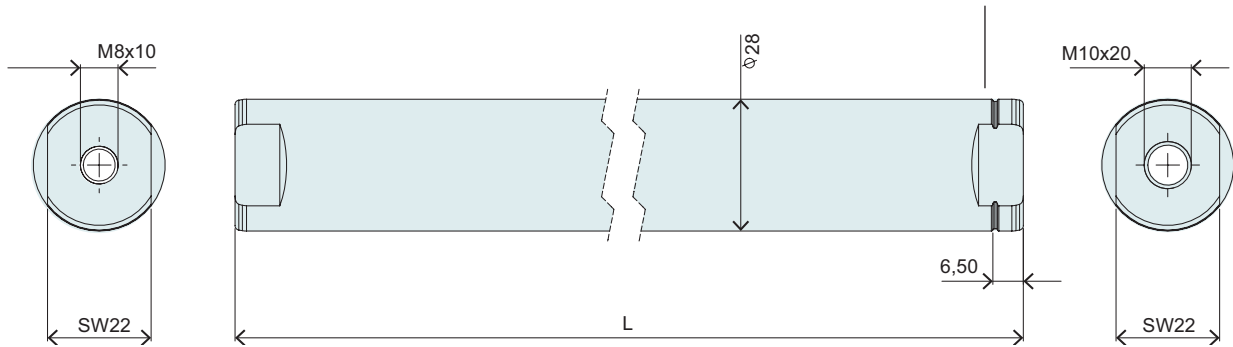

Slider Standard			
Item	Description	Max. Stroke [mm]	Item-No.
PL10-28x490/440	Slider for P10-70 'standard'	30	0150-2195
PL10-28x590/540	Slider for P10-70 'standard'	130	0150-2196
PL10-28x690/640	Slider for P10-70 'standard'	230	0150-2197
PL10-28x790/740	Slider for P10-70 'standard'	330	0150-2198
PL10-28x890/840	Slider for P10-70 'standard'	430	0150-2199
PL10-28x990/940	Slider for P10-70 'standard'	530	0150-2203
PL10-28x1190/1140	Slider for P10-70 'standard'	730	0150-2204
PL10-28x1390/1340	Slider for P10-70 'standard'	930	0150-2205
PL10-28x1590/1540	Slider for P10-70 'standard'	1130	0150-2206
PL10-28x1790/1740	Slider for P10-70 'standard'	1330	0150-2207
PL10-28x1990/1940	Slider for P10-70 'standard'	1530	0150-2208

P10-70x320U/30-BL-QJ

Max. Stroke: 30 mm
Peak Force: 2180 N

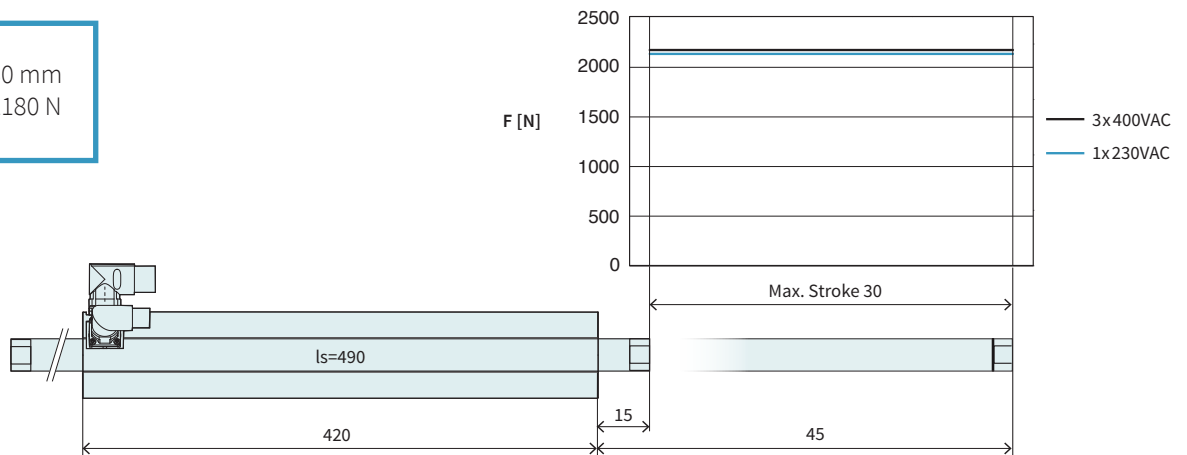

Dimensions in mm

Stroke			
Max. Stroke	mm (in)		30 (1.17)
Force			
Max. Force ¹ @ 1x230VAC	N (lbf)		2170 (487)
Max. Force ¹ @ 3x400VAC	N (lbf)		2180 (489)
Max. Cont. Force [Passive cooling / Fan / Fluid]	N (lbf)		260 / 400 / 700 (58 / 89 / 160)
Max. Border Force relative	%		100
Force Constant 1	N/A _{pk} (lbf/A _{pk})		64 (14.4)
Force Constant 2	N/A _{rms} (lbf/A _{rms})		90.5 (20.3)
Velocity			
Max. Velocity @ 1x230VAC	m/s (in/s)		2.8 (109.9)
Max. Velocity @ 3x400VAC	m/s (in/s)		4.9 (192.3)
Position Detection			
Repeatability	mm (in)		±0.05 (±0.002)
Linearity	%		± 1.75
Electrical Data			
Max. Current ¹ @ 1x230VAC	A _{pk} / A _{rms}		33.7 / 23.8
Max. Current ¹ @ 3x400VAC	A _{pk} / A _{rms}		33.9 / 23.9
Max. Cont. Current 1 [Passive cooling / Fan / Fluid]	A _{pk}		4.1 / 6.2 / 11
Max. Cont. Current 2 [Passive cooling / Fan / Fluid]	A _{rms}		2.9 / 4.4 / 7.7
Thermal Data			
Max. Winding Temperature (Sensor)	°C		90
Thermal Resistance [Passive cooling / Fan / Fluid]	°K/W		0.65 / 0.28 / 0.09
Thermal Time Constant [Passive cooling / Fan / Fluid]	s		2100 / 500 / 110
Mechanical Data			
Slider Length	mm (in)		490 (19)
Slider Mass	g (lb)		2300 (5.06)

1) Real time calculation of motor winding temperature is required (including monitoring).
 If temperature monitoring is only based on temperature sensor signal (missing thermal model calculation), 60 % of the peak value has to be taken instead.



Item	Description	Item-No.
PS10-70x320U-BL-QJ	Stator 3x400VAC, LinMot Encoder	0150-1284
PS10-70x320U-BL-QJ-D04	Stator 3x400VAC, Sin/Cos Encoder 1Vpp, Pt1000 dual	0150-4263
PS10-70x320U-BL-QJ-D05	Stator 3x400VAC, Sin/Cos Encoder 1Vpp, PTC dual	0150-4608
PS10-70x320U-BL-QJ-D08	Stator 3x400VAC, Sin/Cos Encoder 1Vpp, KTY dual	0150-4513
PS10-70x320U-BL-QJ-D24	Stator 3x400VAC, A/B Encoder 1µm, Pt1000 dual	0150-4133
PS10-70x320U-BL-QJ-D24S	Stator 3x400VAC, A/B Encoder 5µm, Pt1000 dual	0150-4598
PS10-70x320U-BL-QJ-D25	Stator 3x400VAC, A/B Encoder 1µm, PTC dual	0150-5763
PS10-70x320U-BL-QJ-D25S	Stator 3x400VAC, A/B Encoder 5µm, PTC dual	0150-4603
PS10-70x320U-BL-QJ-D26	Stator 3x400VAC, A/B Encoder 1µm, PTC single ended	0150-4517
PS10-70x320U-BL-QJ-D34	Stator 3x400VAC, BiSS-C, Pt1000 dual	0150-4873
PL10-28x490/440	Slider for P10-70 'standard'	0150-2195

P10-70x320U/130-BL-QJ

Max. Stroke: 130 mm
Peak Force: 2180 N

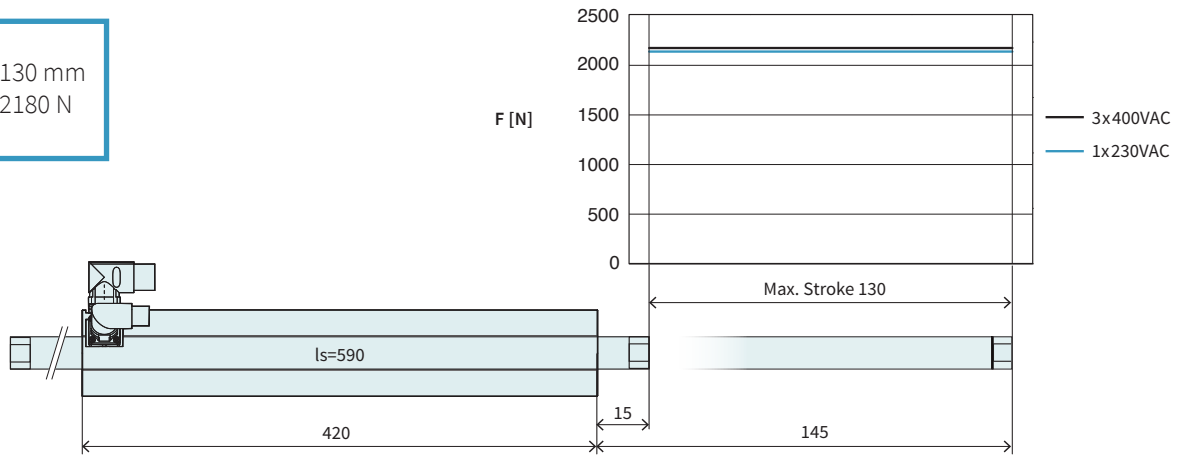

Dimensions in mm

Stroke			
Max. Stroke	mm (in)		130 (5.12)
Force			
Max. Force ¹ @ 1x230VAC	N (lbf)		2170 (487)
Max. Force ¹ @ 3x400VAC	N (lbf)		2180 (489)
Max. Cont. Force [Passive cooling / Fan / Fluid]	N (lbf)		260 / 400 / 700 (58 / 89 / 160)
Max. Border Force relative	%		100
Force Constant 1	N/A _{pk} (lbf/A _{pk})		64 (14.4)
Force Constant 2	N/A _{rms} (lbf/A _{rms})		90.5 (20.3)
Velocity			
Max. Velocity @ 1x230VAC	m/s (in/s)		2.8 (109.9)
Max. Velocity @ 3x400VAC	m/s (in/s)		4.9 (192.3)
Position Detection			
Repeatability	mm (in)		±0.05 (±0.002)
Linearity	%		± 0.5
Electrical Data			
Max. Current ¹ @ 1x230VAC	A _{pk} / A _{rms}		33.7 / 23.8
Max. Current ¹ @ 3x400VAC	A _{pk} / A _{rms}		33.9 / 23.9
Max. Cont. Current 1 [Passive cooling / Fan / Fluid]	A _{pk}		4.1 / 6.2 / 11
Max. Cont. Current 2 [Passive cooling / Fan / Fluid]	A _{rms}		2.9 / 4.4 / 7.7
Thermal Data			
Max. Winding Temperature (Sensor)	°C		90
Thermal Resistance [Passive cooling / Fan / Fluid]	°K/W		0.65 / 0.28 / 0.09
Thermal Time Constant [Passive cooling / Fan / Fluid]	s		2100 / 500 / 110
Mechanical Data			
Slider Length	mm (in)		590 (23)
Slider Mass	g (lb)		2770 (6.09)

1) Real time calculation of motor winding temperature is required (including monitoring).
 If temperature monitoring is only based on temperature sensor signal (missing thermal model calculation), 60 % of the peak value has to be taken instead.



Item	Description	Item-No.
PS10-70x320U-BL-QJ	Stator 3x400VAC, LinMot Encoder	0150-1284
PS10-70x320U-BL-QJ-D04	Stator 3x400VAC, Sin/Cos Encoder 1Vpp, Pt1000 dual	0150-4263
PS10-70x320U-BL-QJ-D05	Stator 3x400VAC, Sin/Cos Encoder 1Vpp, PTC dual	0150-4608
PS10-70x320U-BL-QJ-D08	Stator 3x400VAC, Sin/Cos Encoder 1Vpp, KTY dual	0150-4513
PS10-70x320U-BL-QJ-D24	Stator 3x400VAC, A/B Encoder 1µm, Pt1000 dual	0150-4133
PS10-70x320U-BL-QJ-D24S	Stator 3x400VAC, A/B Encoder 5µm, Pt1000 dual	0150-4598
PS10-70x320U-BL-QJ-D25	Stator 3x400VAC, A/B Encoder 1µm, PTC dual	0150-5763
PS10-70x320U-BL-QJ-D25S	Stator 3x400VAC, A/B Encoder 5µm, PTC dual	0150-4603
PS10-70x320U-BL-QJ-D26	Stator 3x400VAC, A/B Encoder 1µm, PTC single ended	0150-4517
PS10-70x320U-BL-QJ-D34	Stator 3x400VAC, BiSS-C, Pt1000 dual	0150-4873
PL10-28x590/540	Slider for P10-70 'standard'	0150-2196

P10-70x320U/230-BL-QJ

Max. Stroke: 230 mm
Peak Force: 2180 N

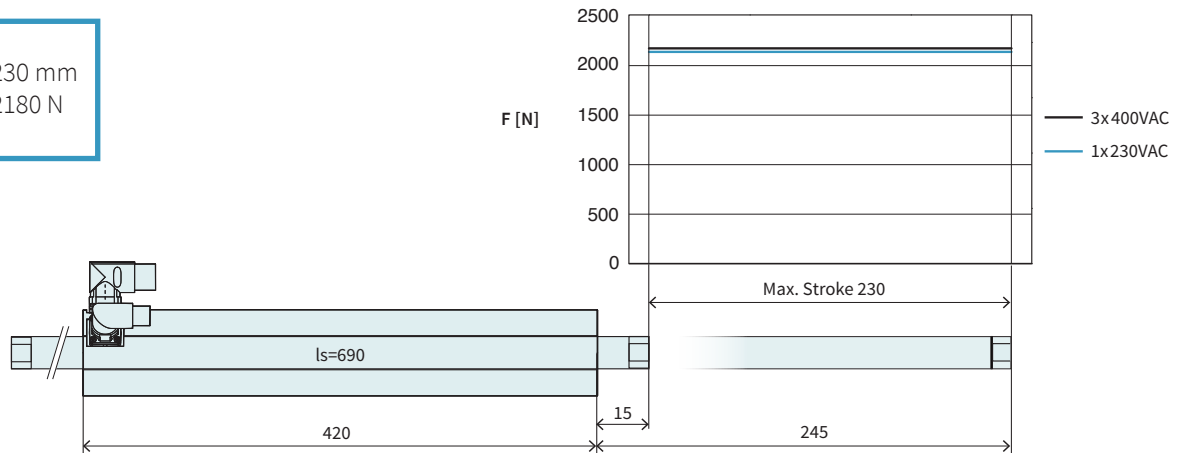

Dimensions in mm

Stroke			
Max. Stroke	mm (in)		230 (9.06)
Force			
Max. Force ¹ @ 1x230VAC	N (lbf)		2170 (487)
Max. Force ¹ @ 3x400VAC	N (lbf)		2180 (489)
Max. Cont. Force [Passive cooling/ Fan / Fluid]	N (lbf)		260 / 400 / 700 (58 / 89 / 160)
Max. Border Force relative	%		100
Force Constant 1	N/A _{pk} (lbf/A _{pk})		64 (14.4)
Force Constant 2	N/A _{rms} (lbf/A _{rms})		90.5 (20.3)
Velocity			
Max. Velocity @ 1x230VAC	m/s (in/s)		2.8 (109.9)
Max. Velocity @ 3x400VAC	m/s (in/s)		4.9 (192.3)
Position Detection			
Repeatability	mm (in)		±0.05 (±0.002)
Linearity	%		± 0.3
Electrical Data			
Max. Current ¹ @ 1x230VAC	A _{pk} / A _{rms}		33.7 / 23.8
Max. Current ¹ @ 3x400VAC	A _{pk} / A _{rms}		33.9 / 23.9
Max. Cont. Current 1 [Passive cooling / Fan / Fluid]	A _{pk}		4.1 / 6.2 / 11
Max. Cont. Current 2 [Passive cooling / Fan / Fluid]	A _{rms}		2.9 / 4.4 / 7.7
Thermal Data			
Max. Winding Temperature (Sensor)	°C		90
Thermal Resistance [Passive cooling / Fan / Fluid]	°K/W		0.65 / 0.28 / 0.09
Thermal Time Constant [Passive cooling / Fan / Fluid]	s		2100 / 500 / 110
Mechanical Data			
Slider Length	mm (in)		690 (27)
Slider Mass	g (lb)		3240 (7.13)

1) Real time calculation of motor winding temperature is required (including monitoring).
 If temperature monitoring is only based on temperature sensor signal (missing thermal model calculation), 60 % of the peak value has to be taken instead.

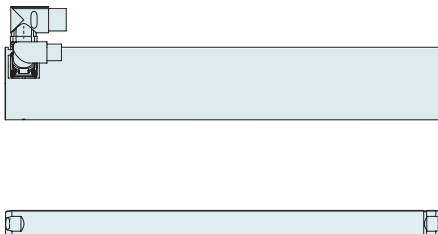

Item	Description	Item-No.
PS10-70x320U-BL-QJ	Stator 3x400VAC, LinMot Encoder	0150-1284
PS10-70x320U-BL-QJ-D04	Stator 3x400VAC, Sin/Cos Encoder 1Vpp, Pt1000 dual	0150-4263
PS10-70x320U-BL-QJ-D05	Stator 3x400VAC, Sin/Cos Encoder 1Vpp, PTC dual	0150-4608
PS10-70x320U-BL-QJ-D08	Stator 3x400VAC, Sin/Cos Encoder 1Vpp, KTY dual	0150-4513
PS10-70x320U-BL-QJ-D24	Stator 3x400VAC, A/B Encoder 1µm, Pt1000 dual	0150-4133
PS10-70x320U-BL-QJ-D24S	Stator 3x400VAC, A/B Encoder 5µm, Pt1000 dual	0150-4598
PS10-70x320U-BL-QJ-D25	Stator 3x400VAC, A/B Encoder 1µm, PTC dual	0150-5763
PS10-70x320U-BL-QJ-D25S	Stator 3x400VAC, A/B Encoder 5µm, PTC dual	0150-4603
PS10-70x320U-BL-QJ-D26	Stator 3x400VAC, A/B Encoder 1µm, PTC single ended	0150-4517
PS10-70x320U-BL-QJ-D34	Stator 3x400VAC, BiSS-C, Pt1000 dual	0150-4873
PL10-28x690/640	Slider for P10-70 'standard'	0150-2197

P10-70x320U/330-BL-QJ

Max. Stroke: 330 mm
Peak Force: 2180 N

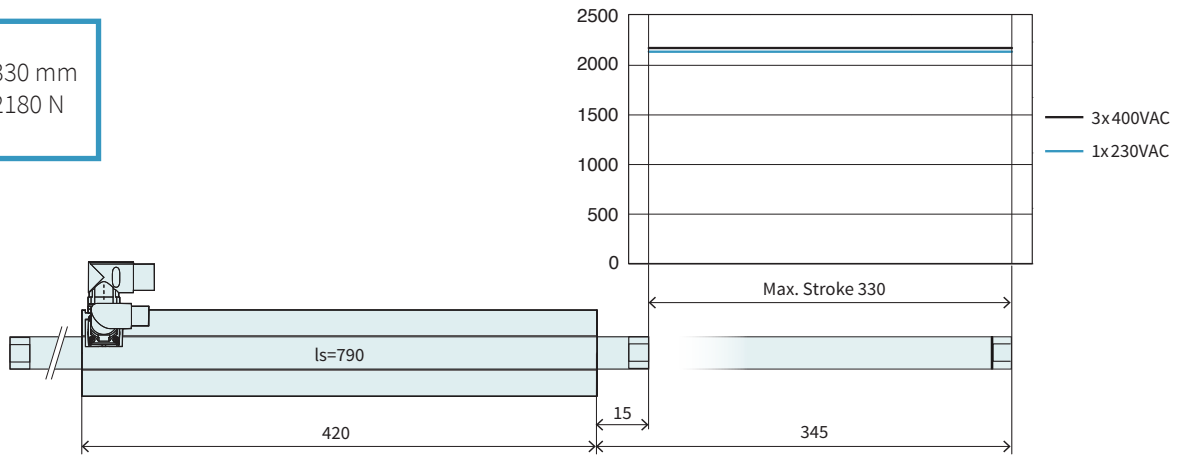

Dimensions in mm

Stroke			
Max. Stroke	mm (in)		330 (12.99)
Force			
Max. Force ¹ @ 1x230VAC	N (lbf)		2170 (487)
Max. Force ¹ @ 3x400VAC	N (lbf)		2180 (489)
Max. Cont. Force [Passive cooling / Fan / Fluid]	N (lbf)		260 / 400 / 700 (58 / 89 / 160)
Max. Border Force relative	%		100
Force Constant 1	N/A _{pk} (lbf/A _{pk})		64 (14.4)
Force Constant 2	N/A _{rms} (lbf/A _{rms})		90.5 (20.3)
Velocity			
Max. Velocity @ 1x230VAC	m/s (in/s)		2.8 (109.9)
Max. Velocity @ 3x400VAC	m/s (in/s)		4.9 (192.3)
Position Detection			
Repeatability	mm (in)		±0.05 (±0.002)
Linearity	%		± 0.25
Electrical Data			
Max. Current ¹ @ 1x230VAC	A _{pk} / A _{rms}		33.7 / 23.8
Max. Current ¹ @ 3x400VAC	A _{pk} / A _{rms}		33.9 / 23.9
Max. Cont. Current 1 [Passive cooling / Fan / Fluid]	A _{pk}		4.1 / 6.2 / 11
Max. Cont. Current 2 [Passive cooling / Fan / Fluid]	A _{rms}		2.9 / 4.4 / 7.7
Thermal Data			
Max. Winding Temperature (Sensor)	°C		90
Thermal Resistance [Passive cooling / Fan / Fluid]	°K/W		0.65 / 0.28 / 0.09
Thermal Time Constant [Passive cooling / Fan / Fluid]	s		2100 / 500 / 110
Mechanical Data			
Slider Length	mm (in)		790 (31)
Slider Mass	g (lb)		3710 (8.16)

1) Real time calculation of motor winding temperature is required (including monitoring).
 If temperature monitoring is only based on temperature sensor signal (missing thermal model calculation), 60 % of the peak value has to be taken instead.



Item	Description	Item-No.
PS10-70x320U-BL-QJ	Stator 3x400VAC, LinMot Encoder	0150-1284
PS10-70x320U-BL-QJ-D04	Stator 3x400VAC, Sin/Cos Encoder 1Vpp, Pt1000 dual	0150-4263
PS10-70x320U-BL-QJ-D05	Stator 3x400VAC, Sin/Cos Encoder 1Vpp, PTC dual	0150-4608
PS10-70x320U-BL-QJ-D08	Stator 3x400VAC, Sin/Cos Encoder 1Vpp, KTY dual	0150-4513
PS10-70x320U-BL-QJ-D24	Stator 3x400VAC, A/B Encoder 1µm, Pt1000 dual	0150-4133
PS10-70x320U-BL-QJ-D24S	Stator 3x400VAC, A/B Encoder 5µm, Pt1000 dual	0150-4598
PS10-70x320U-BL-QJ-D25	Stator 3x400VAC, A/B Encoder 1µm, PTC dual	0150-5763
PS10-70x320U-BL-QJ-D25S	Stator 3x400VAC, A/B Encoder 5µm, PTC dual	0150-4603
PS10-70x320U-BL-QJ-D26	Stator 3x400VAC, A/B Encoder 1µm, PTC single ended	0150-4517
PS10-70x320U-BL-QJ-D34	Stator 3x400VAC, BiSS-C, Pt1000 dual	0150-4873
PL10-28x790/740	Slider for P10-70 'standard'	0150-2198

P10-70x320U/430-BL-QJ

Max. Stroke: 430 mm
Peak Force: 2180 N

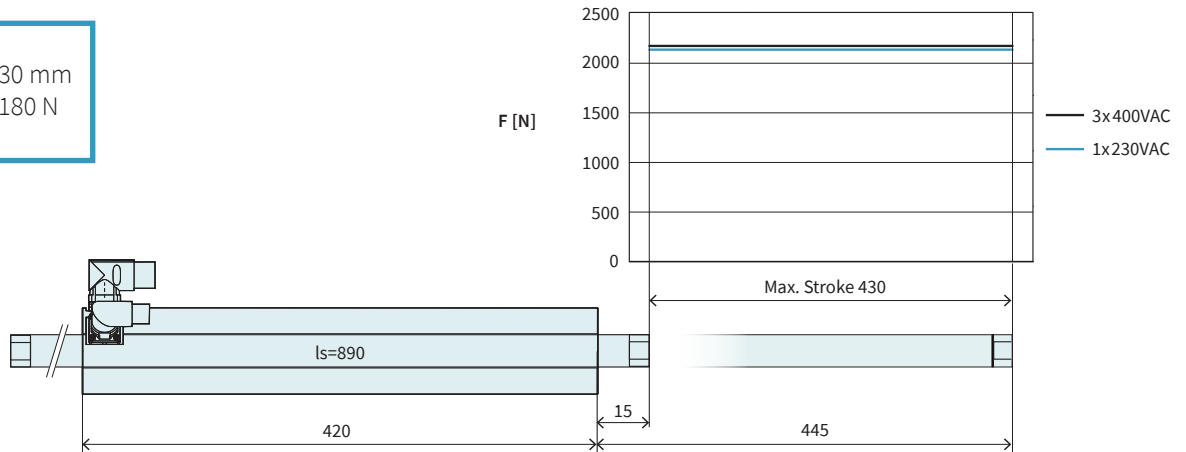

Dimensions in mm

Stroke			
Max. Stroke	mm (in)		430 (16.89)
Force			
Max. Force ¹ @ 1x230VAC	N (lbf)		2170 (487)
Max. Force ¹ @ 3x400VAC	N (lbf)		2180 (489)
Max. Cont. Force [Passive cooling / Fan / Fluid]	N (lbf)		260 / 400 / 700 (58 / 89 / 160)
Max. Border Force relative	%		100
Force Constant 1	N/A _{pk} (lbf/A _{pk})		64 (14.4)
Force Constant 2	N/A _{rms} (lbf/A _{rms})		90.5 (20.3)
Velocity			
Max. Velocity @ 1x230VAC	m/s (in/s)		2.8 (109.9)
Max. Velocity @ 3x400VAC	m/s (in/s)		4.9 (192.3)
Position Detection			
Repeatability	mm (in)		±0.05 (±0.002)
Linearity	%		± 0.2
Electrical Data			
Max. Current ¹ @ 1x230VAC	A _{pk} / A _{rms}		33.7 / 23.8
Max. Current ¹ @ 3x400VAC	A _{pk} / A _{rms}		33.9 / 23.9
Max. Cont. Current 1 [Passive cooling / Fan / Fluid]	A _{pk}		4.1 / 6.2 / 11
Max. Cont. Current 2 [Passive cooling / Fan / Fluid]	A _{rms}		2.9 / 4.4 / 7.7
Thermal Data			
Max. Winding Temperature (Sensor)	°C		90
Thermal Resistance [Passive cooling / Fan / Fluid]	°K/W		0.65 / 0.28 / 0.09
Thermal Time Constant [Passive cooling / Fan / Fluid]	s		2100 / 500 / 110
Mechanical Data			
Slider Length	mm (in)		890 (35)
Slider Mass	g (lb)		4180 (9.2)

1) Real time calculation of motor winding temperature is required (including monitoring).
 If temperature monitoring is only based on temperature sensor signal (missing thermal model calculation), 60 % of the peak value has to be taken instead.

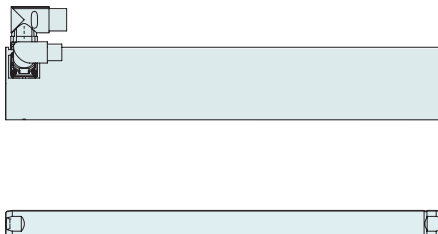

Item	Description	Item-No.
PS10-70x320U-BL-QJ	Stator 3x400VAC, LinMot Encoder	0150-1284
PS10-70x320U-BL-QJ-D04	Stator 3x400VAC, Sin/Cos Encoder 1Vpp, Pt1000 dual	0150-4263
PS10-70x320U-BL-QJ-D05	Stator 3x400VAC, Sin/Cos Encoder 1Vpp, PTC dual	0150-4608
PS10-70x320U-BL-QJ-D08	Stator 3x400VAC, Sin/Cos Encoder 1Vpp, KTY dual	0150-4513
PS10-70x320U-BL-QJ-D24	Stator 3x400VAC, A/B Encoder 1µm, Pt1000 dual	0150-4133
PS10-70x320U-BL-QJ-D24S	Stator 3x400VAC, A/B Encoder 5µm, Pt1000 dual	0150-4598
PS10-70x320U-BL-QJ-D25	Stator 3x400VAC, A/B Encoder 1µm, PTC dual	0150-5763
PS10-70x320U-BL-QJ-D25S	Stator 3x400VAC, A/B Encoder 5µm, PTC dual	0150-4603
PS10-70x320U-BL-QJ-D26	Stator 3x400VAC, A/B Encoder 1µm, PTC single ended	0150-4517
PS10-70x320U-BL-QJ-D34	Stator 3x400VAC, BiSS-C, Pt1000 dual	0150-4873
PL10-28x890/840	Slider for P10-70 'standard'	0150-2199

P10-70x320U/530-BL-QJ

Max. Stroke: 530 mm
Peak Force: 2180 N

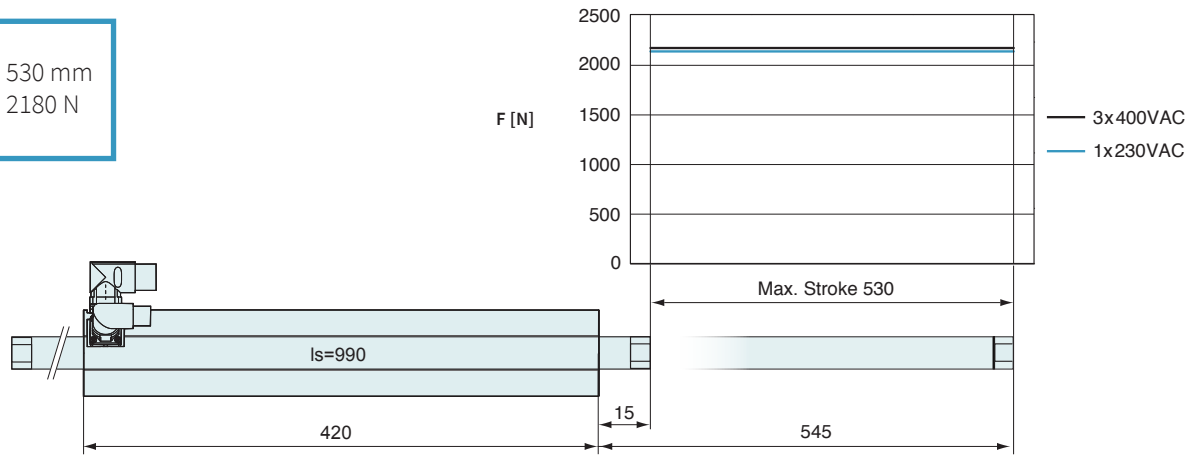

Dimensions in mm

Stroke			
Max. Stroke	mm (in)		530 (20.89)
Force			
Max. Force ¹ @ 1x230VAC	N (lbf)		2170 (487)
Max. Force ¹ @ 3x400VAC	N (lbf)		2180 (489)
Max. Cont. Force [Passive cooling / Fan / Fluid]	N (lbf)		260 / 400 / 700 (58 / 89 / 160)
Max. Border Force relative	%		100
Force Constant 1	N/A _{pk} (lbf/A _{pk})		64 (14.4)
Force Constant 2	N/A _{rms} (lbf/A _{rms})		90.5 (20.3)
Velocity			
Max. Velocity @ 1x230VAC	m/s (in/s)		2.8 (109.9)
Max. Velocity @ 3x400VAC	m/s (in/s)		4.9 (192.3)
Position Detection			
Repeatability	mm (in)		±0.05 (±0.002)
Linearity	%		± 0.2
Electrical Data			
Max. Current ¹ @ 1x230VAC	A _{pk} / A _{rms}		33.7 / 23.8
Max. Current ¹ @ 3x400VAC	A _{pk} / A _{rms}		33.9 / 23.9
Max. Cont. Current 1 [Passive cooling / Fan / Fluid]	A _{pk}		4.1 / 6.2 / 11
Max. Cont. Current 2 [Passive cooling / Fan / Fluid]	A _{rms}		2.9 / 4.4 / 7.7
Thermal Data			
Max. Winding Temperature (Sensor)	°C		90
Thermal Resistance [Passive cooling / Fan / Fluid]	°K/W		0.65 / 0.28 / 0.09
Thermal Time Constant [Passive cooling / Fan / Fluid]	s		2100 / 500 / 110
Mechanical Data			
Slider Length	mm (in)		990 (39)
Slider Mass	g (lb)		4650 (10.23)

1) Real time calculation of motor winding temperature is required (including monitoring).
 If temperature monitoring is only based on temperature sensor signal (missing thermal model calculation), 60 % of the peak value has to be taken instead.



Item	Description	Item-No.
PS10-70x320U-BL-QJ	Stator 3x400VAC, LinMot Encoder	0150-1284
PS10-70x320U-BL-QJ-D04	Stator 3x400VAC, Sin/Cos Encoder 1Vpp, Pt1000 dual	0150-4263
PS10-70x320U-BL-QJ-D05	Stator 3x400VAC, Sin/Cos Encoder 1Vpp, PTC dual	0150-4608
PS10-70x320U-BL-QJ-D08	Stator 3x400VAC, Sin/Cos Encoder 1Vpp, KTY dual	0150-4513
PS10-70x320U-BL-QJ-D24	Stator 3x400VAC, A/B Encoder 1µm, Pt1000 dual	0150-4133
PS10-70x320U-BL-QJ-D24S	Stator 3x400VAC, A/B Encoder 5µm, Pt1000 dual	0150-4598
PS10-70x320U-BL-QJ-D25	Stator 3x400VAC, A/B Encoder 1µm, PTC dual	0150-5763
PS10-70x320U-BL-QJ-D25S	Stator 3x400VAC, A/B Encoder 5µm, PTC dual	0150-4603
PS10-70x320U-BL-QJ-D26	Stator 3x400VAC, A/B Encoder 1µm, PTC single ended	0150-4517
PS10-70x320U-BL-QJ-D34	Stator 3x400VAC, BiSS-C, Pt1000 dual	0150-4873
PL10-28x990/940	Slider for P10-70 'standard'	0150-2203

P10-70x320U/730-BL-QJ

Max. Stroke: 730 mm
Peak Force: 2180 N

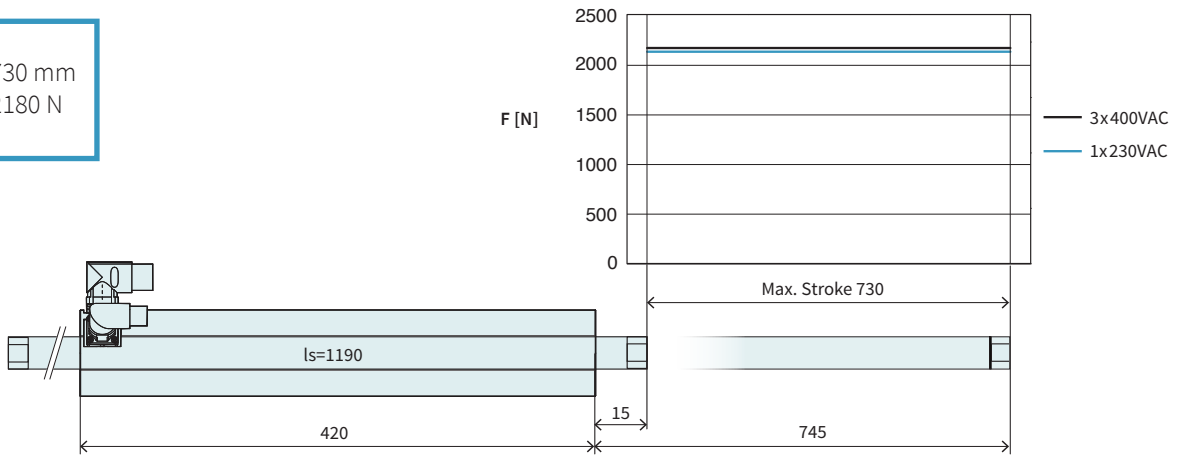

Dimensions in mm

Stroke			
Max. Stroke	mm (in)		730 (28.69)
Force			
Max. Force ¹ @ 1x230VAC	N (lbf)		2170 (487)
Max. Force ¹ @ 3x400VAC	N (lbf)		2180 (489)
Max. Cont. Force [Passive cooling / Fan / Fluid]	N (lbf)		260 / 400 / 700 (58 / 89 / 160)
Max. Border Force relative	%		100
Force Constant 1	N/A _{pk} (lbf/A _{pk})		64 (14.4)
Force Constant 2	N/A _{rms} (lbf/A _{rms})		90.5 (20.3)
Velocity			
Max. Velocity @ 1x230VAC	m/s (in/s)		2.8 (109.9)
Max. Velocity @ 3x400VAC	m/s (in/s)		4.9 (192.3)
Position Detection			
Repeatability	mm (in)		±0.05 (±0.002)
Linearity	%		± 0.15
Electrical Data			
Max. Current ¹ @ 1x230VAC	A _{pk} / A _{rms}		33.7 / 23.8
Max. Current ¹ @ 3x400VAC	A _{pk} / A _{rms}		33.9 / 23.9
Max. Cont. Current 1 [Passive cooling / Fan / Fluid]	A _{pk}		4.1 / 6.2 / 11
Max. Cont. Current 2 [Passive cooling / Fan / Fluid]	A _{rms}		2.9 / 4.4 / 7.7
Thermal Data			
Max. Winding Temperature (Sensor)	°C		90
Thermal Resistance [Passive cooling / Fan / Fluid]	°K/W		0.65 / 0.28 / 0.09
Thermal Time Constant [Passive cooling / Fan / Fluid]	s		2100 / 500 / 110
Mechanical Data			
Slider Length	mm (in)		1190 (47)
Slider Mass	g (lb)		5590 (12.3)

1) Real time calculation of motor winding temperature is required (including monitoring).
 If temperature monitoring is only based on temperature sensor signal (missing thermal model calculation), 60 % of the peak value has to be taken instead.



Item	Description	Item-No.
PS10-70x320U-BL-QJ	Stator 3x400VAC, LinMot Encoder	0150-1284
PS10-70x320U-BL-QJ-D04	Stator 3x400VAC, Sin/Cos Encoder 1Vpp, Pt1000 dual	0150-4263
PS10-70x320U-BL-QJ-D05	Stator 3x400VAC, Sin/Cos Encoder 1Vpp, PTC dual	0150-4608
PS10-70x320U-BL-QJ-D08	Stator 3x400VAC, Sin/Cos Encoder 1Vpp, KTY dual	0150-4513
PS10-70x320U-BL-QJ-D24	Stator 3x400VAC, A/B Encoder 1µm, Pt1000 dual	0150-4133
PS10-70x320U-BL-QJ-D24S	Stator 3x400VAC, A/B Encoder 5µm, Pt1000 dual	0150-4598
PS10-70x320U-BL-QJ-D25	Stator 3x400VAC, A/B Encoder 1µm, PTC dual	0150-5763
PS10-70x320U-BL-QJ-D25S	Stator 3x400VAC, A/B Encoder 5µm, PTC dual	0150-4603
PS10-70x320U-BL-QJ-D26	Stator 3x400VAC, A/B Encoder 1µm, PTC single ended	0150-4517
PS10-70x320U-BL-QJ-D34	Stator 3x400VAC, BiSS-C, Pt1000 dual	0150-4873
PL10-28x1190/1140	Slider for P10-70 'standard'	0150-2204

P10-70x320U/930-BL-QJ

Max. Stroke: 930 mm
Peak Force: 2180 N

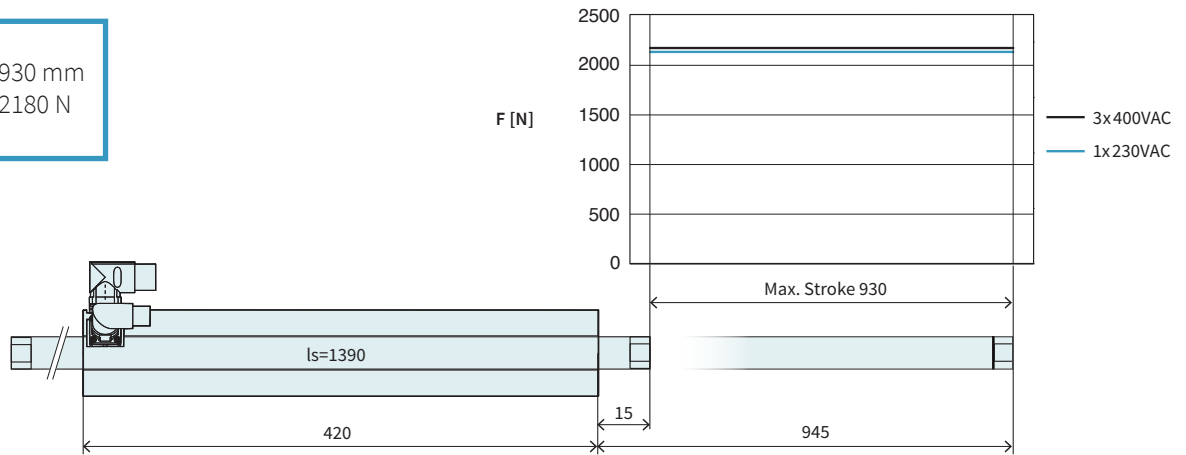

Dimensions in mm

Stroke			
Max. Stroke	mm (in)		930 (36.6)
Force			
Max. Force ¹ @ 1x230VAC	N (lbf)		2170 (487)
Max. Force ¹ @ 3x400VAC	N (lbf)		2180 (489)
Max. Cont. Force [Passive cooling / Fan / Fluid]	N (lbf)		260 / 400 / 700 (58 / 89 / 160)
Max. Border Force relative	%		100
Force Constant 1	N/A _{pk} (lbf/A _{pk})		64 (14.4)
Force Constant 2	N/A _{rms} (lbf/A _{rms})		90.5 (20.3)
Velocity			
Max. Velocity @ 1x230VAC	m/s (in/s)		2.8 (109.9)
Max. Velocity @ 3x400VAC	m/s (in/s)		4.9 (192.3)
Position Detection			
Repeatability	mm (in)		±0.05 (±0.002)
Linearity	%		± 0.15
Electrical Data			
Max. Current ¹ @ 1x230VAC	A _{pk} / A _{rms}		33.7 / 23.8
Max. Current ¹ @ 3x400VAC	A _{pk} / A _{rms}		33.9 / 23.9
Max. Cont. Current 1 [Passive cooling / Fan / Fluid]	A _{pk}		4.1 / 6.2 / 11
Max. Cont. Current 2 [Passive cooling / Fan / Fluid]	A _{rms}		2.9 / 4.4 / 7.7
Thermal Data			
Max. Winding Temperature (Sensor)	°C		90
Thermal Resistance [Passive cooling / Fan / Fluid]	°K/W		0.65 / 0.28 / 0.09
Thermal Time Constant [Passive cooling / Fan / Fluid]	s		2100 / 500 / 110
Mechanical Data			
Slider Length	mm (in)		1390 (55)
Slider Mass	g (lb)		6530 (14.37)

1) Real time calculation of motor winding temperature is required (including monitoring).
 If temperature monitoring is only based on temperature sensor signal (missing thermal model calculation), 60 % of the peak value has to be taken instead.



Item	Description	Item-No.
PS10-70x320U-BL-QJ	Stator 3x400VAC, LinMot Encoder	0150-1284
PS10-70x320U-BL-QJ-D04	Stator 3x400VAC, Sin/Cos Encoder 1Vpp, Pt1000 dual	0150-4263
PS10-70x320U-BL-QJ-D05	Stator 3x400VAC, Sin/Cos Encoder 1Vpp, PTC dual	0150-4608
PS10-70x320U-BL-QJ-D08	Stator 3x400VAC, Sin/Cos Encoder 1Vpp, KTY dual	0150-4513
PS10-70x320U-BL-QJ-D24	Stator 3x400VAC, A/B Encoder 1µm, Pt1000 dual	0150-4133
PS10-70x320U-BL-QJ-D24S	Stator 3x400VAC, A/B Encoder 5µm, Pt1000 dual	0150-4598
PS10-70x320U-BL-QJ-D25	Stator 3x400VAC, A/B Encoder 1µm, PTC dual	0150-5763
PS10-70x320U-BL-QJ-D25S	Stator 3x400VAC, A/B Encoder 5µm, PTC dual	0150-4603
PS10-70x320U-BL-QJ-D26	Stator 3x400VAC, A/B Encoder 1µm, PTC single ended	0150-4517
PS10-70x320U-BL-QJ-D34	Stator 3x400VAC, BiSS-C, Pt1000 dual	0150-4873
PL10-28x1390/1340	Slider for P10-70 'standard'	0150-2205

P10-70x320U/1130-BL-QJ

Max. Stroke: 1130 mm
Peak Force: 2180 N

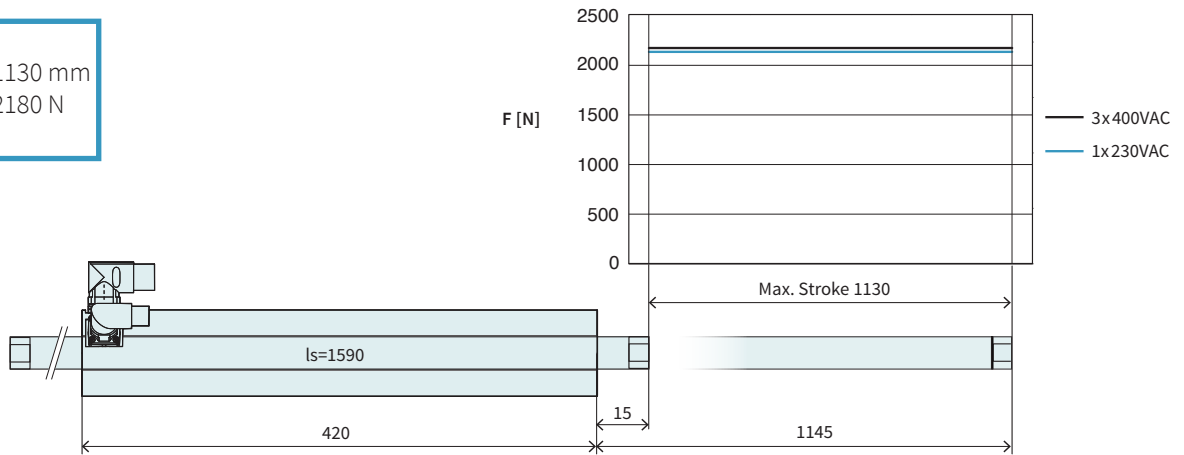

Dimensions in mm

Stroke			
Max. Stroke	mm (in)		1130 (44.49)
Force			
Max. Force ¹ @ 1x230VAC	N (lbf)		2170 (487)
Max. Force ¹ @ 3x400VAC	N (lbf)		2180 (489)
Max. Cont. Force [Passive cooling/ Fan / Fluid]	N (lbf)		260 / 400 / 700 (58 / 89 / 160)
Max. Border Force relative	%		100
Force Constant 1	N/A _{pk} (lbf/A _{pk})		64 (14.4)
Force Constant 2	N/A _{rms} (lbf/A _{rms})		90.5 (20.3)
Velocity			
Max. Velocity @ 1x230VAC	m/s (in/s)		2.8 (109.9)
Max. Velocity @ 3x400VAC	m/s (in/s)		4.9 (192.3)
Position Detection			
Repeatability	mm (in)		±0.05 (±0.002)
Linearity	%		± 0.15
Electrical Data			
Max. Current ¹ @ 1x230VAC	A _{pk} / A _{rms}		33.7 / 23.8
Max. Current ¹ @ 3x400VAC	A _{pk} / A _{rms}		33.9 / 23.9
Max. Cont. Current 1 [Passive cooling / Fan / Fluid]	A _{pk}		4.1 / 6.2 / 11
Max. Cont. Current 2 [Passive cooling / Fan / Fluid]	A _{rms}		2.9 / 4.4 / 7.7
Thermal Data			
Max. Winding Temperature (Sensor)	°C		90
Thermal Resistance [Passive cooling / Fan / Fluid]	°K/W		0.65 / 0.28 / 0.09
Thermal Time Constant [Passive cooling / Fan / Fluid]	s		2100 / 500 / 110
Mechanical Data			
Slider Length	mm (in)		1590 (63)
Slider Mass	g (lb)		7470 (16.43)

1) Real time calculation of motor winding temperature is required (including monitoring).
 If temperature monitoring is only based on temperature sensor signal (missing thermal model calculation), 60 % of the peak value has to be taken instead.



Item	Description	Item-No.
PS10-70x320U-BL-QJ	Stator 3x400VAC, LinMot Encoder	0150-1284
PS10-70x320U-BL-QJ-D04	Stator 3x400VAC, Sin/Cos Encoder 1Vpp, Pt1000 dual	0150-4263
PS10-70x320U-BL-QJ-D05	Stator 3x400VAC, Sin/Cos Encoder 1Vpp, PTC dual	0150-4608
PS10-70x320U-BL-QJ-D08	Stator 3x400VAC, Sin/Cos Encoder 1Vpp, KTY dual	0150-4513
PS10-70x320U-BL-QJ-D24	Stator 3x400VAC, A/B Encoder 1µm, Pt1000 dual	0150-4133
PS10-70x320U-BL-QJ-D24S	Stator 3x400VAC, A/B Encoder 5µm, Pt1000 dual	0150-4598
PS10-70x320U-BL-QJ-D25	Stator 3x400VAC, A/B Encoder 1µm, PTC dual	0150-5763
PS10-70x320U-BL-QJ-D25S	Stator 3x400VAC, A/B Encoder 5µm, PTC dual	0150-4603
PS10-70x320U-BL-QJ-D26	Stator 3x400VAC, A/B Encoder 1µm, PTC single ended	0150-4517
PS10-70x320U-BL-QJ-D34	Stator 3x400VAC, BiSS-C, Pt1000 dual	0150-4873
PL10-28x1590/1540	Slider for P10-70 'standard'	0150-2206

P10-70x320U/1330-BL-QJ

Max. Stroke: 1330 mm
Peak Force: 2180 N

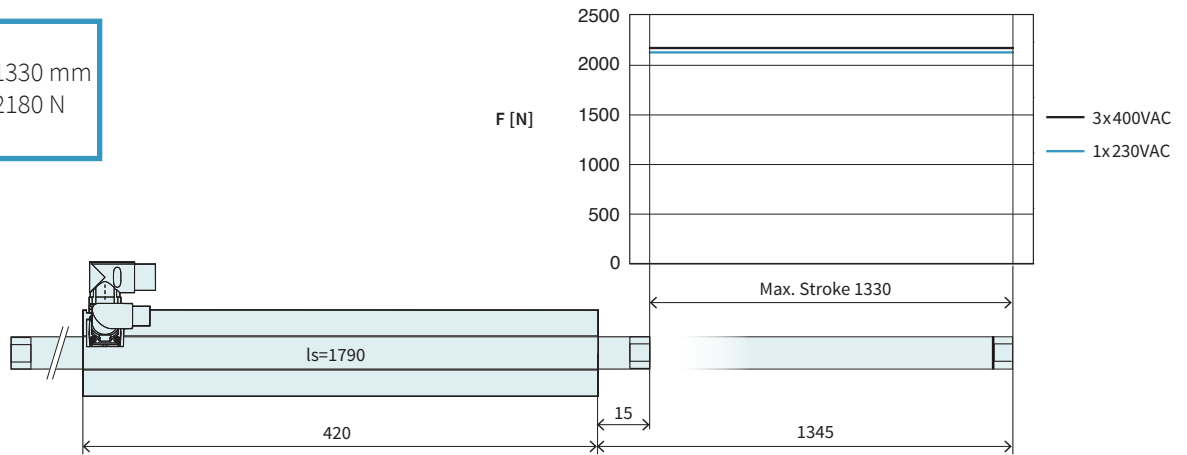

Dimensions in mm

Stroke			
Max. Stroke	mm (in)		1330 (52.39)
Force			
Max. Force ¹ @ 1x230VAC	N (lbf)		2170 (487)
Max. Force ¹ @ 3x400VAC	N (lbf)		2180 (489)
Max. Cont. Force [Passive cooling / Fan / Fluid]	N (lbf)		260 / 400 / 700 (58 / 89 / 160)
Max. Border Force relative	%		100
Force Constant 1	N/A _{pk} (lbf/A _{pk})		64 (14.4)
Force Constant 2	N/A _{rms} (lbf/A _{rms})		90.5 (20.3)
Velocity			
Max. Velocity @ 1x230VAC	m/s (in/s)		2.8 (109.9)
Max. Velocity @ 3x400VAC	m/s (in/s)		4.9 (192.3)
Position Detection			
Repeatability	mm (in)		±0.05 (±0.002)
Linearity	%		± 0.15
Electrical Data			
Max. Current ¹ @ 1x230VAC	A _{pk} / A _{rms}		33.7 / 23.8
Max. Current ¹ @ 3x400VAC	A _{pk} / A _{rms}		33.9 / 23.9
Max. Cont. Current 1 [Passive cooling / Fan / Fluid]	A _{pk}		4.1 / 6.2 / 11
Max. Cont. Current 2 [Passive cooling / Fan / Fluid]	A _{rms}		2.9 / 4.4 / 7.7
Thermal Data			
Max. Winding Temperature (Sensor)	°C		90
Thermal Resistance [Passive cooling / Fan / Fluid]	°K/W		0.65 / 0.28 / 0.09
Thermal Time Constant [Passive cooling / Fan / Fluid]	s		2100 / 500 / 110
Mechanical Data			
Slider Length	mm (in)		1790 (70)
Slider Mass	g (lb)		8413 (18.51)

1) Real time calculation of motor winding temperature is required (including monitoring).
 If temperature monitoring is only based on temperature sensor signal (missing thermal model calculation), 60 % of the peak value has to be taken instead.



Item	Description	Item-No.
PS10-70x320U-BL-QJ	Stator 3x400VAC, LinMot Encoder	0150-1284
PS10-70x320U-BL-QJ-D04	Stator 3x400VAC, Sin/Cos Encoder 1Vpp, Pt1000 dual	0150-4263
PS10-70x320U-BL-QJ-D05	Stator 3x400VAC, Sin/Cos Encoder 1Vpp, PTC dual	0150-4608
PS10-70x320U-BL-QJ-D08	Stator 3x400VAC, Sin/Cos Encoder 1Vpp, KTY dual	0150-4513
PS10-70x320U-BL-QJ-D24	Stator 3x400VAC, A/B Encoder 1µm, Pt1000 dual	0150-4133
PS10-70x320U-BL-QJ-D24S	Stator 3x400VAC, A/B Encoder 5µm, Pt1000 dual	0150-4598
PS10-70x320U-BL-QJ-D25	Stator 3x400VAC, A/B Encoder 1µm, PTC dual	0150-5763
PS10-70x320U-BL-QJ-D25S	Stator 3x400VAC, A/B Encoder 5µm, PTC dual	0150-4603
PS10-70x320U-BL-QJ-D26	Stator 3x400VAC, A/B Encoder 1µm, PTC single ended	0150-4517
PS10-70x320U-BL-QJ-D34	Stator 3x400VAC, BiSS-C, Pt1000 dual	0150-4873
PL10-28x1790/1740	Slider for P10-70 'standard'	0150-2207

P10-70x320U/1530-BL-QJ

Max. Stroke: 1530 mm
Peak Force: 2180 N

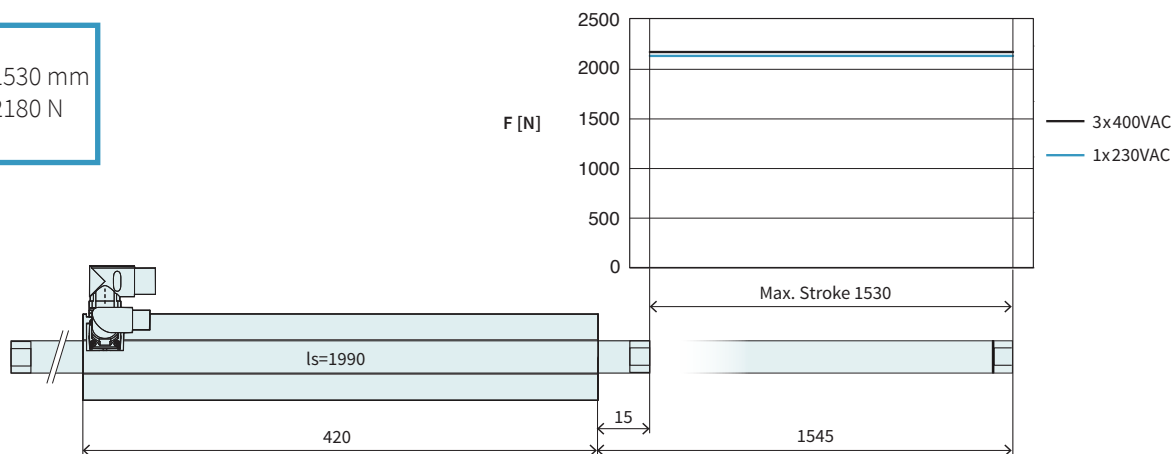

Dimensions in mm

Stroke			
Max. Stroke	mm (in)		1530 (60.2)
Force			
Max. Force ¹ @ 1x230VAC	N (lbf)		2170 (487)
Max. Force ¹ @ 3x400VAC	N (lbf)		2180 (489)
Max. Cont. Force [Passive cooling/ Fan / Fluid]	N (lbf)		260 / 400 / 700 (58 / 89 / 160)
Max. Border Force relative	%		100
Force Constant 1	N/A _{pk} (lbf/A _{pk})		64 (14.4)
Force Constant 2	N/A _{rms} (lbf/A _{rms})		90.5 (20.3)
Velocity			
Max. Velocity @ 1x230VAC	m/s (in/s)		2.8 (109.9)
Max. Velocity @ 3x400VAC	m/s (in/s)		4.9 (192.3)
Position Detection			
Repeatability	mm (in)		±0.05 (±0.002)
Linearity	%		± 0.15
Electrical Data			
Max. Current ¹ @ 1x230VAC	A _{pk} / A _{rms}		33.7 / 23.8
Max. Current ¹ @ 3x400VAC	A _{pk} / A _{rms}		33.9 / 23.9
Max. Cont. Current 1 [Passive cooling / Fan / Fluid]	A _{pk}		4.1 / 6.2 / 11
Max. Cont. Current 2 [Passive cooling / Fan / Fluid]	A _{rms}		2.9 / 4.4 / 7.7
Thermal Data			
Max. Winding Temperature (Sensor)	°C		90
Thermal Resistance [Passive cooling / Fan / Fluid]	°K/W		0.65 / 0.28 / 0.09
Thermal Time Constant [Passive cooling / Fan / Fluid]	s		2100 / 500 / 110
Mechanical Data			
Slider Length	mm (in)		1990 (78)
Slider Mass	g (lb)		9350 (20.57)

1) Real time calculation of motor winding temperature is required (including monitoring).
 If temperature monitoring is only based on temperature sensor signal (missing thermal model calculation), 60 % of the peak value has to be taken instead.



Item	Description	Item-No.
PS10-70x320U-BL-QJ	Stator 3x400VAC, LinMot Encoder	0150-1284
PS10-70x320U-BL-QJ-D04	Stator 3x400VAC, Sin/Cos Encoder 1Vpp, Pt1000 dual	0150-4263
PS10-70x320U-BL-QJ-D05	Stator 3x400VAC, Sin/Cos Encoder 1Vpp, PTC dual	0150-4608
PS10-70x320U-BL-QJ-D08	Stator 3x400VAC, Sin/Cos Encoder 1Vpp, KTY dual	0150-4513
PS10-70x320U-BL-QJ-D24	Stator 3x400VAC, A/B Encoder 1µm, Pt1000 dual	0150-4133
PS10-70x320U-BL-QJ-D24S	Stator 3x400VAC, A/B Encoder 5µm, Pt1000 dual	0150-4598
PS10-70x320U-BL-QJ-D25	Stator 3x400VAC, A/B Encoder 1µm, PTC dual	0150-5763
PS10-70x320U-BL-QJ-D25S	Stator 3x400VAC, A/B Encoder 5µm, PTC dual	0150-4603
PS10-70x320U-BL-QJ-D26	Stator 3x400VAC, A/B Encoder 1µm, PTC single ended	0150-4517
PS10-70x320U-BL-QJ-D34	Stator 3x400VAC, BiSS-C, Pt1000 dual	0150-4873
PL10-28x1990/1940	Slider for P10-70 'standard'	0150-2208

Linear Guides H10



4

HM10-70x320/130 | Linear Module 70x320 with 130 mm Stroke

→	H-Guide	H10-70x320/130	H-Guide for P10-70x320, Stroke max. 130 mm	0150-5414	
	→	Stator	PS10-70x320U-BL-QJ	Stator 3x400VAC, LinMot Encoder	0150-1284
			PS10-70x320U-BL-QJ-D04	Stator 3x400VAC, Sin/Cos Encoder 1Vpp, Pt1000 dual	0150-4263
			PS10-70x320U-BL-QJ-D05	Stator 3x400VAC, Sin/Cos Encoder 1Vpp, PTC dual	0150-4608
			PS10-70x320U-BL-QJ-D08	Stator 3x400VAC, Sin/Cos Encoder 1Vpp, KTY dual	0150-4513
			PS10-70x320U-BL-QJ-D24	Stator 3x400VAC, A/B Encoder 1µm, Pt1000 dual	0150-4133
			PS10-70x320U-BL-QJ-D24S	Stator 3x400VAC, A/B Encoder 5µm, Pt1000 dual	0150-4603
			PS10-70x320U-BL-QJ-D25	Stator 3x400VAC, A/B Encoder 1µm, PTC dual	0150-5763
			PS10-70x320U-BL-QJ-D25S	Stator 3x400VAC, A/B Encoder 5µm, PTC dual	0150-4603
			PS10-70x320U-BL-QJ-D26	Stator 3x400VAC, A/B Encoder 1µm, PTC single ended	0150-4517
	PS10-70x320U-BL-QJ-D34	Stator 3x400VAC, BiSS-C, Pt1000 dual	0150-4873		
→	Slider	PL10-28x590/540	Slider for P10-70 'standard'	0150-2196	

HM10-70x320/230 | Linear Module 70x320 with 230 mm Stroke

→	H-Guide	H10-70x320/230	H-Guide for P10-70x320, Stroke max. 230 mm	0150-5415	
	→	Stator	PS10-70x320U-BL-QJ	Stator 3x400VAC, LinMot Encoder	0150-1284
			PS10-70x320U-BL-QJ-D04	Stator 3x400VAC, Sin/Cos Encoder 1Vpp, Pt1000 dual	0150-4263
			PS10-70x320U-BL-QJ-D05	Stator 3x400VAC, Sin/Cos Encoder 1Vpp, PTC dual	0150-4608
			PS10-70x320U-BL-QJ-D08	Stator 3x400VAC, Sin/Cos Encoder 1Vpp, KTY dual	0150-4513
			PS10-70x320U-BL-QJ-D24	Stator 3x400VAC, A/B Encoder 1µm, Pt1000 dual	0150-4133
			PS10-70x320U-BL-QJ-D24S	Stator 3x400VAC, A/B Encoder 5µm, Pt1000 dual	0150-4603
			PS10-70x320U-BL-QJ-D25	Stator 3x400VAC, A/B Encoder 1µm, PTC dual	0150-5763
			PS10-70x320U-BL-QJ-D25S	Stator 3x400VAC, A/B Encoder 5µm, PTC dual	0150-4603
			PS10-70x320U-BL-QJ-D26	Stator 3x400VAC, A/B Encoder 1µm, PTC single ended	0150-4517
	PS10-70x320U-BL-QJ-D34	Stator 3x400VAC, BiSS-C, Pt1000 dual	0150-4873		
→	Slider	PL10-28x690/640	Slider for P10-70 'standard'	0150-2197	

HM10-70x320/330 | Linear Module 70x320 with 330 mm Stroke

→	H-Guide	H10-70x320/330	H-Guide for P10-70x320, Stroke max. 330 mm	0150-5416	
	→	Stator	PS10-70x320U-BL-QJ	Stator 3x400VAC, LinMot Encoder	0150-1284
			PS10-70x320U-BL-QJ-D04	Stator 3x400VAC, Sin/Cos Encoder 1Vpp, Pt1000 dual	0150-4263
			PS10-70x320U-BL-QJ-D05	Stator 3x400VAC, Sin/Cos Encoder 1Vpp, PTC dual	0150-4608
			PS10-70x320U-BL-QJ-D08	Stator 3x400VAC, Sin/Cos Encoder 1Vpp, KTY dual	0150-4513
			PS10-70x320U-BL-QJ-D24	Stator 3x400VAC, A/B Encoder 1µm, Pt1000 dual	0150-4133
			PS10-70x320U-BL-QJ-D24S	Stator 3x400VAC, A/B Encoder 5µm, Pt1000 dual	0150-4603
			PS10-70x320U-BL-QJ-D25	Stator 3x400VAC, A/B Encoder 1µm, PTC dual	0150-5763
			PS10-70x320U-BL-QJ-D25S	Stator 3x400VAC, A/B Encoder 5µm, PTC dual	0150-4603
			PS10-70x320U-BL-QJ-D26	Stator 3x400VAC, A/B Encoder 1µm, PTC single ended	0150-4517
	PS10-70x320U-BL-QJ-D34	Stator 3x400VAC, BiSS-C, Pt1000 dual	0150-4873		
→	Slider	PL10-28x790/740	Slider for P10-70 'standard'	0150-2198	

4

HM10-70x320/430 | Linear Module 70x320 with 430 mm Stroke

H-Guide	H10-70x320/430	H-Guide for P10-70x320, Stroke max. 430 mm	0150-5417
Stator	PS10-70x320U-BL-QJ	Stator 3x400VAC, LinMot Encoder	0150-1284
	PS10-70x320U-BL-QJ-D04	Stator 3x400VAC, Sin/Cos Encoder 1Vpp, Pt1000 dual	0150-4263
	PS10-70x320U-BL-QJ-D05	Stator 3x400VAC, Sin/Cos Encoder 1Vpp, PTC dual	0150-4608
	PS10-70x320U-BL-QJ-D08	Stator 3x400VAC, Sin/Cos Encoder 1Vpp, KTY dual	0150-4513
	PS10-70x320U-BL-QJ-D24	Stator 3x400VAC, A/B Encoder 1µm, Pt1000 dual	0150-4133
	PS10-70x320U-BL-QJ-D24S	Stator 3x400VAC, A/B Encoder 5µm, Pt1000 dual	0150-4603
	PS10-70x320U-BL-QJ-D25	Stator 3x400VAC, A/B Encoder 1µm, PTC dual	0150-5763
	PS10-70x320U-BL-QJ-D25S	Stator 3x400VAC, A/B Encoder 5µm, PTC dual	0150-4603
	PS10-70x320U-BL-QJ-D26	Stator 3x400VAC, A/B Encoder 1µm, PTC single ended	0150-4517
PS10-70x320U-BL-QJ-D34	Stator 3x400VAC, BiSS-C, Pt1000 dual	0150-4873	
Slider	PL10-28x890/840	Slider for P10-70 'standard'	0150-2199

HM10-70x320/530 | Linear Module 70x320 with 530 mm Stroke

H-Guide	H10-70x320/530	H-Guide for P10-70x320, Stroke max. 530 mm	0150-5418
Stator	PS10-70x320U-BL-QJ	Stator 3x400VAC, LinMot Encoder	0150-1284
	PS10-70x320U-BL-QJ-D04	Stator 3x400VAC, Sin/Cos Encoder 1Vpp, Pt1000 dual	0150-4263
	PS10-70x320U-BL-QJ-D05	Stator 3x400VAC, Sin/Cos Encoder 1Vpp, PTC dual	0150-4608
	PS10-70x320U-BL-QJ-D08	Stator 3x400VAC, Sin/Cos Encoder 1Vpp, KTY dual	0150-4513
	PS10-70x320U-BL-QJ-D24	Stator 3x400VAC, A/B Encoder 1µm, Pt1000 dual	0150-4133
	PS10-70x320U-BL-QJ-D24S	Stator 3x400VAC, A/B Encoder 5µm, Pt1000 dual	0150-4603
	PS10-70x320U-BL-QJ-D25	Stator 3x400VAC, A/B Encoder 1µm, PTC dual	0150-5763
	PS10-70x320U-BL-QJ-D25S	Stator 3x400VAC, A/B Encoder 5µm, PTC dual	0150-4603
	PS10-70x320U-BL-QJ-D26	Stator 3x400VAC, A/B Encoder 1µm, PTC single ended	0150-4517
PS10-70x320U-BL-QJ-D34	Stator 3x400VAC, BiSS-C, Pt1000 dual	0150-4873	
Slider	PL10-28x990/940	Slider for P10-70 'standard'	0150-2203

Accessories

Fan	HV01-37/48	Fan cooling for H01-37/48 & PF02-37/48	0150-5051
-----	------------	--	---------------------------

Motor Cable



C1450



E1400

B Connector MC10-B/m

Q Connector MC10-Q/f

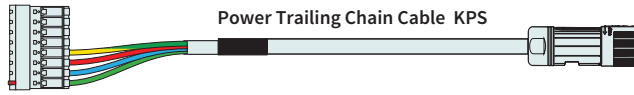

Power Trailing Chain Cable KPS

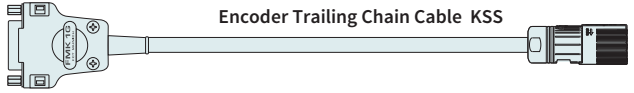

Encoder Trailing Chain Cable KSS



P10-70x320U

D15 Connector MC01-D15/f

J Connector MC10-J/f

L Connector MC10-L/m

Q Connector MC10-Q/f

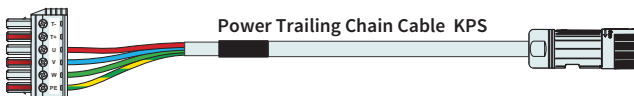

Power Trailing Chain Cable KPS

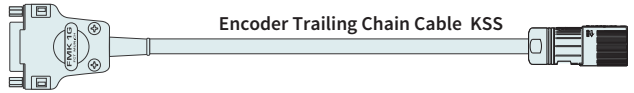

Encoder Trailing Chain Cable KSS



P10-70x320U

D15 Connector MC01-D15/f

J Connector MC10-J/f

ORDERING INFORMATION

POWER CABLES

Item	Description	Item-No.
KPS15-04-L/Q-3	Power Trailing Chain Cable E1400/P10-70, 3 m	0150-2266
KPS15-04-L/Q-5	Power Trailing Chain Cable E1400/P10-70, 5 m	0150-2261
KPS15-04-L/Q-8	Power Trailing Chain Cable E1400/P10-70, 8 m	0150-2267
KPS15-04-L/Q-12	Power Trailing Chain Cable E1400/P10-70, 12 m	0150-2268
KPS15-04-L/Q-	Power Trailing Chain Cable L/Q-, Custom length	0150-3388
KPS15-04-B/Q-3	Power Trailing Chain Cable C1400/P10-70, 3 m	0150-3660
KPS15-04-B/Q-5	Power Trailing Chain Cable C1400/P10-70, 5 m	0150-3661
KPS15-04-B/Q-8	Power Trailing Chain Cable C1400/P10-70, 8 m	0150-3662
KPS15-04-B/Q-12	Power Trailing Chain Cable C1400/P10-70, 12 m	0150-3663
KPS15-04-B/Q-	Power Trailing Chain Cable B/Q-, Custom length	0150-3608

ENCODER CABLES

Item	Description	Item-No.
KSS 05-02/08-D15/J-3	Encoder Trailing Chain Cable D15/J, 3 m	0150-2263
KSS 05-02/08-D15/J-5	Encoder Trailing Chain Cable D15/J, 5 m	0150-2262
KSS 05-02/08-D15/J-8	Encoder Trailing Chain Cable D15/J, 8 m	0150-2264
KSS 05-02/08-D15/J-12	Encoder Trailing Chain Cable D15/J, 12 m	0150-2265
KSS 05-02/08-D15(f)-45°/J-	Encoder Trailing Chain Cable D15/J-, Custom length	0150-3389

EXTENSION CABLES

Item	Description	Item-No.
KPS15-04-Q/Q-	Power Trailing Chain Cable Q/Q-, Custom length	0150-3414
KSS05-02/08-J/J-	Encoder Trailing Chain Cable J/J-, Custom length	0150-3415

CONNECTORS

Item	Description	Item-No.
MC10-L/m	Connector Power E1400/X2	0150-3382
MC01-D15/f	Motor Connector D15 (f)	0150-3136
MC10-Q/f	Connector Power PS10-70	0150-2268
MC10-J/f	Connector Encoder PS10-70	0150-2269

Motor Cables for 3rd Party Drives

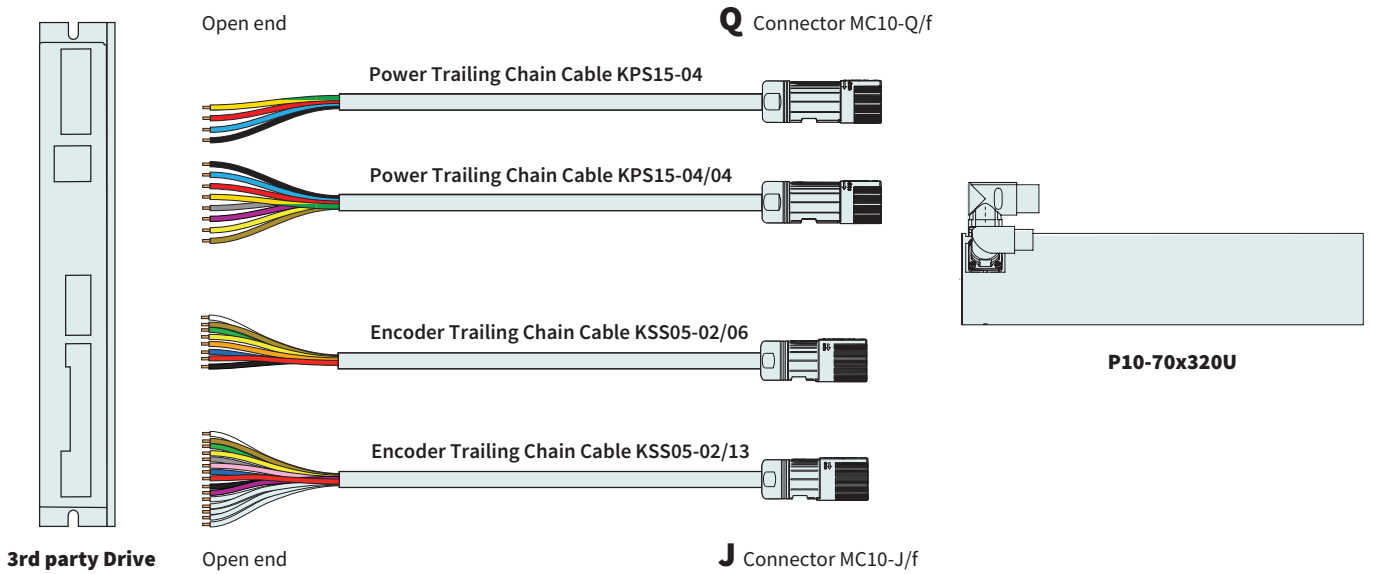

ORDER OVERVIEW							
Motor-Interface	Power Cable		Encoder Cable				
		TempFeedback		TempFeedback	Hallswitch Signals	Reference Signal	PosFeedback
D04 / D05 / D08	KPS15-04-_/Q-...	---	KSS05-02/13-_/J-...	Pt1000 / PTC / KTY	Hall U/V/W	Ref	Sin/Cos
	KPS15-04/04-_/Q-...	Pt1000 / PTC / KTY	KSS05-02/06-_/J-...	---	---	---	
D24(S) / D25(S) / D26	KPS15-04-_/Q-...	---	KSS05-02/13-_/J-...	Pt1000 / PTC	Hall U/V/W	Ref	AB 1 µm (5 µm)
	KPS15-04/04-_/Q-...	Pt1000 / PTC	KSS05-02/06-_/J-...	---	---	---	
D34	KPS15-04-_/Q-...	---	KSS05-02/13-_/J-...	Pt1000	Hall U/V/W	Ref	BiSS-C
	KPS15-04/04-_/Q-...	Pt1000					

ORDERING INFORMATION

POWER CABLES

Item	Description	Item-No.
KPS15-04-.../Q-10	Power Trailing Chain Cable .../Q, 10 m for Dxx	0150-2376
KPS15-04-./Q-	Power Trailing Chain Cable .../Q, für Dxx, Custom length	0150-3491
KPS15-04	Power Trailing Chain Cable P10-70 (per m)	0150-2257
KPS15-04/04.../Q-10	Power Trailing Chain Cable .../Q, 10 m for Dxx	0150-3654
KPS15-04/04-./Q-	Power Trailing Chain Cable .../Q, für Dxx, Custom length	0150-3579
KPS15-04/04	Power Trailing Chain Cable P10-...-Dxx (per m)	0150-2269

ENCODER CABLES

Item	Description	Item-No.
KSS05-02/13-.../J-10	Encoder Trailing Chain Cable .../J, 10 m for Dxx	0150-2377
KSS05-02/13-./J-	Encoder Trailing Chain Cable ./J, für Dxx, Custom length	0150-3492
KSS05-02/13	Encoder Trailing Chain Cable P10-...-Dxx (per m)	0150-2259

EXTENSION CABLES

Item	Description	Item-No.
KPS15-04-Q/Q-	Power Trailing Chain Cable Q/Q-, Custom length	0150-3414
KPS15-04/04-Q/Q-	Power Trailing Chain Cable Q/Q-, Custom length	0150-4214
KSS05-02/13-J/J-	Encoder Trailing Chain Cable J/J, für Dxx, Custom length	0150-3996

CONNECTORS

Item	Description	Item-No.
MC10-Q/f	Connector Power PS10-70	0150-2268
MC10-J/f	Connector Encoder PS10-70	0150-2269

MOTOR FLANGES



Item	Description	Item-No.
PF10-70x350	Flange for PS10-70x320	0150-2290



Item	Description	Item-No.
PF11-70x350-FC	Flange for PS10-70x320 fluid cooling	0150-2825

FIND MORE PRODUCT DETAILS IN THE CHAPTER "ACCESSORIES".

FANS



Item	Description	Item-No.
HV01-37/48	Fan cooling for H01-37/48 & PF02-37/48	0150-5051

FIND MORE PRODUCT DETAILS IN THE CHAPTER "ACCESSORIES".

SLIDER MOUNTING



Item	Description	Item-No.
PLF01-28	Fixed Bearing Set for 27/28 mm sliders	0150-3087
PLF01-28-SS	Fixed Bearing Set for 27/28 mm sliders, stainless steel	0150-3297
PLL01-28	Floating Bearing for 28 mm sliders	0150-3094
PLM01-28-MK	Mounting Kit for 28 mm sliders	0150-3095

FIND MORE PRODUCT DETAILS IN THE CHAPTER "ACCESSORIES".

BEARING KIT



Item	Description	Item-No.
PB10-70x320-L	Bearing Kit for PS10-70x320	0150-3434

FIND MORE PRODUCT DETAILS IN THE CHAPTER "ACCESSORIES".

LUBRICANT RESERVOIR



Item	Description	Item-No.
PA10-70/28	Lubricant reservoir for PS10-70 with lubricating nipple	0150-3543

FIND MORE PRODUCT DETAILS IN THE CHAPTER "ACCESSORIES".

EXTERNAL POSITION SENSORS

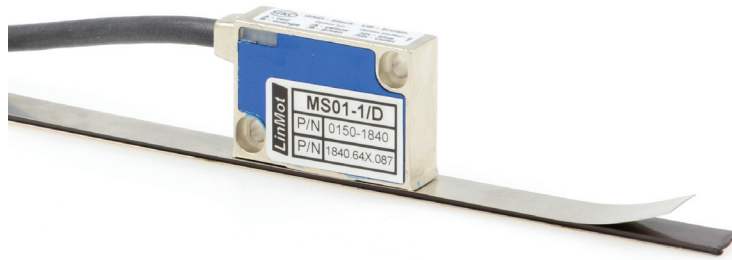

Item	Description	Item-No.
MS01-1/D	Linear Encoder 1µm, A/B (for incremental strip)	0150-1840
MB01-1000	Magnetic incremental strip for MS01-1/D, per cm	0150-1963
KS025-D15/D-Encoder	Encoder Cable (Length in m)	0150-3168

FIND MORE PRODUCT DETAILS IN THE CHAPTER "ACCESSORIES".



Item	Description	Item-No.
MS01-1/D-SSI	Linear Encoder 1µm, A/B (for absolute strip)	0150-2095
MB01-1000-ABS	Magnetic absolute strip for MS01-1/D-SSI (per cm)	0150-2096
EC01-ABS/ENC-12-S	MS01-1/D-SSI Encoder connector straight	0150-3616
KSS01-12-D15/ABS-ENC	Special cable for MS01-1/D-SSI on C1100/C1200/C1400/E1200/E1400 Drives	0150-3652

FIND MORE PRODUCT DETAILS IN THE CHAPTER "ACCESSORIES".