

# LINEAR MOTORS P10-70X240U

4



- ✓ 3 x 400VAC technology
- ✓ Peak forces up to 1650 N
- ✓ LinMot encoder or 3rd party drive encoder  
BiSS-C, SinCos, AB incremental / Pt 1000, KTY, PTC
- ✓ Extremely high dynamic
- ✓ Separate connector for sensor and power cable
- ✓ Can also be controlled by standard third-party servo drives

## LINEAR MOTORS P10-70X240U

<b>/ TECHNICAL DATA /</b> .....	<b>562</b>
<b>/ MOTOR SPECIFICATIONS /</b> .....	<b>576</b>
P10-70x240U/10-BL-QJ.....	576
P10-70x240U/110-BL-QJ.....	577
P10-70x240U/210-BL-QJ.....	578
P10-70x240U/310-BL-QJ.....	579
P10-70x240U/410-BL-QJ.....	580
P10-70x240U/510-BL-QJ.....	581
P10-70x240U/610-BL-QJ.....	582
P10-70x240U/810-BL-QJ.....	583
P10-70x240U/1010-BL-QJ .....	584
P10-70x240U/1210-BL-QJ .....	585
P10-70x240U/1410-BL-QJ .....	586
P10-70x240U/1610-BL-QJ .....	587
<b>/ LINEAR GUIDES /</b> .....	<b>588</b>
<b>/ ACCESSORIES /</b> .....	<b>590</b>



## MOTOR FAMILY P10-70x240U

### Technical Data

Stroke				
Max. Stroke (ES)	mm	(in)	1610	(63.39)
Force				
Max. Force <sup>1</sup> @ 1x230VAC	N	(lbf)	1650	(371)
Max. Force <sup>1</sup> @ 3x400VAC	N	(lbf)	1650	(371)
Max. Cont. Force [Passive cooling / Fan / Fluid]	N	(lbf)	190 / 290 / 510	(43 / 66 / 120)
Max. Border Force relative	%		100	
Force Constant 1	N/A <sub>pk</sub>	(lbf/A <sub>pk</sub> )	59	(13.3)
Force Constant 2	N/A <sub>rms</sub>	(lbf/A <sub>rms</sub> )	83.4	(18.8)
Velocity				
Max. Velocity @ 1x230VAC	m/s	(in/s)	3	(119.9)
Max. Velocity @ 3x400VAC	m/s	(in/s)	5.4	(209.9)
Position Detection				
Position Resolution	mm	(in)	0.005	(0.0002)
Repeatability	mm	(in)	±0.05	(±0.002)
Position Resolution with ES	mm	(in)	0.001	(0.00004)
Repeatability with ES	mm	(in)	±0.01	(±0.0004)
Linearity with ES	mm	(in)	±0.01	(±0.0004)
Electrical Data				
Max. Current <sup>1</sup> @ 1x230VAC	A <sub>pk</sub> / A <sub>rms</sub>		27.9 / 19.7	
Max. Current <sup>1</sup> @ 3x400VAC	A <sub>pk</sub> / A <sub>rms</sub>		27.9 / 19.7	
Max. Cont. Current 1 [Passive cooling / Fan / Fluid]	A <sub>pk</sub>		3.3 / 5 / 8.7	
Max. Cont. Current 2 [Passive cooling / Fan / Fluid]	A <sub>rms</sub>		2.3 / 3.5 / 6.1	
Back EMF Constant	V <sub>pk</sub> / (m/s)	(V <sub>pk</sub> / (in/s))	68.1	(1.73)
Terminal Resistance 25 °C / 120 °C	Ohm		6.3 / 8.6	
Terminal Inductivity	mH		12	
Magnetic Period	mm	(in)	40	(1.57)
Thermal Data				
Max. Winding Temperature (Sensor)	°C		90	
Thermal Resistance [Passive cooling / Fan / Fluid]	°K/W		0.87 / 0.38 / 0.12	
Thermal Time Constant [Passive cooling / Fan / Fluid]	s		2100 / 510 / 110	
Mechanical Data				
Stator Diameter	mm	(in)	70	(2.8)
Stator Length	mm	(in)	340	(13)
Stator Mass	g	(lb)	5550	(12.21)
Slider Diameter	mm	(in)	28	(1.1)
Slider Length	mm	(in)	390 - 1990	(15 - 78)
Slider Mass	g	(lb)	1830 - 9350	(4.03 - 20.57)
IP Code			IP 65	
Certification				
UL	File-No.		E354430	

1) Real time calculation of motor winding temperature is required (including monitoring).

If temperature monitoring is only based on temperature sensor signal (missing thermal model calculation), 60 % of the peak value has to be taken instead.

**STATOR**

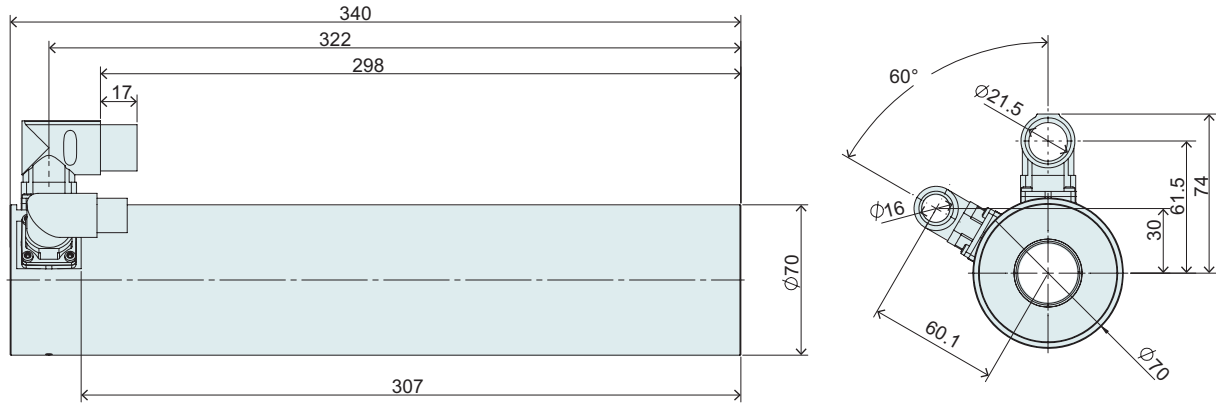

Item	Description	Item-No.	Comment
<b>PS10-70x240U-BL-QJ</b>	Stator 3x400VAC, LinMot Encoder	<a href="#">0150-1293</a>	For use with LinMot Drives
<b>PS10-70x240U-BL-QJ-D04</b>	Stator 3x400VAC, Sin/Cos Encoder 1Vpp, Pt1000 dual	<a href="#">0150-4262</a>	For use with 3rd Party Drives
<b>PS10-70x240U-BL-QJ-D05</b>	Stator 3x400VAC, Sin/Cos Encoder 1Vpp, PTC dual	<a href="#">0150-4607</a>	For use with 3rd Party Drives
<b>PS10-70x240U-BL-QJ-D08</b>	Stator 3x400VAC, Sin/Cos Encoder 1Vpp, KTY dual	<a href="#">0150-4512</a>	For use with 3rd Party Drives
<b>PS10-70x240U-BL-QJ-D24</b>	Stator 3x400VAC, A/B Encoder 1µm, Pt1000 dual	<a href="#">0150-4132</a>	For use with 3rd Party Drives
<b>PS10-70x240U-BL-QJ-D24S</b>	Stator 3x400VAC, A/B Encoder 5µm, Pt1000 dual	<a href="#">0150-4597</a>	For use with 3rd Party Drives
<b>PS10-70x240U-BL-QJ-D25</b>	Stator 3x400VAC, A/B Encoder 1µm, PTC dual	<a href="#">0150-5762</a>	For use with 3rd Party Drives
<b>PS10-70x240U-BL-QJ-D25S</b>	Stator 3x400VAC, A/B Encoder 5µm, PTC dual	<a href="#">0150-4602</a>	For use with 3rd Party Drives
<b>PS10-70x240U-BL-QJ-D26</b>	Stator 3x400VAC, A/B Encoder 1µm, PTC single ended	<a href="#">0150-4516</a>	For use with 3rd Party Drives
<b>PS10-70x240U-BL-QJ-D34</b>	Stator 3x400VAC, BiSS-C, Pt1000 dual	<a href="#">0150-4872</a>	For use with 3rd Party Drives

**AVAILABLE INTERFACES FOR 3RD PARTY DRIVES**

TEMPERATURE FEEDBACK		POSITION FEEDBACK			
		SinCos, 1Vpp	A/B 1µm	A/B 5µm	BiSS-C
Pt1000, dual*	Dx4	D0x	D2x	D2xS	D3x
PTC, dual*	Dx5	<b>D05</b>	<b>D25</b>	<b>D25S</b>	
PTC single ended	Dx6		<b>D26</b>		
KTY, dual*	Dx8	<b>D08</b>			

\* Feedback available on encoder and power connectors.

**CONNECTOR PS10-70x240U-BL-QJ (INTERFACE FOR LINMOT DRIVES)**

Motor Connector Wiring		Connector Encoder J	Wire Color Cable KSS05-02/08
+5VDC*	Supply	1	red
GND	Supply	2	black
Sense +5V*	Supply Sense	3	white
Sense GND*	Supply Sense	4	brown
Mot. Link C+	Communication	5	pink
Mot. Link C-	Communication	6	grey
Sin+	Encoder	7	yellow
Sin-	Encoder	8	orange
Cos+	Encoder	9	green
Cos-	Encoder	10	blue
n. c.	n. c.	11	n. c.
n. c.	n. c.	12	n. c.
n. c.	n. c.	13	n. c.
n. c.	n. c.	14	n. c.
n. c.	n. c.	15	n. c.
n. c.	n. c.	16	n. c.
n. c.	n. c.	17	n. c.

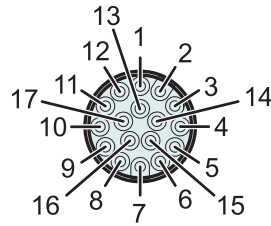

**Connector Encoder J**

View: Motor connector, plug side

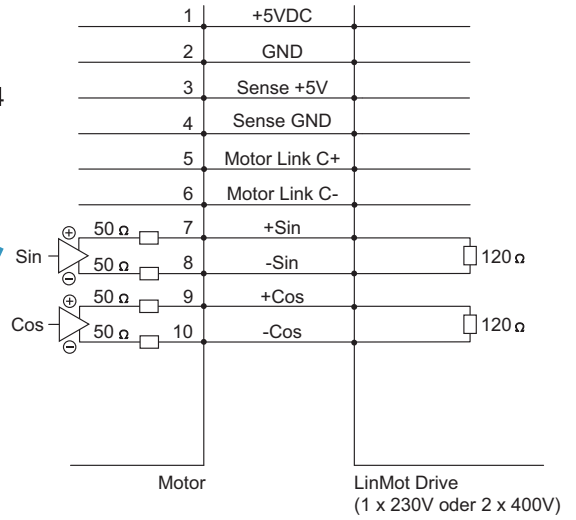

\* The supply voltage at 5V sense supply is approx. 6V. Newer motors are provided with a modified power supply, that does not require sense lines any more. In that case, a supply voltage of 6...9V is permitted.

Motor Connector Wiring	Connector Power Q	Wire Color Cable KPS15-04
Phase U	1	red
PE	2	yellow-green
Phase W	3	black (previously: green)
Phase V	4	blue
n. c.	A	n. c.
n. c.	B	n. c.
n. c.	C	n. c.
n. c.	D	n. c.

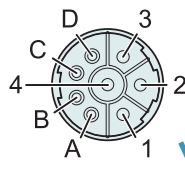

**Connector Power Q**

View: Motor connector, plug side

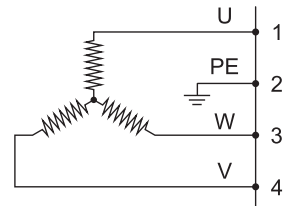

**SIN/COS-POSITIONS-FEEDBACK (D0X-INTERFACE FOR 3RD PARTY DRIVES)**

The linear motors of the P10-70 series have a contactless, integrated position feedback, which means that an external encoder is not required. The integrated position sensor technology of the motors with D0x interface provides a differential standard 1Vpp sin/cos signal with a 40mm period. The phase position of the sensor signals and the phase currents (with constant force in positive direction) is shown on the right side of the diagram. (The SIN encoder signal is in phase with the current characteristic of phase U).

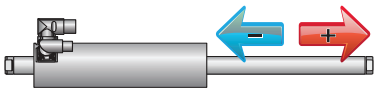

The arrows show the direction of movement of the slider. The stator remains in its position.

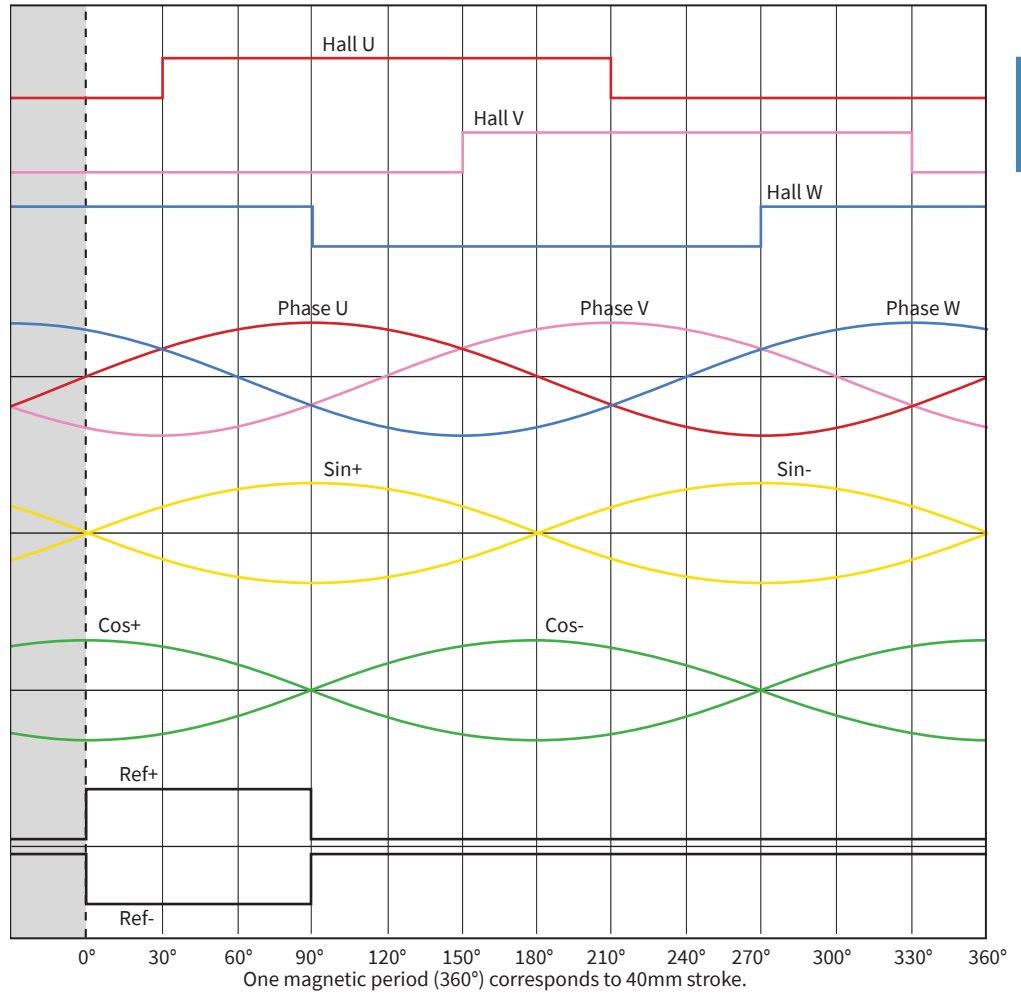

Sin / Cos		P10-70x...-D0x
Output signal period	mm	40
Signal amplitude <sup>1</sup>	V <sub>pp</sub>	1
Termination <sup>1</sup>	Ohm	120
Supply voltage	Vdc	3...13 (w or w/o sense)
Power consumption	mW	< 1000
		(I < 150mA @ 5VDC, I < 80mA @ 12 VDC) <sup>2</sup>

1) Applicable for Sin+/Sin-, Cos+/Cos- and Ref+/Ref- signals. Hall U/V/W are open collector signals.  
 2) Power efficiency of the motor electronics varies with supply voltage

**CONNECTOR PS10-70X240U-BL-QJ-D04/05/08 (SIN/COS-INTERFACE FOR 3RD PARTY DRIVES)**

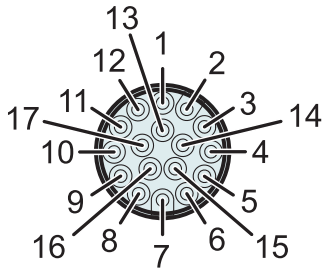

3 ... 13VDC  
(I<sub>max</sub> < 150mA @ 5VDC)  
(I<sub>max</sub> < 80mA @ 12VDC)

**Connector Encoder J**

View: Motor connector, plug side

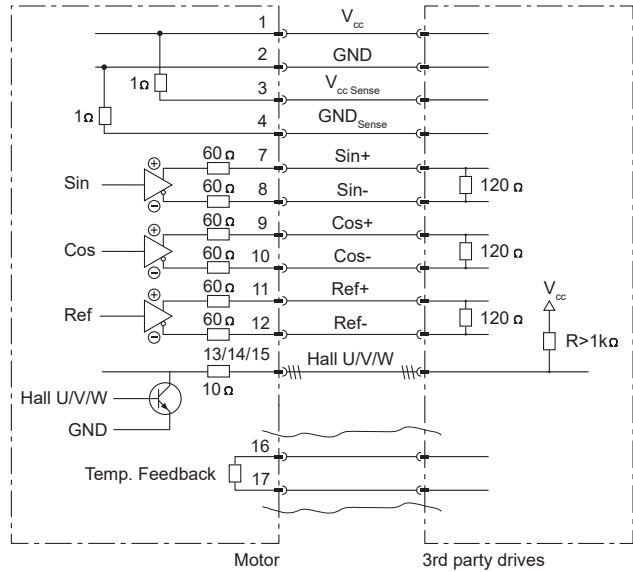

**PS10-70X240U-BL-QJ-D04**

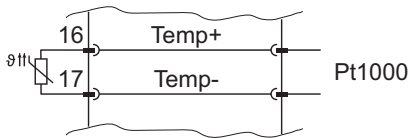

**PS10-70X240U-BL-QJ-D05**

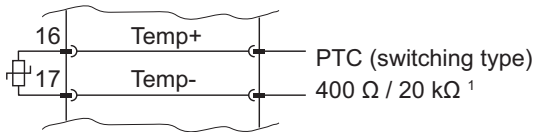

**PS10-70X240U-BL-QJ-D08**

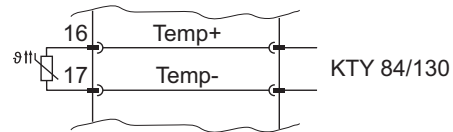

1) ≤ 400 Ω = no error, ≥ 20 kΩ = error

Sin/Cos-Interface: Encoder Connector Wiring

PS10-70x240U-BL-QJ-D04	PS10-70x240U-BL-QJ-D05	PS10-70x240U-BL-QJ-D08	Connector Encoder J	Wire Color Motor Cable KSS05-02/06	Wire Color Motor Cable KSS05-02/13
	3 ... 13VDC		1	red	white
	GND		2	black	brown
	Vcc Sense (optional)		3	white	green
	GND Sense (optional)		4	brown	yellow
	Do not connect		5	-	-
	Do not connect		6	-	-
	Sin+		7	yellow	grey
	Sin-		8	orange	pink
	Cos+		9	green	blue
	Cos-		10	blue	red
	Ref+		11	-	black
	Ref-		12	-	purple
	Hall U		13	-	grey-red
	Hall V		14	-	red-blue
	Hall W		15	-	white-green
Temp+ (Pt1000 Char.) <sup>2)</sup>	Temp+ (PTC 400/20k Char.) <sup>2)</sup>	Temp+ (KTY84/130 Char.) <sup>2)</sup>	16	-	yellow-brown
Temp- (Pt1000 Char.) <sup>2)</sup>	Temp- (PTC 400/20k Char.) <sup>2)</sup>	Temp- (KTY84/130 Char.) <sup>2)</sup>	17	-	white-yellow

2) The temperature evaluation circuit must have the same galvanic reference potential as the encoder circuit (supply). It should therefore be connected to the supply GND. For correct evaluation, the connection potentials of the emulated temperature sensor must be in the range of the supply potentials. Valid temperature values can only be measured 50ms after the encoder supply is applied. In the currentless state, a resistance of 200kOhm is measured between pin 16 and 17 is measured. The maximum voltage between pin 16 and 17 must not exceed 16VDC. The maximum current is 15mA.

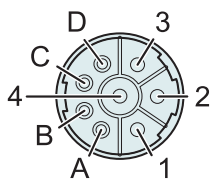

**Connector Power Q**

View: Motor connector, plug side

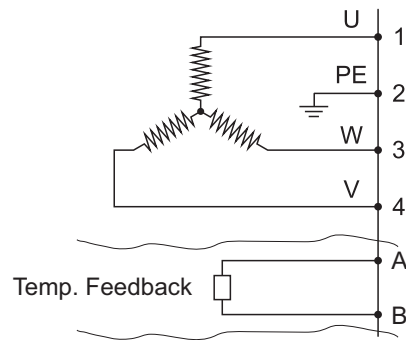

**PS10-70X240U-BL-QJ-D04**

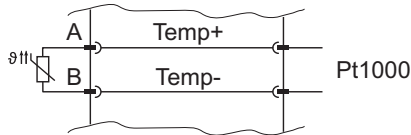

**PS10-70X240U-BL-QJ-D05**

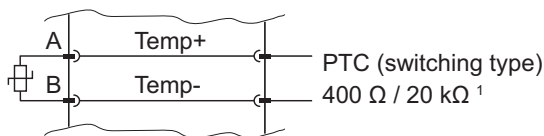

**PS10-70X240U-BL-QJ-D08**

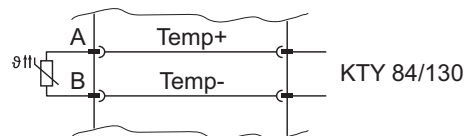

1)  $\leq 400 \Omega$  = no error,  $\geq 20 \text{ k}\Omega$  = error

Sin/Cos-Interface: Power Connector Wiring					
PS10-70x240U-BL-QJ-D04	PS10-70x240U-BL-QJ-D05	PS10-70x240U-BL-QJ-D08	Connector Power Q	Wire Color Motor Cable KPS15-04	Wire Color Motor Cable KPS15-04/04
Phase U			1	red	red
PE			2	yellow-green	yellow-green
Phase W			3	black	black
Phase V			4	blue	blue
Temp+ (Pt1000) <sup>2)</sup>	Temp+ (PTC) <sup>2)</sup>	Temp+ (KTY84/130 Char.) <sup>2)</sup>	A	n. c.	purple
Temp- (Pt1000) <sup>2)</sup>	Temp- (PTC) <sup>2)</sup>	Temp- (KTY84/130 Char.) <sup>2)</sup>	B	n. c.	grey
n. c.	n. c.	n. c.	C	n. c.	yellow
n. c.	n. c.	n. c.	D	n. c.	brown

2) The temperature evaluation circuit must have the same galvanic reference potential as the encoder circuit (supply). It should therefore be connected to the supply GND. For correct evaluation, the connection potentials of the emulated temperature sensor must be in the range of the supply potentials. Valid temperature values can only be measured 50ms after the encoder supply is applied. In currentless state a resistance of 200kOhm is measured between pin A and B. The maximum voltage between pin A and B must not exceed 16VDC. The maximum current is 15mA.

**TEMPERATURE FEEDBACK D04 / D05 / D08**

Overheating protection is provided by three internal thermistors embedded in the motor windings. These thermistors are monitored by the motor electronics. A single thermistor is simulated based on the maximum temperature readings. This is done in order to accurately monitor the temperature over the entire length of the stator and to respond as quickly as possible to dynamic changes in a single motor phase. When the temperature of the motor winding reaches its absolute maximum value, the drive amplifier/servo controller must switch off the motor to protect it from overheating damage. Various temperature interfaces – Dx4, Dx5 or Dx8 – are available to support

the temperature evaluation provided by the drive amplifier/servo controller. Depending on the interface and signals used, there are suitable motor cables (see overview table in the Accessories/Motor Cables section).

**D04 (Pt1000 dual)**

Both the **signal** and **power connectors** feature an emulated **Pt1000 thermistor** for evaluating the maximum motor temperature.

**D05 (PTC dual)**

Both the **signal** and **power connectors** are fitted with an emulated **PTC thermistor** that switches to high-impedance mode when the maximum motor temperature is exceeded.

**D08 (KTY 84/130 dual)**

Both the **signal** and **power connectors** feature an emulated **KTY thermistor**, which is used to evaluate the maximum motor temperature.

**A/B INCREMENTAL POSITION FEEDBACK (D2X- INTERFACE FOR 3RD PARTY DRIVES)**

The linear motors of the P10-70 series have a contactless, integrated position feedback, which means that an external encoder is not required.

The position output of the motors with D2x interface is an industry-standard A/B incremental signal with supplementary reference signal (RS422). Hall switch signals are available for commutation. The relationship between the phase current and the position sensor output is shown on the right.

4

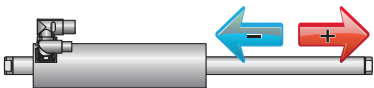

The arrows show the direction of movement of the slider. The stator remains in its position.

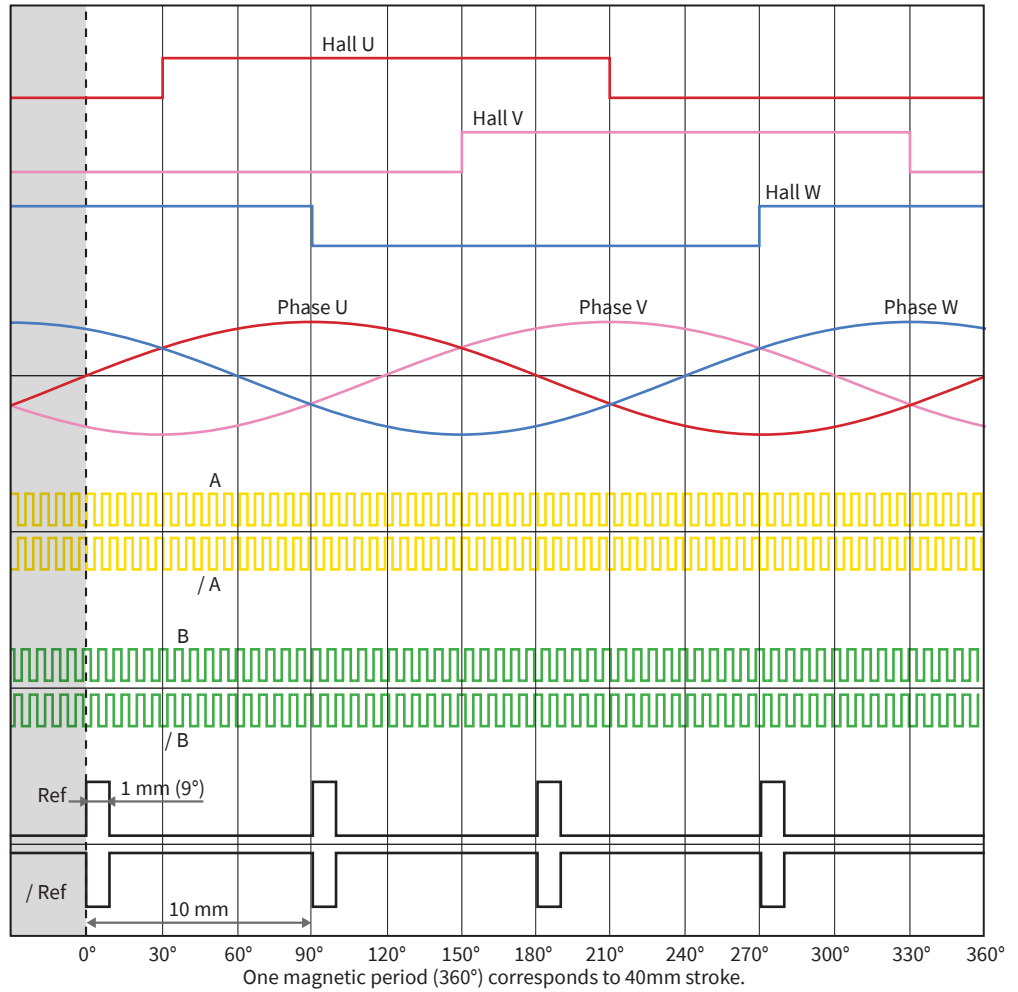

Example:

Min. pulse interval  $t = 500 \text{ ns}$

For downstream evaluation, at least the following counter frequency is required:

$$f_{\text{counter}} = 1 / \text{pulse interval} = 1 / 500 \text{ ns} = 2 \text{ MHz}$$



The logical state of signals A and B is not defined in relation to the reference signal Ref. The signal shape may differ from the illustration.

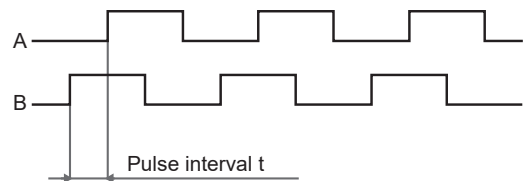

A / B		P10-70x...-D2x	P10-70x...-D2xS
Position Resolution	$\mu\text{m}$	1	5
Output Type		RS422	
Min. Edge Distance $t$	ns	100	500
Min. required counter frequency	MHz	10	2
Supply Voltage	Vdc	5-12	
Max. Supply Current	mA	300	300

**CONNECTOR PS10-70X240U-BL-QJ-D24 / 24S / 25 / 25S / 26 (A/B-INTERFACE FOR 3RD PARTY DRIVES)**

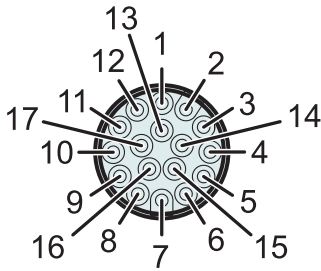

3 ... 13VDC  
 (Imax < 150mA @ 5VDC)  
 (Imax < 80mA @ 12VDC)

**Connector Encoder J**

View: Motor connector, plug side

**PS10-70X240U-BL-QJ-D24 / D24S**

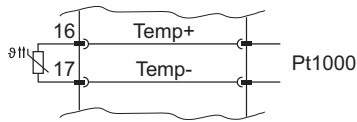

**PS10-70X240U-BL-QJ-D25 / D25S**

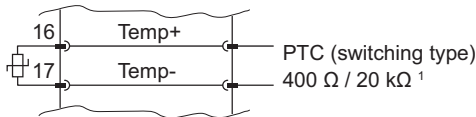

1) ≤ 400 Ω = no error, ≥ 20 kΩ = error

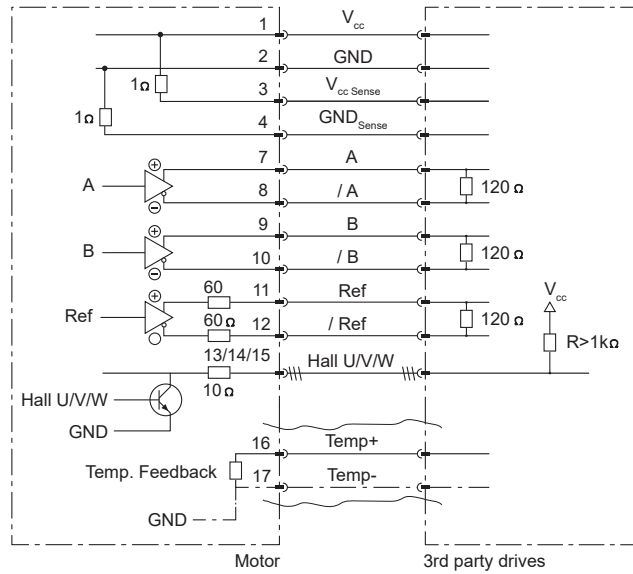

**PS10-70X240U-BL-QJ-D26**

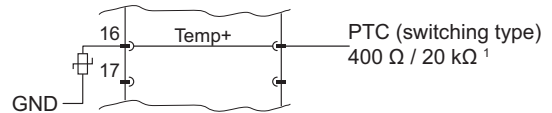

A/B-Interface: Encoder Connector Wiring						
PS10-70x240U-BL-QJ-D24 PS10-70x240U-BL-QJ-D24S	PS10-70x240U-BL-QJ-D25 PS10-70x240U-BL-QJ-D25S	PS10-70x240U-BL-QJ-D26	Connector Encoder J	Wire Color Motor Cable KSS05-02/06	Wire Color Motor Cable KSS05-02/13	
	3 ... 13 VDC		1	red	white	
	GND		2	black	brown	
	Vcc Sense (optional)		3	white	green	
	GND Sense (optional)		4	brown	yellow	
	Do not connect		5	-	-	
	Do not connect		6	-	-	
	A		7	yellow	grey	
	/A		8	orange	pink	
	B		9	green	blue	
	/B		10	blue	red	
	Ref		11	-	black	
	/Ref		12	-	purple	
	Hall U		13	-	grey-red	
	Hall V		14	-	red-blue	
	Hall W		15	-	white-green	
Temp+ (Pt1000 Char.) <sup>2)</sup>	Temp+ (PTC 400/20k Char.) <sup>2)</sup>	Temp+ (PTC 400/20k Char.) <sup>2)</sup>	16	-	yellow-brown	
Temp- (Pt1000 Char.) <sup>2)</sup>	Temp- (PTC 400/20k Char.) <sup>2)</sup>	Do not connect	17	-	white-yellow	

2) The temperature evaluation circuit must have the same galvanic reference potential as the encoder circuit (supply). It should therefore be connected to the supply GND. For correct evaluation, the connection potentials of the emulated temperature sensor must be in the range of the supply potentials. Valid temperature values can only be measured 50ms after the encoder supply is applied. In the currentless state, a resistance of 200kOhm is measured between pin 16 and 17 is measured. The maximum voltage between pin 16 and 17 must not exceed 16VDC. The maximum current is 15mA.

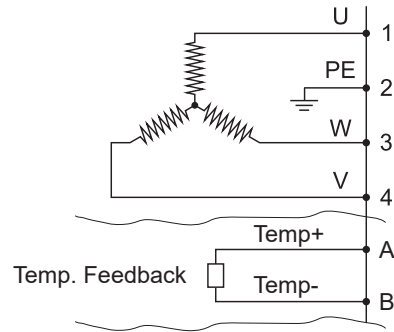
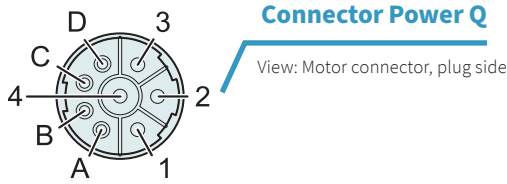

**PS10-70X240U-BL-QJ-D24 / D24S**

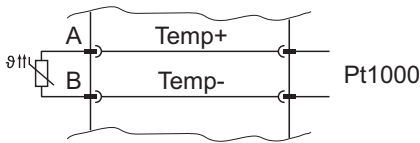

**PS10-70X240U-BL-QJ-D25 / D25S**

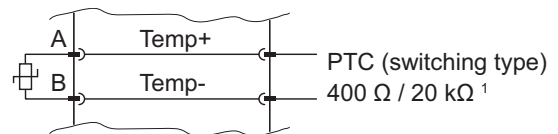

1) unter 400 Ω = no error, über 20 kΩ = error

A/B-Interface: Power Connector Wiring					
PS10-70x240U-BL-QJ-D24 PS10-70x240U-BL-QJ-D24S	PS10-70x240U-BL-QJ-D25 PS10-70x240U-BL-QJ-D25S	PS10-70x240U-BL-QJ-D26	Connector Power Q	Wire Color Motor Cable KPS15-04	Wire Color Motor Cable KPS15-04/04
Phase U			1	red	red
PE			2	yellow-green	yellow-green
Phase W			3	black	black
Phase V			4	blue	blue
Temp+ (Pt1000) <sup>2)</sup>	Temp+ (PTC) <sup>2)</sup>	n. c.	A	n. c.	purple
Temp- (Pt1000) <sup>2)</sup>	Temp- (PTC) <sup>2)</sup>	n. c.	B	n. c.	grey
n. c.	n. c.	n. c.	C	n. c.	yellow
n. c.	n. c.	n. c.	D	n. c.	brown

2) The temperature evaluation circuit must have the same galvanic reference potential as the encoder circuit (supply). It should therefore be connected to the supply GND. For correct evaluation, the connection potentials of the emulated temperature sensor must be in the range of the supply potentials. Valid temperature values can only be measured 50ms after the encoder supply is applied. In currentless state a resistance of 200kOhm is measured between pin A and B. The maximum voltage between pin A and B must not exceed 16VDC. The maximum current is 15mA.

**TEMPERATURE FEEDBACK D24 / D24S / D25 / D25S / D26**

Overheating protection is provided by three internal thermistors embedded in the motor windings. These thermistors are monitored by the motor electronics. A single thermistor is simulated based on the maximum temperature readings. This is done in order to accurately monitor the temperature over the entire length of the stator and to respond as quickly as possible to dynamic changes in a single motor phase. If the temperature of the motor winding reaches its absolute maximum value, the drive amplifier/servo controller must switch off the motor to protect it from overheating damage. Various temperature interfaces – DX4, DX5 or DX6 – are available to support the temperature evaluation provided by the

drive amplifier/servo controller. Depending on the interface and signals used, there are suitable motor cables (see overview table in the Accessories/Motor Cables section).

**D24 / D24S (Pt1000 dual)**

An emulated **Pt1000 thermistor** is available on both the **signal** and **power connectors** for evaluating the maximum motor temperature.

**D25 / D25S (PTC dual)**

An emulated **PTC thermistor** is available on both the **signal** and **power connectors**, which switches to a high-impedance state when the maximum motor temperature is exceeded.

**D26 (PTC)**

An emulated PTC thermistor is available on the **signal connector**, which switches to a high-impedance state when the maximum motor temperature is exceeded. The emulated **PTC** is internally **connected to GND on one side**, which is why only an additional signal line is connected to the servo controller for evaluation in addition to the power supply.

**BISS-C POSITION FEEDBACK (D3X- INTERFACE FOR 3RD PARTY DRIVES)**

The linear motors of the P10-70 series have contactless, integrated position feedback, which means that there is no need for an external encoder.

The position feedback of the motors with D3x interface is based on RS422 and the industry-standard BiSS-C protocol. Either the transmitted position or the hall switch signals can be used for commutation. The relationship between the phase current and the encoder signals is shown on the right.

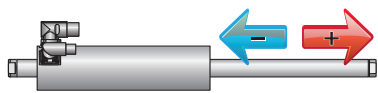

The arrows show the direction of movement of the slider. The stator remains in its position.

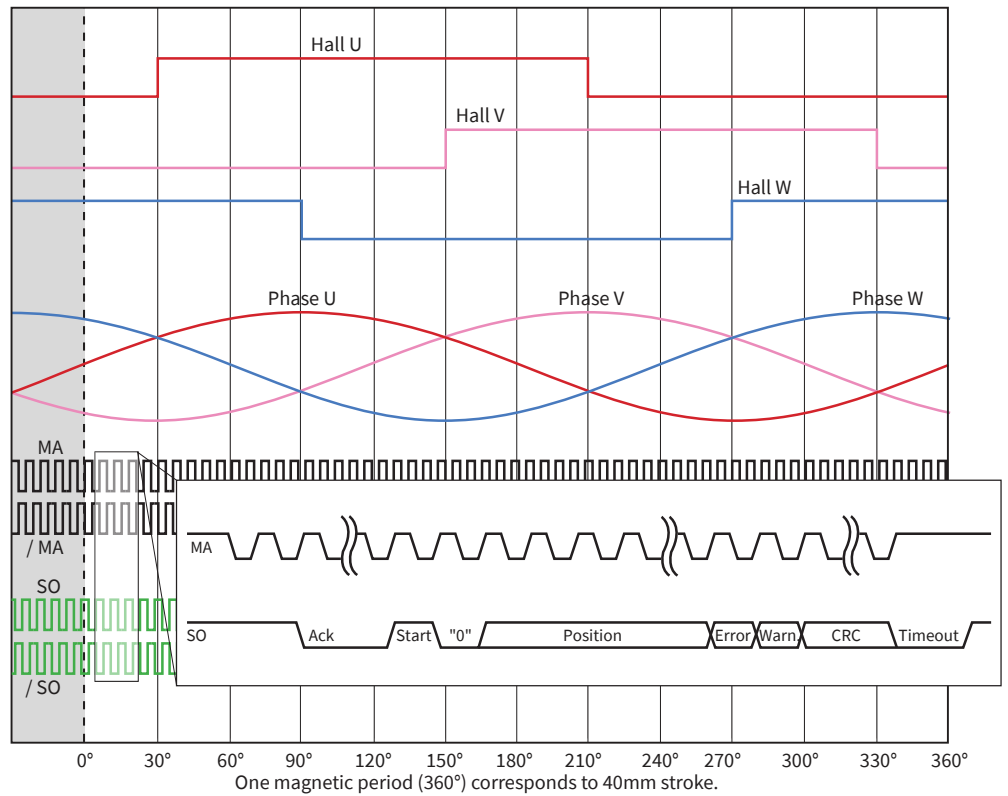

BiSS-C <sup>1)</sup>	P10-70x...-D3x			
Singleturn Position Resolution	µm	1		
Output Type		RS422		
MA Clock frequency	MHz	1...3.3		
Max. request cycle rate <sup>2)</sup>	kHz	16		
Supply Voltage	Vdc	5 -12		
Max. Supply Current	mA	300		
Data Type		SCDS (Single Cycle Data Sensor)		
Data (Bits)		Position	nER	nWA
		Singleturn	1	1
		34		
Data Format and Alignment		Binary coded, MSB first, right aligned		
CRC polynomial		0x43 (X <sup>6</sup> + X <sup>1</sup> + X <sup>0</sup> ) – CRC bit length 6 bits, CRC is inverted		
CRC Starting Value		0x00		
BiSS Timeout (tm)	µs	~20		
Switch-on Delay	ms	100		

1) Compatible with bidirectional interfaces supporting EDS register access and unidirectional interfaces  
 2) Achievable only if the data transmission time is shorter than one request cycle. Recommended MA Clock frequency 2MHz.

**Commutation Angle**

$$\text{Commutation Angle} = (\text{Position mod magnetic Period}) \cdot \frac{360^\circ}{\text{Magnetic Period}}$$

First, the position data is reduced to the range within a magnetic period using modulo.

This relative position value is then converted into an electrical angle.

**BISS-C-FRAME DESCRIPTION**

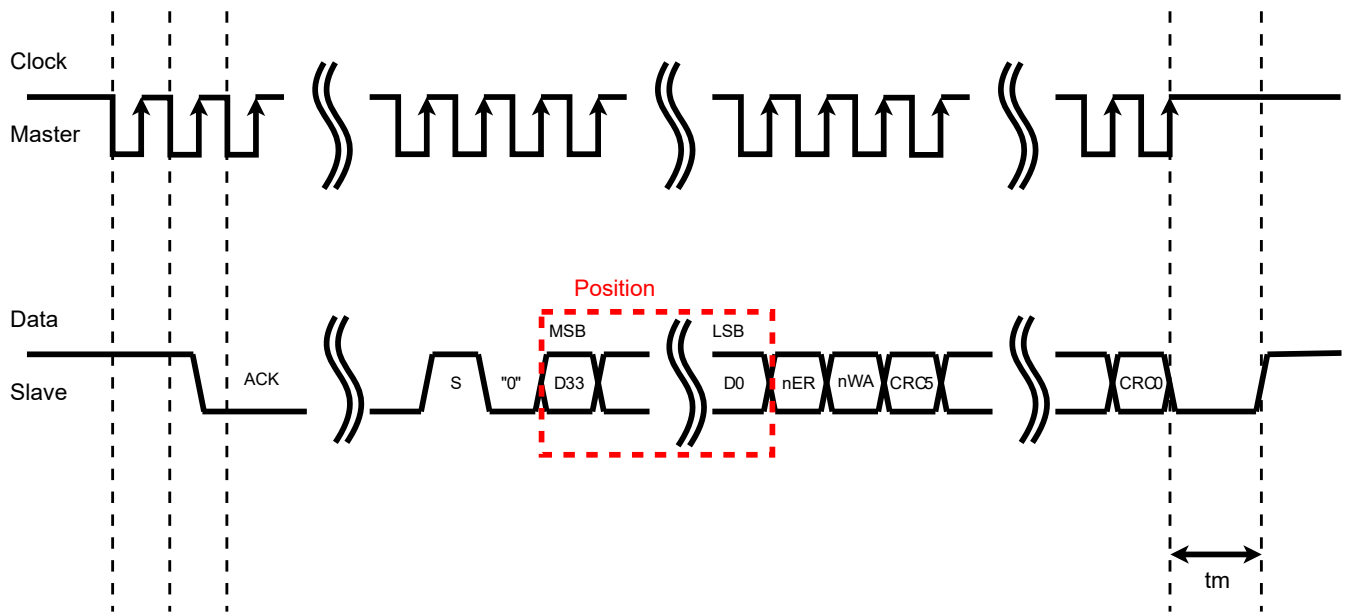

**Singleturn Position 34 Bit: D33-D0**

Binary coded, MSB first  
 Resolution per bit = 1  $\mu$ m  
 After switching on the encoder, the position starts with an offset of 3 m. In addition to the offset, the current position angle of the slider within a pole pair (magnetic period) of the motor is added to this. This position can be used for commutation.

**Errorbit: nER**

0: error; 1: no error (active low).  
 Indicates an encoder error. If this bit indicates an error, the position must be treated as invalid.

**Warnbit: nWA**

0: warning; 1: no warning (active low).  
 Displays encoder warnings. The position is still valid if only a warning is displayed.

**CRC 6 Bit: CRC5-0**

Polynomial : 0x43  
 Initial value : 0x00  
 The CRC is calculated via position, error and warning bits.  
 It is transmitted with MSB first and inverted. The start bit and the "0" bit are omitted from the CRC calculation.

**Register and Memory Definitions**

A description of how a BiSS-C master can access registers can be found at [www.biss-interface.com](http://www.biss-interface.com).

**BiSS-C - XML**

The encoder is compatible with the "Standard Encoder Profile (BP3)".  
 The function of the XML file is to automatically assign device properties in the master using the BiSS identifier.  
 The XML file can be used by masters to facilitate the configuration of slave devices. It can be downloaded from [www.linmot.com](http://www.linmot.com).

**CONNECTOR PS10-70X240U-BL-QJ-D34 (BISS-C INTERFACE FOR 3RD PARTY DRIVES)**

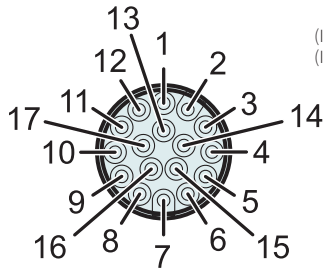

3 ... 13VDC  
 (I<sub>max</sub> < 150mA @ 5VDC)  
 (I<sub>max</sub> < 80mA @ 12VDC)

**Connector Encoder J**

View: Motor connector, plug side

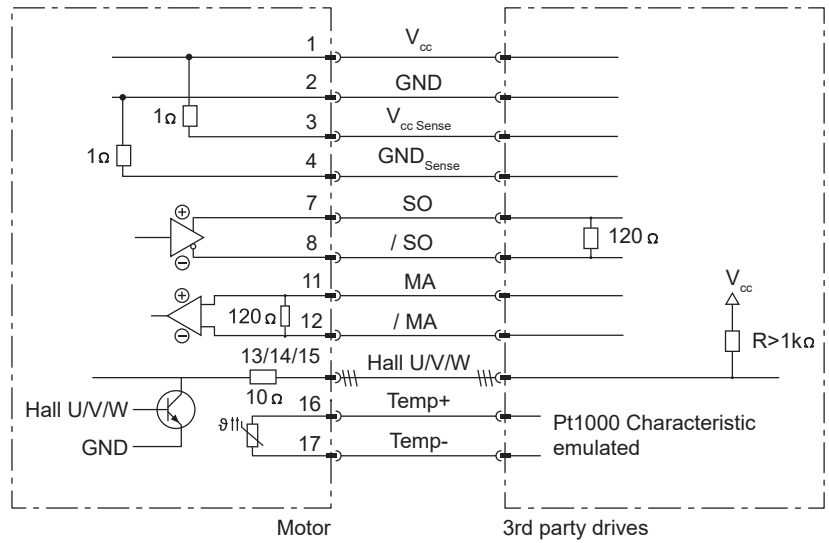

BiSS-C-Interface: Encoder Connector Wiring			
PS10-70x240U-BL-QJ-D34	Function	Connector Encoder J	Wire Color Motor Cable KSS05-02/13
3 ... 13VDC	Supply	1	white
GND	Supply	2	brown
Vcc Sense (optional)	Supply Sense	3	green
GND Sense (optional)	Supply Sense	4	yellow
Do not connect	-	5	-
Do not connect	-	6	-
SO (Slave out)	Encoder RS422	7	grey
/ SO (Slave out)	Encoder RS422	8	pink
Do not connect	-	9	blue
Do not connect	-	10	red
MA (Master clock)	Encoder RS422	11	black
/ MA (Master clock)	Encoder RS422	12	purple
Hall U	Encoder (open collector)	13	grey-red
Hall V	Encoder (open collector)	14	red-blue
Hall W	Encoder (open collector)	15	white-green
Temp+ (Pt1000)	Temperature <sup>1</sup>	16	yellow-brown
Temp- (Pt1000)	Temperature <sup>1</sup>	17	white-yellow

1) The temperature evaluation circuit must have the same galvanic reference potential as the encoder circuit (supply). It should therefore be connected to the supply GND. For correct evaluation, the connection potentials of the emulated temperature sensor must be in the range of the supply potentials. Valid temperature values can only be measured 50ms after the encoder supply is applied. In the currentless state, a resistance of 200kOhm is measured between pin 16 and 17 is measured. The maximum voltage between pin 16 and 17 must not exceed 16VDC. The maximum current is 15mA.

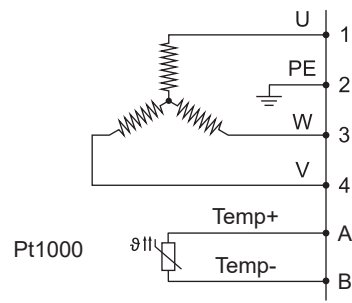
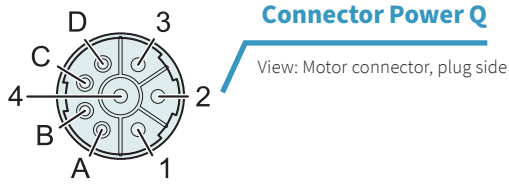

BiSS-C-Interface: Power Connector Wiring			
PS10-70x240U-BL-QJ-D34	Connector Power Q	Wire Color Motor Cable KPS15-04	Wire Color Motor Cable KPS15-04/04
Phase U	1	red	red
PE	2	yellow-green	yellow-green
Phase W	3	black	black
Phase V	4	blue	blue
Pt1000+ <sup>1)</sup>	A	n. c.	purple
Pt1000- <sup>1)</sup>	B	n. c.	grey
n. c.	C	n. c.	yellow
n. c.	D	n. c.	brown

1) The temperature evaluation circuit must have the same galvanic reference potential as the encoder circuit (supply). It should therefore be connected to the supply GND. For correct evaluation, the connection potentials of the emulated temperature sensor must be in the range of the supply potentials. Valid temperature values can only be measured 50ms after the encoder supply is applied. In currentless state a resistance of 200kOhm is measured between pin A and B. The maximum voltage between pin A and B must not exceed 16VDC. The maximum current is 15mA.

## TEMPERATURE FEEDBACK DX4

Overheating protection is provided by three internal thermistors embedded in the motor windings. These thermistors are monitored by the motor electronics. A single thermistor is simulated based on the maximum temperature readings. This is done in order to accurately monitor the temperature over the entire length of the stator and to react as quickly as possible to dynamic changes in a single motor phase. If the temperature

of the motor winding reaches its absolute maximum value, the drive amplifier/servo controller must switch off the motor to protect it from damage due to overheating. A DX4 temperature interface is available to support the temperature evaluation provided by the drive amplifier/servo controller. LinMot offers the appropriate motor cables for this purpose (see overview table in the Accessories/Motor Cables section).

### D34 (Pt1000 dual)

Both the **signal** and **power connectors** feature an emulated **Pt1000 thermistor** for evaluating the maximum motor temperature.

**SLIDER**

**Slider Standard**

The groove marks the front slider end.

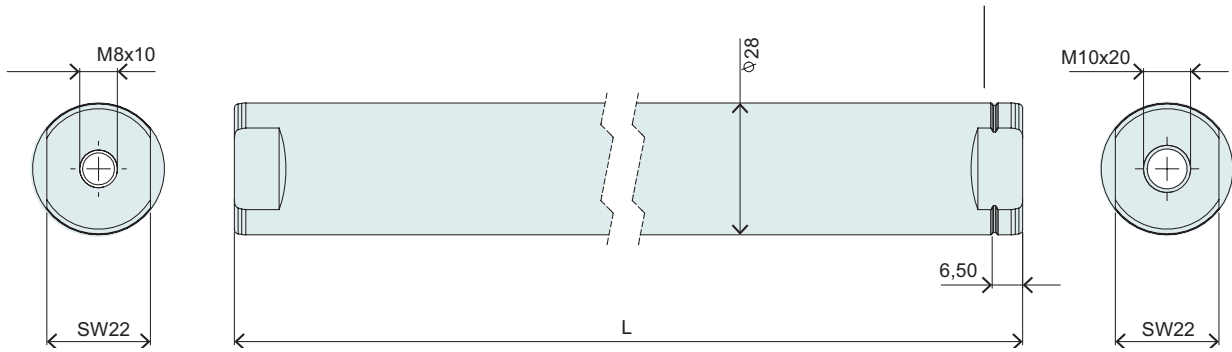

Slider Standard			
Item	Description	Max. Stroke [mm]	Item-No.
PL10-28x390/340	Slider for P10-70 'standard'	90	<a href="#">0150-2194</a>
PL10-28x490/440	Slider for P10-70 'standard'	190	<a href="#">0150-2195</a>
PL10-28x590/540	Slider for P10-70 'standard'	290	<a href="#">0150-2196</a>
PL10-28x690/640	Slider for P10-70 'standard'	390	<a href="#">0150-2197</a>
PL10-28x790/740	Slider for P10-70 'standard'	490	<a href="#">0150-2198</a>
PL10-28x890/840	Slider for P10-70 'standard'	590	<a href="#">0150-2199</a>
PL10-28x990/940	Slider for P10-70 'standard'	690	<a href="#">0150-2203</a>
PL10-28x1190/1140	Slider for P10-70 'standard'	890	<a href="#">0150-2204</a>
PL10-28x1390/1340	Slider for P10-70 'standard'	1090	<a href="#">0150-2205</a>
PL10-28x1590/1540	Slider for P10-70 'standard'	1290	<a href="#">0150-2206</a>
PL10-28x1790/1740	Slider for P10-70 'standard'	1490	<a href="#">0150-2207</a>
PL10-28x1990/1940	Läufer für P10-70 'standard'	1690	<a href="#">0150-2208</a>

**P10-70x240U/10-BL-QJ**

**Max. Stroke:** 10 mm  
**Peak Force:** 1650 N

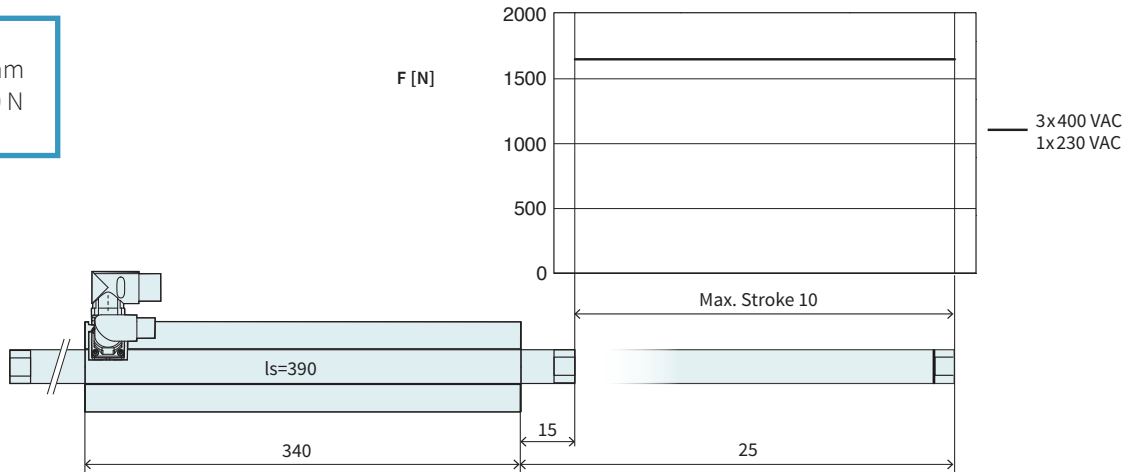

Dimensions in mm

Stroke			
Max. Stroke	mm (in)	10 (0.39)	
Force			
Max. Force <sup>1</sup> @ 1x230VAC	N (lbf)	1650 (371)	
Max. Force <sup>1</sup> @ 3x400VAC	N (lbf)	1650 (371)	
Max. Cont. Force [Passive cooling/ Fan / Fluid]	N (lbf)	190 / 290 / 510 (43 / 66 / 120)	
Max. Border Force relative	%	100	
Force Constant 1	N/A <sub>pk</sub> (lbf/A <sub>pk</sub> )	59 (13.3)	
Force Constant 2	N/A <sub>rms</sub> (lbf/A <sub>rms</sub> )	83.4 (18.8)	
Velocity			
Max. Velocity @ 1x230VAC	m/s (in/s)	3 (119.9)	
Max. Velocity @ 3x400VAC	m/s (in/s)	5.4 (5.4)	
Position Detection			
Repeatability	mm (in)	±0.05 (±0.002)	
Linearity	%	± 5.1	
Electrical Data			
Max. Current <sup>1</sup> @ 1x230VAC	A <sub>pk</sub> / A <sub>rms</sub>	27.9 / 19.7	
Max. Current <sup>1</sup> @ 3x400VAC	A <sub>pk</sub> / A <sub>rms</sub>	27.9 / 19.7	
Max. Cont. Current 1 [Passive cooling / Fan / Fluid]	A <sub>pk</sub>	3.3 / 5 / 8.7	
Max. Cont. Current 2 [Passive cooling / Fan / Fluid]	A <sub>rms</sub>	2.3 / 3.5 / 6.1	
Thermal Data			
Max. Winding Temperature (Sensor)	°C	90	
Thermal Resistance [Passive cooling / Fan / Fluid]	°K/W	0.87 / 0.38 / 0.12	
Thermal Time Constant [Passive cooling / Fan / Fluid]	s	2100 / 510 / 110	
Mechanical Data			
Slider Length	mm (in)	390 (15)	
Slider Mass	g (lb)	1830 (4.03)	

<sup>1</sup> Real time calculation of motor winding temperature is required (including monitoring).  
 If temperature monitoring is only based on temperature sensor signal (missing thermal model calculation), 60 % of the peak value has to be taken instead.



Item	Description	Item-No.
<b>PS10-70x240U-BL-QJ</b>	Stator 3x400VAC, LinMot Encoder	<a href="#">0150-1293</a>
<b>PS10-70x240U-BL-QJ-D04</b>	Stator 3x400VAC, Sin/Cos Encoder 1Vpp, Pt1000 dual	<a href="#">0150-4262</a>
<b>PS10-70x240U-BL-QJ-D05</b>	Stator 3x400VAC, Sin/Cos Encoder 1Vpp, PTC dual	<a href="#">0150-4607</a>
<b>PS10-70x240U-BL-QJ-D08</b>	Stator 3x400VAC, Sin/Cos Encoder 1Vpp, KTY dual	<a href="#">0150-4512</a>
<b>PS10-70x240U-BL-QJ-D24</b>	Stator 3x400VAC, A/B Encoder 1µm, Pt1000 dual	<a href="#">0150-4132</a>
<b>PS10-70x240U-BL-QJ-D24S</b>	Stator 3x400VAC, A/B Encoder 5µm, Pt1000 dual	<a href="#">0150-4597</a>
<b>PS10-70x240U-BL-QJ-D25</b>	Stator 3x400VAC, A/B Encoder 1µm, PTC dual	<a href="#">0150-5762</a>
<b>PS10-70x240U-BL-QJ-D25S</b>	Stator 3x400VAC, A/B Encoder 5µm, PTC dual	<a href="#">0150-4602</a>
<b>PS10-70x240U-BL-QJ-D26</b>	Stator 3x400VAC, A/B Encoder 1µm, PTC single ended	<a href="#">0150-4516</a>
<b>PS10-70x240U-BL-QJ-D34</b>	Stator 3x400VAC, BiSS-C, Pt1000 dual	<a href="#">0150-4872</a>
<b>PL10-28x390/340</b>	Slider for P10-70 'standard'	<a href="#">0150-2194</a>

**P10-70x240U/110-BL-QJ**

**Max. Stroke:** 110 mm  
**Peak Force:** 1650 N

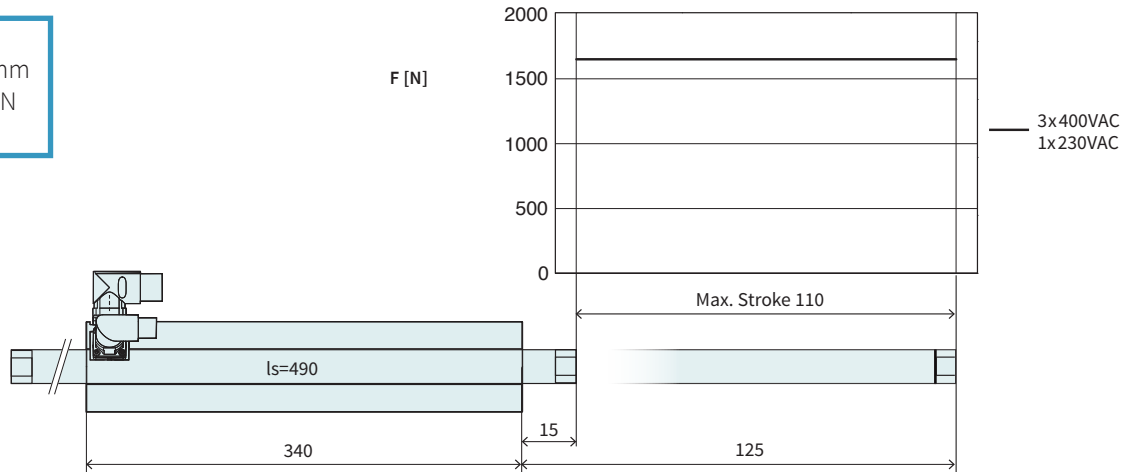

Dimensions in mm

Stroke			
Max. Stroke	mm (in)	110 (4.32)	
Force			
Max. Force <sup>1</sup> @ 1x230VAC	N (lbf)	1650 (371)	
Max. Force <sup>1</sup> @ 3x400VAC	N (lbf)	1650 (371)	
Max. Cont. Force [Passive cooling / Fan / Fluid]	N (lbf)	190 / 290 / 510 (43 / 66 / 120)	
Max. Border Force relative	%	100	
Force Constant 1	N/A <sub>pk</sub> (lbf/A <sub>pk</sub> )	59 (13.3)	
Force Constant 2	N/A <sub>rms</sub> (lbf/A <sub>rms</sub> )	83.4 (18.8)	
Velocity			
Max. Velocity @ 1x230VAC	m/s (in/s)	3 (119.9)	
Max. Velocity @ 3x400VAC	m/s (in/s)	5.4 (5.4)	
Position Detection			
Repeatability	mm (in)	±0.05 (±0.002)	
Linearity	%	± 0.55	
Electrical Data			
Max. Current <sup>1</sup> @ 1x230VAC	A <sub>pk</sub> / A <sub>rms</sub>	27.9 / 19.7	
Max. Current <sup>1</sup> @ 3x400VAC	A <sub>pk</sub> / A <sub>rms</sub>	27.9 / 19.7	
Max. Cont. Current 1 [Passive cooling / Fan / Fluid]	A <sub>pk</sub>	3.3 / 5 / 8.7	
Max. Cont. Current 2 [Passive cooling / Fan / Fluid]	A <sub>rms</sub>	2.3 / 3.5 / 6.1	
Thermal Data			
Max. Winding Temperature (Sensor)	°C	90	
Thermal Resistance [Passive cooling / Fan / Fluid]	°K/W	0.87 / 0.38 / 0.12	
Thermal Time Constant [Passive cooling / Fan / Fluid]	s	2100 / 510 / 110	
Mechanical Data			
Slider Length	mm (in)	490 (19)	
Slider Mass	g (lb)	2300 (5.06)	

1) Real time calculation of motor winding temperature is required (including monitoring).  
 If temperature monitoring is only based on temperature sensor signal (missing thermal model calculation), 60% of the peak value has to be taken instead.

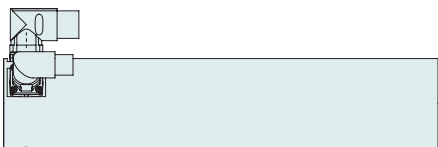

Item	Description	Item-No.
<b>PS10-70x240U-BL-QJ</b>	Stator 3x400VAC, LinMot Encoder	<a href="#">0150-1293</a>
<b>PS10-70x240U-BL-QJ-D04</b>	Stator 3x400VAC, Sin/Cos Encoder 1Vpp, Pt1000 dual	<a href="#">0150-4262</a>
<b>PS10-70x240U-BL-QJ-D05</b>	Stator 3x400VAC, Sin/Cos Encoder 1Vpp, PTC dual	<a href="#">0150-4607</a>
<b>PS10-70x240U-BL-QJ-D08</b>	Stator 3x400VAC, Sin/Cos Encoder 1Vpp, KTY dual	<a href="#">0150-4512</a>
<b>PS10-70x240U-BL-QJ-D24</b>	Stator 3x400VAC, A/B Encoder 1µm, Pt1000 dual	<a href="#">0150-4132</a>
<b>PS10-70x240U-BL-QJ-D24S</b>	Stator 3x400VAC, A/B Encoder 5µm, Pt1000 dual	<a href="#">0150-4597</a>
<b>PS10-70x240U-BL-QJ-D25</b>	Stator 3x400VAC, A/B Encoder 1µm, PTC dual	<a href="#">0150-5762</a>
<b>PS10-70x240U-BL-QJ-D25S</b>	Stator 3x400VAC, A/B Encoder 5µm, PTC dual	<a href="#">0150-4602</a>
<b>PS10-70x240U-BL-QJ-D26</b>	Stator 3x400VAC, A/B Encoder 1µm, PTC single ended	<a href="#">0150-4516</a>
<b>PS10-70x240U-BL-QJ-D34</b>	Stator 3x400VAC, BiSS-C, Pt1000 dual	<a href="#">0150-4872</a>
<b>PL10-28x490/440</b>	Slider for P10-70 'standard'	<a href="#">0150-2195</a>

**P10-70x240U/210-BL-QJ**

**Max. Stroke:** 210 mm  
**Peak Force:** 1650 N

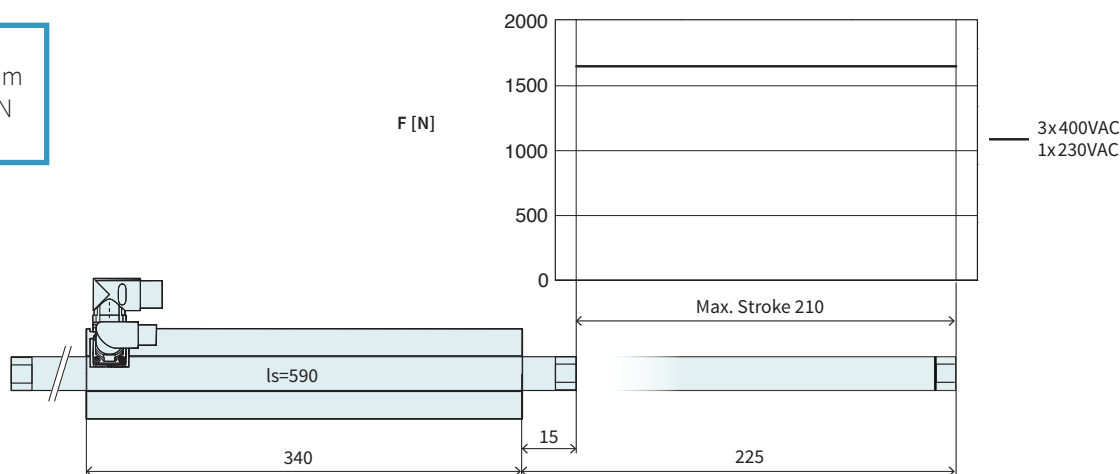

Dimensions in mm

Stroke			
Max. Stroke	mm (in)	210 (8.26)	
Force			
Max. Force <sup>1</sup> @ 1x230VAC	N (lbf)	1650 (371)	
Max. Force <sup>1</sup> @ 3x400VAC	N (lbf)	1650 (371)	
Max. Cont. Force [Passive cooling/ Fan / Fluid]	N (lbf)	190 / 290 / 510 (43 / 66 / 120)	
Max. Border Force relative	%	100	
Force Constant 1	N/A <sub>pk</sub> (lbf/A <sub>pk</sub> )	59 (13.3)	
Force Constant 2	N/A <sub>rms</sub> (lbf/A <sub>rms</sub> )	83.4 (18.8)	
Velocity			
Max. Velocity @ 1x230VAC	m/s (in/s)	3 (119.9)	
Max. Velocity @ 3x400VAC	m/s (in/s)	5.4 (5.4)	
Position Detection			
Repeatability	mm (in)	±0.05 (±0.002)	
Linearity	%	± 0.35	
Electrical Data			
Max. Current <sup>1</sup> @ 1x230VAC	A <sub>pk</sub> / A <sub>rms</sub>	27.9 / 19.7	
Max. Current <sup>1</sup> @ 3x400VAC	A <sub>pk</sub> / A <sub>rms</sub>	27.9 / 19.7	
Max. Cont. Current 1 [Passive cooling / Fan / Fluid]	A <sub>pk</sub>	3.3 / 5 / 8.7	
Max. Cont. Current 2 [Passive cooling / Fan / Fluid]	A <sub>rms</sub>	2.3 / 3.5 / 6.1	
Thermal Data			
Max. Winding Temperature (Sensor)	°C	90	
Thermal Resistance [Passive cooling / Fan / Fluid]	°K/W	0.87 / 0.38 / 0.12	
Thermal Time Constant [Passive cooling / Fan / Fluid]	s	2100 / 510 / 110	
Mechanical Data			
Slider Length	mm (in)	590 (23)	
Slider Mass	g (lb)	2770 (6.09)	

<sup>1</sup> Real time calculation of motor winding temperature is required (including monitoring).  
 If temperature monitoring is only based on temperature sensor signal (missing thermal model calculation), 60 % of the peak value has to be taken instead.



Item	Description	Item-No.
<b>PS10-70x240U-BL-QJ</b>	Stator 3x400VAC, LinMot Encoder	<a href="#">0150-1293</a>
<b>PS10-70x240U-BL-QJ-D04</b>	Stator 3x400VAC, Sin/Cos Encoder 1Vpp, Pt1000 dual	<a href="#">0150-4262</a>
<b>PS10-70x240U-BL-QJ-D05</b>	Stator 3x400VAC, Sin/Cos Encoder 1Vpp, PTC dual	<a href="#">0150-4607</a>
<b>PS10-70x240U-BL-QJ-D08</b>	Stator 3x400VAC, Sin/Cos Encoder 1Vpp, KTY dual	<a href="#">0150-4512</a>
<b>PS10-70x240U-BL-QJ-D24</b>	Stator 3x400VAC, A/B Encoder 1µm, Pt1000 dual	<a href="#">0150-4132</a>
<b>PS10-70x240U-BL-QJ-D24S</b>	Stator 3x400VAC, A/B Encoder 5µm, Pt1000 dual	<a href="#">0150-4597</a>
<b>PS10-70x240U-BL-QJ-D25</b>	Stator 3x400VAC, A/B Encoder 1µm, PTC dual	<a href="#">0150-5762</a>
<b>PS10-70x240U-BL-QJ-D25S</b>	Stator 3x400VAC, A/B Encoder 5µm, PTC dual	<a href="#">0150-4602</a>
<b>PS10-70x240U-BL-QJ-D26</b>	Stator 3x400VAC, A/B Encoder 1µm, PTC single ended	<a href="#">0150-4516</a>
<b>PS10-70x240U-BL-QJ-D34</b>	Stator 3x400VAC, BiSS-C, Pt1000 dual	<a href="#">0150-4872</a>
<b>PL10-28x590/540</b>	Slider for P10-70 'standard'	<a href="#">0150-2196</a>

**P10-70x240U/310-BL-QJ**

**Max. Stroke:** 310 mm  
**Peak Force:** 1650 N

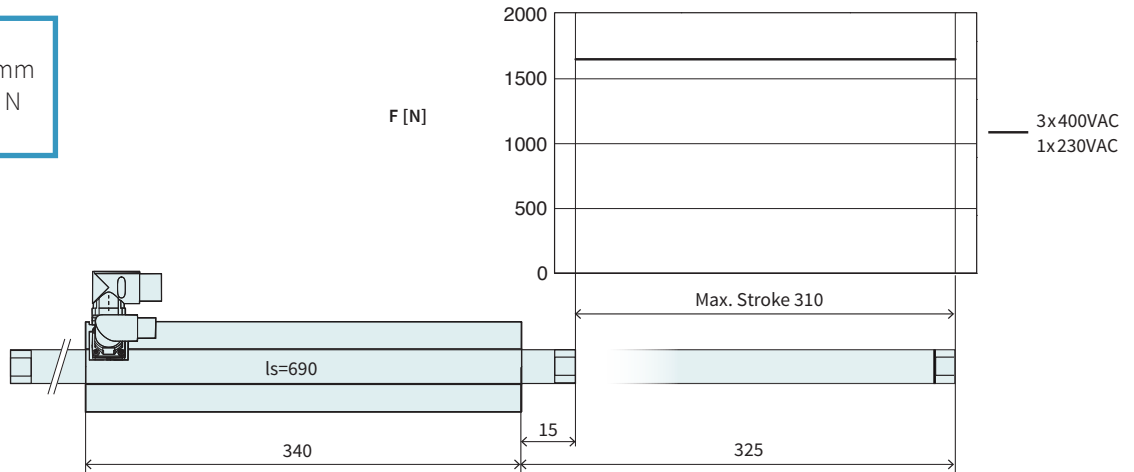

Dimensions in mm

Stroke			
Max. Stroke	mm (in)		310 (12.19)
Force			
Max. Force <sup>1</sup> @ 1x230VAC	N (lbf)		1650 (371)
Max. Force <sup>1</sup> @ 3x400VAC	N (lbf)		1650 (371)
Max. Cont. Force [Passive cooling / Fan / Fluid]	N (lbf)		190 / 290 / 510 (43 / 66 / 120)
Max. Border Force relative	%		100
Force Constant 1	N/A <sub>pk</sub> (lbf/A <sub>pk</sub> )		59 (13.3)
Force Constant 2	N/A <sub>rms</sub> (lbf/A <sub>rms</sub> )		83.4 (18.8)
Velocity			
Max. Velocity @ 1x230VAC	m/s (in/s)		3 (119.9)
Max. Velocity @ 3x400VAC	m/s (in/s)		5.4 (5.4)
Position Detection			
Repeatability	mm (in)		±0.05 (±0.002)
Linearity	%		± 0.25
Electrical Data			
Max. Current <sup>1</sup> @ 1x230VAC	A <sub>pk</sub> / A <sub>rms</sub>		27.9 / 19.7
Max. Current <sup>1</sup> @ 3x400VAC	A <sub>pk</sub> / A <sub>rms</sub>		27.9 / 19.7
Max. Cont. Current 1 [Passive cooling / Fan / Fluid]	A <sub>pk</sub>		3.3 / 5 / 8.7
Max. Cont. Current 2 [Passive cooling / Fan / Fluid]	A <sub>rms</sub>		2.3 / 3.5 / 6.1
Thermal Data			
Max. Winding Temperature (Sensor)	°C		90
Thermal Resistance [Passive cooling / Fan / Fluid]	°K/W		0.87 / 0.38 / 0.12
Thermal Time Constant [Passive cooling / Fan / Fluid]	s		2100 / 510 / 110
Mechanical Data			
Slider Length	mm (in)		690 (27)
Slider Mass	g (lb)		3240 (7.13)

1) Real time calculation of motor winding temperature is required (including monitoring).  
 If temperature monitoring is only based on temperature sensor signal (missing thermal model calculation), 60% of the peak value has to be taken instead.



Item	Description	Item-No.
<b>PS10-70x240U-BL-QJ</b>	Stator 3x400VAC, LinMot Encoder	<a href="#">0150-1293</a>
<b>PS10-70x240U-BL-QJ-D04</b>	Stator 3x400VAC, Sin/Cos Encoder 1Vpp, Pt1000 dual	<a href="#">0150-4262</a>
<b>PS10-70x240U-BL-QJ-D05</b>	Stator 3x400VAC, Sin/Cos Encoder 1Vpp, PTC dual	<a href="#">0150-4607</a>
<b>PS10-70x240U-BL-QJ-D08</b>	Stator 3x400VAC, Sin/Cos Encoder 1Vpp, KTY dual	<a href="#">0150-4512</a>
<b>PS10-70x240U-BL-QJ-D24</b>	Stator 3x400VAC, A/B Encoder 1µm, Pt1000 dual	<a href="#">0150-4132</a>
<b>PS10-70x240U-BL-QJ-D24S</b>	Stator 3x400VAC, A/B Encoder 5µm, Pt1000 dual	<a href="#">0150-4597</a>
<b>PS10-70x240U-BL-QJ-D25</b>	Stator 3x400VAC, A/B Encoder 1µm, PTC dual	<a href="#">0150-5762</a>
<b>PS10-70x240U-BL-QJ-D25S</b>	Stator 3x400VAC, A/B Encoder 5µm, PTC dual	<a href="#">0150-4602</a>
<b>PS10-70x240U-BL-QJ-D26</b>	Stator 3x400VAC, A/B Encoder 1µm, PTC single ended	<a href="#">0150-4516</a>
<b>PS10-70x240U-BL-QJ-D34</b>	Stator 3x400VAC, BiSS-C, Pt1000 dual	<a href="#">0150-4872</a>
<b>PL10-28x690/640</b>	Slider for P10-70 'standard'	<a href="#">0150-2197</a>

**P10-70x240U/410-BL-QJ**

**Max. Stroke:** 410 mm  
**Peak Force:** 1650 N

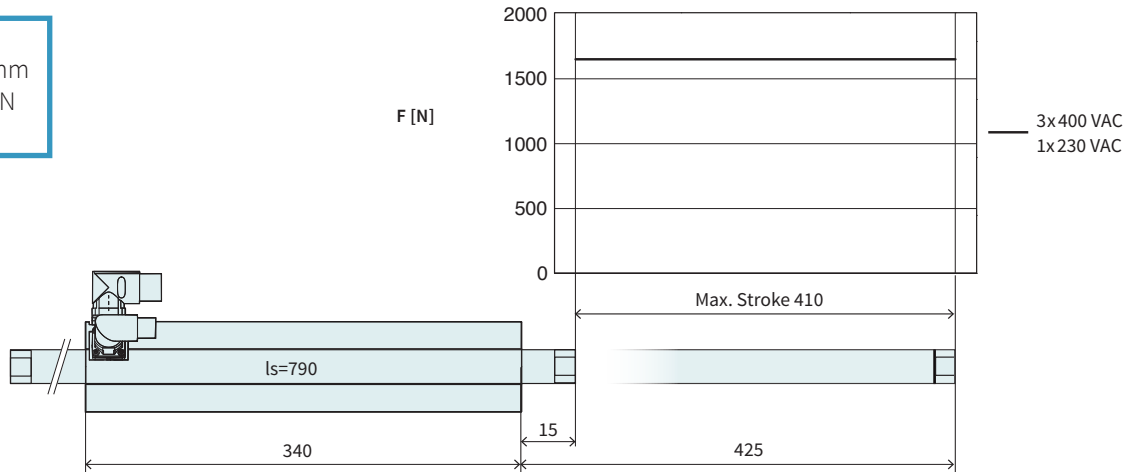

Dimensions in mm

Stroke			
Max. Stroke	mm (in)		410 (16.1)
Force			
Max. Force <sup>1</sup> @ 1x230VAC	N (lbf)		1650 (371)
Max. Force <sup>1</sup> @ 3x400VAC	N (lbf)		1650 (371)
Max. Cont. Force [Passive cooling / Fan / Fluid]	N (lbf)		190 / 290 / 510 (43 / 66 / 120)
Max. Border Force relative	%		100
Force Constant 1	N/A <sub>pk</sub> (lbf/A <sub>pk</sub> )		59 (13.3)
Force Constant 2	N/A <sub>rms</sub> (lbf/A <sub>rms</sub> )		83.4 (18.8)
Velocity			
Max. Velocity @ 1x230VAC	m/s (in/s)		3 (119.9)
Max. Velocity @ 3x400VAC	m/s (in/s)		5.4 (5.4)
Position Detection			
Repeatability	mm (in)		±0.05 (±0.002)
Linearity	%		± 0.2
Electrical Data			
Max. Current <sup>1</sup> @ 1x230VAC	A <sub>pk</sub> / A <sub>rms</sub>		27.9 / 19.7
Max. Current <sup>1</sup> @ 3x400VAC	A <sub>pk</sub> / A <sub>rms</sub>		27.9 / 19.7
Max. Cont. Current 1 [Passive cooling / Fan / Fluid]	A <sub>pk</sub>		3.3 / 5 / 8.7
Max. Cont. Current 2 [Passive cooling / Fan / Fluid]	A <sub>rms</sub>		2.3 / 3.5 / 6.1
Thermal Data			
Max. Winding Temperature (Sensor)	°C		90
Thermal Resistance [Passive cooling / Fan / Fluid]	°K/W		0.87 / 0.38 / 0.12
Thermal Time Constant [Passive cooling / Fan / Fluid]	s		2100 / 510 / 110
Mechanical Data			
Slider Length	mm (in)		790 (31)
Slider Mass	g (lb)		3710 (8.16)

<sup>1</sup> Real time calculation of motor winding temperature is required (including monitoring).  
 If temperature monitoring is only based on temperature sensor signal (missing thermal model calculation), 60 % of the peak value has to be taken instead.



Item	Description	Item-No.
<b>PS10-70x240U-BL-QJ</b>	Stator 3x400VAC, LinMot Encoder	<a href="#">0150-1293</a>
<b>PS10-70x240U-BL-QJ-D04</b>	Stator 3x400VAC, Sin/Cos Encoder 1Vpp, Pt1000 dual	<a href="#">0150-4262</a>
<b>PS10-70x240U-BL-QJ-D05</b>	Stator 3x400VAC, Sin/Cos Encoder 1Vpp, PTC dual	<a href="#">0150-4607</a>
<b>PS10-70x240U-BL-QJ-D08</b>	Stator 3x400VAC, Sin/Cos Encoder 1Vpp, KTY dual	<a href="#">0150-4512</a>
<b>PS10-70x240U-BL-QJ-D24</b>	Stator 3x400VAC, A/B Encoder 1µm, Pt1000 dual	<a href="#">0150-4132</a>
<b>PS10-70x240U-BL-QJ-D24S</b>	Stator 3x400VAC, A/B Encoder 5µm, Pt1000 dual	<a href="#">0150-4597</a>
<b>PS10-70x240U-BL-QJ-D25</b>	Stator 3x400VAC, A/B Encoder 1µm, PTC dual	<a href="#">0150-5762</a>
<b>PS10-70x240U-BL-QJ-D25S</b>	Stator 3x400VAC, A/B Encoder 5µm, PTC dual	<a href="#">0150-4602</a>
<b>PS10-70x240U-BL-QJ-D26</b>	Stator 3x400VAC, A/B Encoder 1µm, PTC single ended	<a href="#">0150-4516</a>
<b>PS10-70x240U-BL-QJ-D34</b>	Stator 3x400VAC, BiSS-C, Pt1000 dual	<a href="#">0150-4872</a>
<b>PL10-28x790/740</b>	Slider for P10-70 'standard'	<a href="#">0150-2198</a>

**P10-70x240U/510-BL-QJ**

**Max. Stroke:** 510 mm  
**Peak Force:** 1650 N

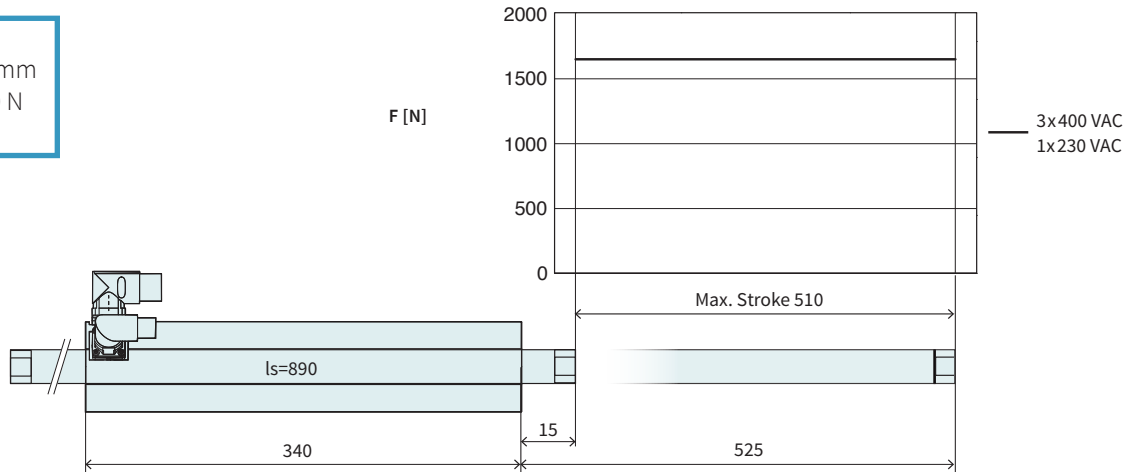

Dimensions in mm

Stroke			
Max. Stroke	mm (in)		510 (20.1)
Force			
Max. Force <sup>1</sup> @ 1x230VAC	N (lbf)		1650 (371)
Max. Force <sup>1</sup> @ 3x400VAC	N (lbf)		1650 (371)
Max. Cont. Force [Passive cooling / Fan / Fluid]	N (lbf)		190 / 290 / 510 (43 / 66 / 120)
Max. Border Force relative	%		100
Force Constant 1	N/A <sub>pk</sub> (lbf/A <sub>pk</sub> )		59 (13.3)
Force Constant 2	N/A <sub>rms</sub> (lbf/A <sub>rms</sub> )		83.4 (18.8)
Velocity			
Max. Velocity @ 1x230VAC	m/s (in/s)		3 (119.9)
Max. Velocity @ 3x400VAC	m/s (in/s)		5.4 (5.4)
Position Detection			
Repeatability	mm (in)		±0.05 (±0.002)
Linearity	%		± 0.2
Electrical Data			
Max. Current <sup>1</sup> @ 1x230VAC	A <sub>pk</sub> / A <sub>rms</sub>		27.9 / 19.7
Max. Current <sup>1</sup> @ 3x400VAC	A <sub>pk</sub> / A <sub>rms</sub>		27.9 / 19.7
Max. Cont. Current 1 [Passive cooling / Fan / Fluid]	A <sub>pk</sub>		3.3 / 5 / 8.7
Max. Cont. Current 2 [Passive cooling / Fan / Fluid]	A <sub>rms</sub>		2.3 / 3.5 / 6.1
Thermal Data			
Max. Winding Temperature (Sensor)	°C		90
Thermal Resistance [Passive cooling / Fan / Fluid]	°K/W		0.87 / 0.38 / 0.12
Thermal Time Constant [Passive cooling / Fan / Fluid]	s		2100 / 510 / 110
Mechanical Data			
Slider Length	mm (in)		890 (35)
Slider Mass	g (lb)		4180 (9.2)

1) Real time calculation of motor winding temperature is required (including monitoring).  
 If temperature monitoring is only based on temperature sensor signal (missing thermal model calculation), 60% of the peak value has to be taken instead.



Item	Description	Item-No.
<b>PS10-70x240U-BL-QJ</b>	Stator 3x400VAC, LinMot Encoder	<a href="#">0150-1293</a>
<b>PS10-70x240U-BL-QJ-D04</b>	Stator 3x400VAC, Sin/Cos Encoder 1Vpp, Pt1000 dual	<a href="#">0150-4262</a>
<b>PS10-70x240U-BL-QJ-D05</b>	Stator 3x400VAC, Sin/Cos Encoder 1Vpp, PTC dual	<a href="#">0150-4607</a>
<b>PS10-70x240U-BL-QJ-D08</b>	Stator 3x400VAC, Sin/Cos Encoder 1Vpp, KTY dual	<a href="#">0150-4512</a>
<b>PS10-70x240U-BL-QJ-D24</b>	Stator 3x400VAC, A/B Encoder 1µm, Pt1000 dual	<a href="#">0150-4132</a>
<b>PS10-70x240U-BL-QJ-D24S</b>	Stator 3x400VAC, A/B Encoder 5µm, Pt1000 dual	<a href="#">0150-4597</a>
<b>PS10-70x240U-BL-QJ-D25</b>	Stator 3x400VAC, A/B Encoder 1µm, PTC dual	<a href="#">0150-5762</a>
<b>PS10-70x240U-BL-QJ-D25S</b>	Stator 3x400VAC, A/B Encoder 5µm, PTC dual	<a href="#">0150-4602</a>
<b>PS10-70x240U-BL-QJ-D26</b>	Stator 3x400VAC, A/B Encoder 1µm, PTC single ended	<a href="#">0150-4516</a>
<b>PS10-70x240U-BL-QJ-D34</b>	Stator 3x400VAC, BiSS-C, Pt1000 dual	<a href="#">0150-4872</a>
<b>PL10-28x890/840</b>	Slider for P10-70 'standard'	<a href="#">0150-2199</a>

**P10-70x240U/610-BL-QJ**

**Max. Stroke:** 610 mm  
**Peak Force:** 1650 N

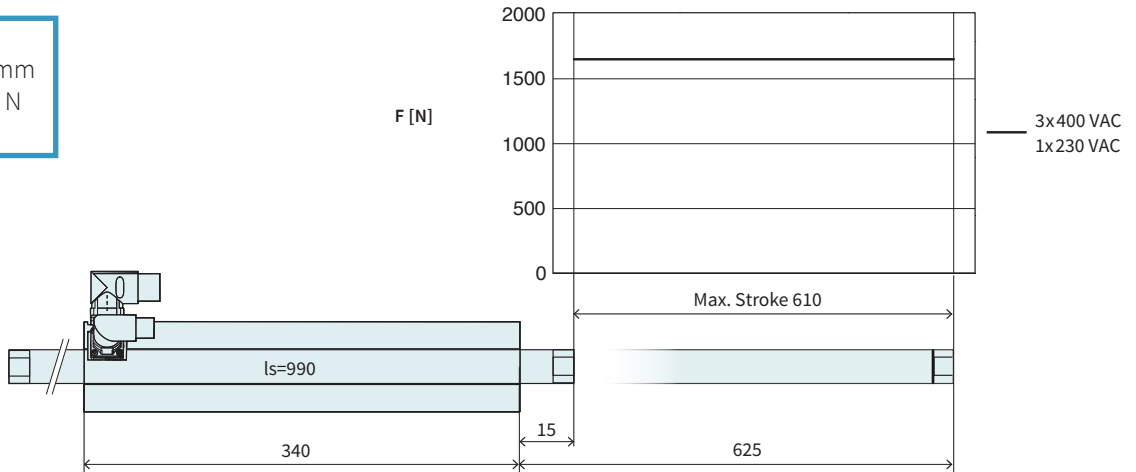

Dimensions in mm

Stroke			
Max. Stroke	mm (in)	610 (23.99)	
Force			
Max. Force <sup>1</sup> @ 1x230VAC	N (lbf)	1650 (371)	
Max. Force <sup>1</sup> @ 3x400VAC	N (lbf)	1650 (371)	
Max. Cont. Force [Passive cooling/ Fan / Fluid]	N (lbf)	190 / 290 / 510 (43 / 66 / 120)	
Max. Border Force relative	%	100	
Force Constant 1	N/A <sub>pk</sub> (lbf/A <sub>pk</sub> )	59 (13.3)	
Force Constant 2	N/A <sub>rms</sub> (lbf/A <sub>rms</sub> )	83.4 (18.8)	
Velocity			
Max. Velocity @ 1x230VAC	m/s (in/s)	3 (119.9)	
Max. Velocity @ 3x400VAC	m/s (in/s)	5.4 (5.4)	
Position Detection			
Repeatability	mm (in)	±0.05 (±0.002)	
Linearity	%	± 0.2	
Electrical Data			
Max. Current <sup>1</sup> @ 1x230VAC	A <sub>pk</sub> / A <sub>rms</sub>	27.9 / 19.7	
Max. Current <sup>1</sup> @ 3x400VAC	A <sub>pk</sub> / A <sub>rms</sub>	27.9 / 19.7	
Max. Cont. Current 1 [Passive cooling / Fan / Fluid]	A <sub>pk</sub>	3.3 / 5 / 8.7	
Max. Cont. Current 2 [Passive cooling / Fan / Fluid]	A <sub>rms</sub>	2.3 / 3.5 / 6.1	
Thermal Data			
Max. Winding Temperature (Sensor)	°C	90	
Thermal Resistance [Passive cooling / Fan / Fluid]	°K/W	0.87 / 0.38 / 0.12	
Thermal Time Constant [Passive cooling / Fan / Fluid]	s	2100 / 510 / 110	
Mechanical Data			
Slider Length	mm (in)	990 (39)	
Slider Mass	g (lb)	4650 (10.23)	

<sup>1</sup> Real time calculation of motor winding temperature is required (including monitoring).  
 If temperature monitoring is only based on temperature sensor signal (missing thermal model calculation), 60 % of the peak value has to be taken instead.



Item	Description	Item-No.
<b>PS10-70x240U-BL-QJ</b>	Stator 3x400VAC, LinMot Encoder	<a href="#">0150-1293</a>
<b>PS10-70x240U-BL-QJ-D04</b>	Stator 3x400VAC, Sin/Cos Encoder 1Vpp, Pt1000 dual	<a href="#">0150-4262</a>
<b>PS10-70x240U-BL-QJ-D05</b>	Stator 3x400VAC, Sin/Cos Encoder 1Vpp, PTC dual	<a href="#">0150-4607</a>
<b>PS10-70x240U-BL-QJ-D08</b>	Stator 3x400VAC, Sin/Cos Encoder 1Vpp, KTY dual	<a href="#">0150-4512</a>
<b>PS10-70x240U-BL-QJ-D24</b>	Stator 3x400VAC, A/B Encoder 1µm, Pt1000 dual	<a href="#">0150-4132</a>
<b>PS10-70x240U-BL-QJ-D24S</b>	Stator 3x400VAC, A/B Encoder 5µm, Pt1000 dual	<a href="#">0150-4597</a>
<b>PS10-70x240U-BL-QJ-D25</b>	Stator 3x400VAC, A/B Encoder 1µm, PTC dual	<a href="#">0150-5762</a>
<b>PS10-70x240U-BL-QJ-D25S</b>	Stator 3x400VAC, A/B Encoder 5µm, PTC dual	<a href="#">0150-4602</a>
<b>PS10-70x240U-BL-QJ-D26</b>	Stator 3x400VAC, A/B Encoder 1µm, PTC single ended	<a href="#">0150-4516</a>
<b>PS10-70x240U-BL-QJ-D34</b>	Stator 3x400VAC, BiSS-C, Pt1000 dual	<a href="#">0150-4872</a>
<b>PL10-28x990/940</b>	Slider for P10-70 'standard'	<a href="#">0150-2203</a>

**P10-70x240U/810-BL-QJ**

**Max. Stroke:** 810 mm  
**Peak Force:** 1650 N

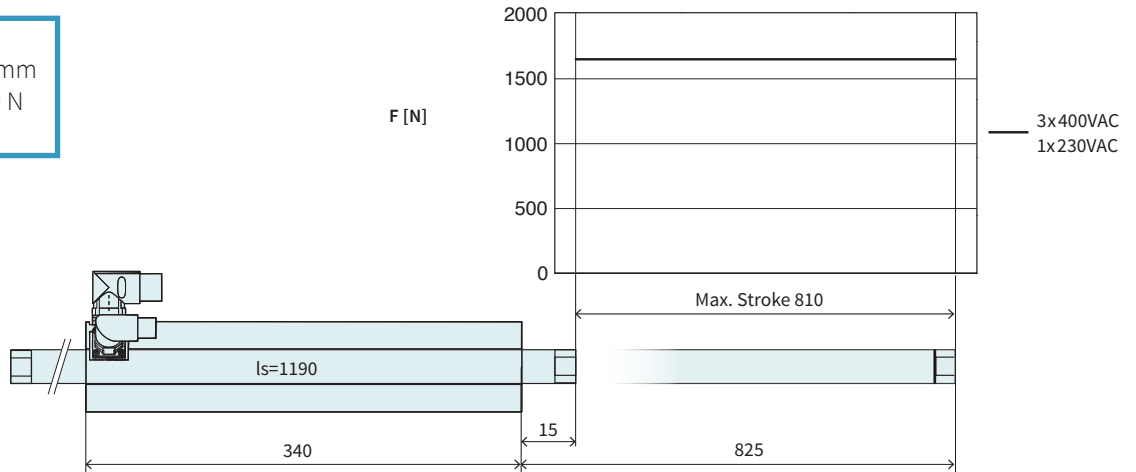

Dimensions in mm

Stroke			
Max. Stroke	mm (in)		810 (31.89)
Force			
Max. Force <sup>1</sup> @ 1x230VAC	N (lbf)		1650 (371)
Max. Force <sup>1</sup> @ 3x400VAC	N (lbf)		1650 (371)
Max. Cont. Force [Passive cooling / Fan / Fluid]	N (lbf)		190 / 290 / 510 (43 / 66 / 120)
Max. Border Force relative	%		100
Force Constant 1	N/A <sub>pk</sub> (lbf/A <sub>pk</sub> )		59 (13.3)
Force Constant 2	N/A <sub>rms</sub> (lbf/A <sub>rms</sub> )		83.4 (18.8)
Velocity			
Max. Velocity @ 1x230VAC	m/s (in/s)		3 (119.9)
Max. Velocity @ 3x400VAC	m/s (in/s)		5.4 (5.4)
Position Detection			
Repeatability	mm (in)		±0.05 (±0.002)
Linearity	%		± 0.15
Electrical Data			
Max. Current <sup>1</sup> @ 1x230VAC	A <sub>pk</sub> / A <sub>rms</sub>		27.9 / 19.7
Max. Current <sup>1</sup> @ 3x400VAC	A <sub>pk</sub> / A <sub>rms</sub>		27.9 / 19.7
Max. Cont. Current 1 [Passive cooling / Fan / Fluid]	A <sub>pk</sub>		3.3 / 5 / 8.7
Max. Cont. Current 2 [Passive cooling / Fan / Fluid]	A <sub>rms</sub>		2.3 / 3.5 / 6.1
Thermal Data			
Max. Winding Temperature (Sensor)	°C		90
Thermal Resistance [Passive cooling / Fan / Fluid]	°K/W		0.87 / 0.38 / 0.12
Thermal Time Constant [Passive cooling / Fan / Fluid]	s		2100 / 510 / 110
Mechanical Data			
Slider Length	mm (in)		1190 (47)
Slider Mass	g (lb)		5590 (12.3)

1) Real time calculation of motor winding temperature is required (including monitoring).  
 If temperature monitoring is only based on temperature sensor signal (missing thermal model calculation), 60% of the peak value has to be taken instead.

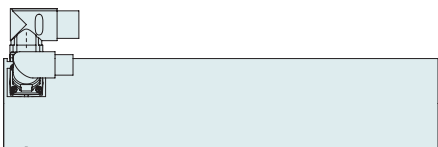

Item	Description	Item-No.
<b>PS10-70x240U-BL-QJ</b>	Stator 3x400VAC, LinMot Encoder	<a href="#">0150-1293</a>
<b>PS10-70x240U-BL-QJ-D04</b>	Stator 3x400VAC, Sin/Cos Encoder 1Vpp, Pt1000 dual	<a href="#">0150-4262</a>
<b>PS10-70x240U-BL-QJ-D05</b>	Stator 3x400VAC, Sin/Cos Encoder 1Vpp, PTC dual	<a href="#">0150-4607</a>
<b>PS10-70x240U-BL-QJ-D08</b>	Stator 3x400VAC, Sin/Cos Encoder 1Vpp, KTY dual	<a href="#">0150-4512</a>
<b>PS10-70x240U-BL-QJ-D24</b>	Stator 3x400VAC, A/B Encoder 1µm, Pt1000 dual	<a href="#">0150-4132</a>
<b>PS10-70x240U-BL-QJ-D24S</b>	Stator 3x400VAC, A/B Encoder 5µm, Pt1000 dual	<a href="#">0150-4597</a>
<b>PS10-70x240U-BL-QJ-D25</b>	Stator 3x400VAC, A/B Encoder 1µm, PTC dual	<a href="#">0150-5762</a>
<b>PS10-70x240U-BL-QJ-D25S</b>	Stator 3x400VAC, A/B Encoder 5µm, PTC dual	<a href="#">0150-4602</a>
<b>PS10-70x240U-BL-QJ-D26</b>	Stator 3x400VAC, A/B Encoder 1µm, PTC single ended	<a href="#">0150-4516</a>
<b>PS10-70x240U-BL-QJ-D34</b>	Stator 3x400VAC, BiSS-C, Pt1000 dual	<a href="#">0150-4872</a>
<b>PL10-28x1190/1140</b>	Slider for P10-70 'standard'	<a href="#">0150-2204</a>

**P10-70x240U/1010-BL-QJ**

**Max. Stroke:** 1010 mm  
**Peak Force:** 1650 N

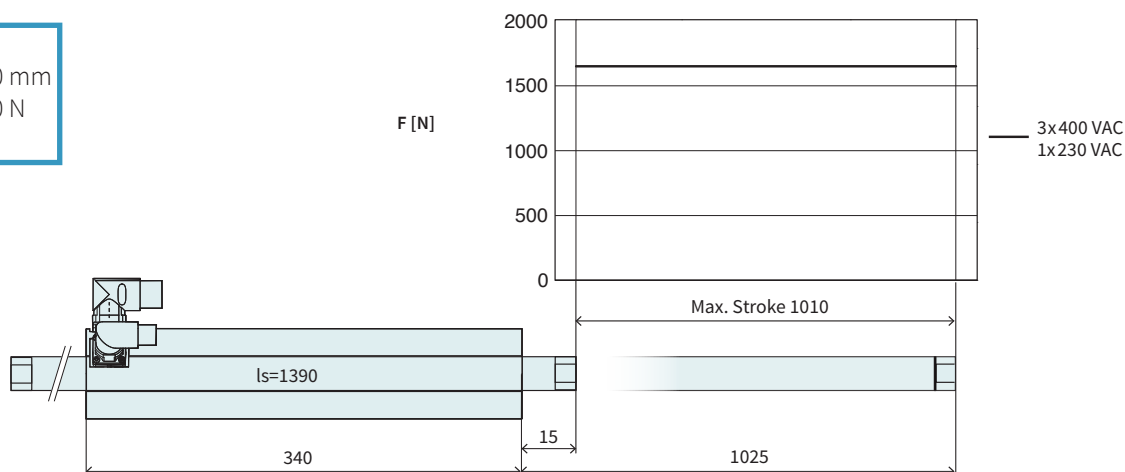

Dimensions in mm

Stroke			
Max. Stroke	mm (in)	1010 (39.79)	
Force			
Max. Force <sup>1</sup> @ 1x230VAC	N (lbf)	1650 (371)	
Max. Force <sup>1</sup> @ 3x400VAC	N (lbf)	1650 (371)	
Max. Cont. Force [Passive cooling/ Fan / Fluid]	N (lbf)	190 / 290 / 510 (43 / 66 / 120)	
Max. Border Force relative	%	100	
Force Constant 1	N/A <sub>pk</sub> (lbf/A <sub>pk</sub> )	59 (13.3)	
Force Constant 2	N/A <sub>rms</sub> (lbf/A <sub>rms</sub> )	83.4 (18.8)	
Velocity			
Max. Velocity @ 1x230VAC	m/s (in/s)	3 (119.9)	
Max. Velocity @ 3x400VAC	m/s (in/s)	5.4 (5.4)	
Position Detection			
Repeatability	mm (in)	±0.05 (±0.002)	
Linearity	%	± 0.15	
Electrical Data			
Max. Current <sup>1</sup> @ 1x230VAC	A <sub>pk</sub> / A <sub>rms</sub>	27.9 / 19.7	
Max. Current <sup>1</sup> @ 3x400VAC	A <sub>pk</sub> / A <sub>rms</sub>	27.9 / 19.7	
Max. Cont. Current 1 [Passive cooling / Fan / Fluid]	A <sub>pk</sub>	3.3 / 5 / 8.7	
Max. Cont. Current 2 [Passive cooling / Fan / Fluid]	A <sub>rms</sub>	2.3 / 3.5 / 6.1	
Thermal Data			
Max. Winding Temperature (Sensor)	°C	90	
Thermal Resistance [Passive cooling / Fan / Fluid]	°K/W	0.87 / 0.38 / 0.12	
Thermal Time Constant [Passive cooling / Fan / Fluid]	s	2100 / 510 / 110	
Mechanical Data			
Slider Length	mm (in)	1390 (55)	
Slider Mass	g (lb)	6530 (14.37)	

<sup>1</sup> Real time calculation of motor winding temperature is required (including monitoring).  
 If temperature monitoring is only based on temperature sensor signal (missing thermal model calculation), 60 % of the peak value has to be taken instead.



Item	Description	Item-No.
<b>PS10-70x240U-BL-QJ</b>	Stator 3x400VAC, LinMot Encoder	<a href="#">0150-1293</a>
<b>PS10-70x240U-BL-QJ-D04</b>	Stator 3x400VAC, Sin/Cos Encoder 1Vpp, Pt1000 dual	<a href="#">0150-4262</a>
<b>PS10-70x240U-BL-QJ-D05</b>	Stator 3x400VAC, Sin/Cos Encoder 1Vpp, PTC dual	<a href="#">0150-4607</a>
<b>PS10-70x240U-BL-QJ-D08</b>	Stator 3x400VAC, Sin/Cos Encoder 1Vpp, KTY dual	<a href="#">0150-4512</a>
<b>PS10-70x240U-BL-QJ-D24</b>	Stator 3x400VAC, A/B Encoder 1µm, Pt1000 dual	<a href="#">0150-4132</a>
<b>PS10-70x240U-BL-QJ-D24S</b>	Stator 3x400VAC, A/B Encoder 5µm, Pt1000 dual	<a href="#">0150-4597</a>
<b>PS10-70x240U-BL-QJ-D25</b>	Stator 3x400VAC, A/B Encoder 1µm, PTC dual	<a href="#">0150-5762</a>
<b>PS10-70x240U-BL-QJ-D25S</b>	Stator 3x400VAC, A/B Encoder 5µm, PTC dual	<a href="#">0150-4602</a>
<b>PS10-70x240U-BL-QJ-D26</b>	Stator 3x400VAC, A/B Encoder 1µm, PTC single ended	<a href="#">0150-4516</a>
<b>PS10-70x240U-BL-QJ-D34</b>	Stator 3x400VAC, BiSS-C, Pt1000 dual	<a href="#">0150-4872</a>
<b>PL10-28x1390/1340</b>	Slider for P10-70 'standard'	<a href="#">0150-2205</a>

**P10-70x240U/1210-BL-QJ**

**Max. Stroke:** 1210 mm  
**Peak Force:** 1650 N

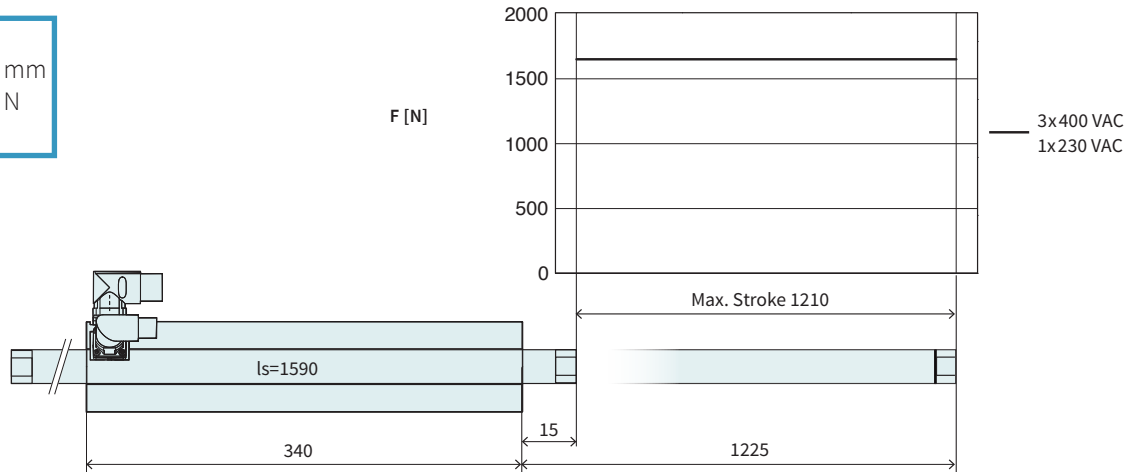

Dimensions in mm

Stroke			
Max. Stroke	mm (in)		1210 (47.6)
Force			
Max. Force <sup>1</sup> @ 1x230VAC	N (lbf)		1650 (371)
Max. Force <sup>1</sup> @ 3x400VAC	N (lbf)		1650 (371)
Max. Cont. Force [Passive cooling / Fan / Fluid]	N (lbf)		190 / 290 / 510 (43 / 66 / 120)
Max. Border Force relative	%		100
Force Constant 1	N/A <sub>pk</sub> (lbf/A <sub>pk</sub> )		59 (13.3)
Force Constant 2	N/A <sub>rms</sub> (lbf/A <sub>rms</sub> )		83.4 (18.8)
Velocity			
Max. Velocity @ 1x230VAC	m/s (in/s)		3 (119.9)
Max. Velocity @ 3x400VAC	m/s (in/s)		5.4 (5.4)
Position Detection			
Repeatability	mm (in)		±0.05 (±0.002)
Linearity	%		± 0.15
Electrical Data			
Max. Current <sup>1</sup> @ 1x230VAC	A <sub>pk</sub> / A <sub>rms</sub>		27.9 / 19.7
Max. Current <sup>1</sup> @ 3x400VAC	A <sub>pk</sub> / A <sub>rms</sub>		27.9 / 19.7
Max. Cont. Current 1 [Passive cooling / Fan / Fluid]	A <sub>pk</sub>		3.3 / 5 / 8.7
Max. Cont. Current 2 [Passive cooling / Fan / Fluid]	A <sub>rms</sub>		2.3 / 3.5 / 6.1
Thermal Data			
Max. Winding Temperature (Sensor)	°C		90
Thermal Resistance [Passive cooling / Fan / Fluid]	°K/W		0.87 / 0.38 / 0.12
Thermal Time Constant [Passive cooling / Fan / Fluid]	s		2100 / 510 / 110
Mechanical Data			
Slider Length	mm (in)		1590 (63)
Slider Mass	g (lb)		7470 (16.43)

1) Real time calculation of motor winding temperature is required (including monitoring).  
 If temperature monitoring is only based on temperature sensor signal (missing thermal model calculation), 60% of the peak value has to be taken instead.

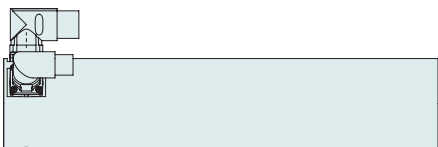

Item	Description	Item-No.
<b>PS10-70x240U-BL-QJ</b>	Stator 3x400VAC, LinMot Encoder	<a href="#">0150-1293</a>
<b>PS10-70x240U-BL-QJ-D04</b>	Stator 3x400VAC, Sin/Cos Encoder 1Vpp, Pt1000 dual	<a href="#">0150-4262</a>
<b>PS10-70x240U-BL-QJ-D05</b>	Stator 3x400VAC, Sin/Cos Encoder 1Vpp, PTC dual	<a href="#">0150-4607</a>
<b>PS10-70x240U-BL-QJ-D08</b>	Stator 3x400VAC, Sin/Cos Encoder 1Vpp, KTY dual	<a href="#">0150-4512</a>
<b>PS10-70x240U-BL-QJ-D24</b>	Stator 3x400VAC, A/B Encoder 1µm, Pt1000 dual	<a href="#">0150-4132</a>
<b>PS10-70x240U-BL-QJ-D24S</b>	Stator 3x400VAC, A/B Encoder 5µm, Pt1000 dual	<a href="#">0150-4597</a>
<b>PS10-70x240U-BL-QJ-D25</b>	Stator 3x400VAC, A/B Encoder 1µm, PTC dual	<a href="#">0150-5762</a>
<b>PS10-70x240U-BL-QJ-D25S</b>	Stator 3x400VAC, A/B Encoder 5µm, PTC dual	<a href="#">0150-4602</a>
<b>PS10-70x240U-BL-QJ-D26</b>	Stator 3x400VAC, A/B Encoder 1µm, PTC single ended	<a href="#">0150-4516</a>
<b>PS10-70x240U-BL-QJ-D34</b>	Stator 3x400VAC, BiSS-C, Pt1000 dual	<a href="#">0150-4872</a>
<b>PL10-28x1590/1540</b>	Slider for P10-70 'standard'	<a href="#">0150-2206</a>

**P10-70x240U/1410-BL-QJ**

**Max. Stroke:** 1410 mm  
**Peak Force:** 1650 N

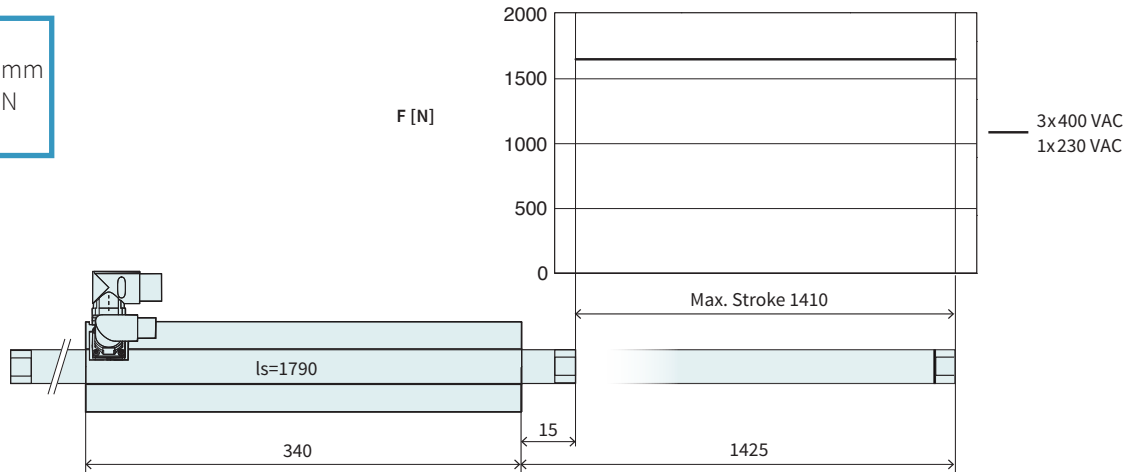

Dimensions in mm

Stroke			
Max. Stroke	mm (in)	1410 (55.49)	
Force			
Max. Force <sup>1</sup> @ 1x230VAC	N (lbf)	1650 (371)	
Max. Force <sup>1</sup> @ 3x400VAC	N (lbf)	1650 (371)	
Max. Cont. Force [Passive cooling/ Fan / Fluid]	N (lbf)	190 / 290 / 510 (43 / 66 / 120)	
Max. Border Force relative	%	100	
Force Constant 1	N/A <sub>pk</sub> (lbf/A <sub>pk</sub> )	59 (13.3)	
Force Constant 2	N/A <sub>rms</sub> (lbf/A <sub>rms</sub> )	83.4 (18.8)	
Velocity			
Max. Velocity @ 1x230VAC	m/s (in/s)	3 (119.9)	
Max. Velocity @ 3x400VAC	m/s (in/s)	5.4 (5.4)	
Position Detection			
Repeatability	mm (in)	±0.05 (±0.002)	
Linearity	%	± 0.15	
Electrical Data			
Max. Current <sup>1</sup> @ 1x230VAC	A <sub>pk</sub> / A <sub>rms</sub>	27.9 / 19.7	
Max. Current <sup>1</sup> @ 3x400VAC	A <sub>pk</sub> / A <sub>rms</sub>	27.9 / 19.7	
Max. Cont. Current 1 [Passive cooling / Fan / Fluid]	A <sub>pk</sub>	3.3 / 5 / 8.7	
Max. Cont. Current 2 [Passive cooling / Fan / Fluid]	A <sub>rms</sub>	2.3 / 3.5 / 6.1	
Thermal Data			
Max. Winding Temperature (Sensor)	°C	90	
Thermal Resistance [Passive cooling / Fan / Fluid]	°K/W	0.87 / 0.38 / 0.12	
Thermal Time Constant [Passive cooling / Fan / Fluid]	s	2100 / 510 / 110	
Mechanical Data			
Slider Length	mm (in)	1790 (70)	
Slider Mass	g (lb)	8413 (18.51)	

<sup>1</sup> Real time calculation of motor winding temperature is required (including monitoring).  
 If temperature monitoring is only based on temperature sensor signal (missing thermal model calculation), 60 % of the peak value has to be taken instead.



Item	Description	Item-No.
<b>PS10-70x240U-BL-QJ</b>	Stator 3x400VAC, LinMot Encoder	<a href="#">0150-1293</a>
<b>PS10-70x240U-BL-QJ-D04</b>	Stator 3x400VAC, Sin/Cos Encoder 1Vpp, Pt1000 dual	<a href="#">0150-4262</a>
<b>PS10-70x240U-BL-QJ-D05</b>	Stator 3x400VAC, Sin/Cos Encoder 1Vpp, PTC dual	<a href="#">0150-4607</a>
<b>PS10-70x240U-BL-QJ-D08</b>	Stator 3x400VAC, Sin/Cos Encoder 1Vpp, KTY dual	<a href="#">0150-4512</a>
<b>PS10-70x240U-BL-QJ-D24</b>	Stator 3x400VAC, A/B Encoder 1µm, Pt1000 dual	<a href="#">0150-4132</a>
<b>PS10-70x240U-BL-QJ-D24S</b>	Stator 3x400VAC, A/B Encoder 5µm, Pt1000 dual	<a href="#">0150-4597</a>
<b>PS10-70x240U-BL-QJ-D25</b>	Stator 3x400VAC, A/B Encoder 1µm, PTC dual	<a href="#">0150-5762</a>
<b>PS10-70x240U-BL-QJ-D25S</b>	Stator 3x400VAC, A/B Encoder 5µm, PTC dual	<a href="#">0150-4602</a>
<b>PS10-70x240U-BL-QJ-D26</b>	Stator 3x400VAC, A/B Encoder 1µm, PTC single ended	<a href="#">0150-4516</a>
<b>PS10-70x240U-BL-QJ-D34</b>	Stator 3x400VAC, BiSS-C, Pt1000 dual	<a href="#">0150-4872</a>
<b>PL10-28x1790/1740</b>	Slider for P10-70 'standard'	<a href="#">0150-2207</a>

**P10-70x240U/1610-BL-QJ**

**Max. Stroke:** 1610 mm  
**Peak Force:** 1650 N

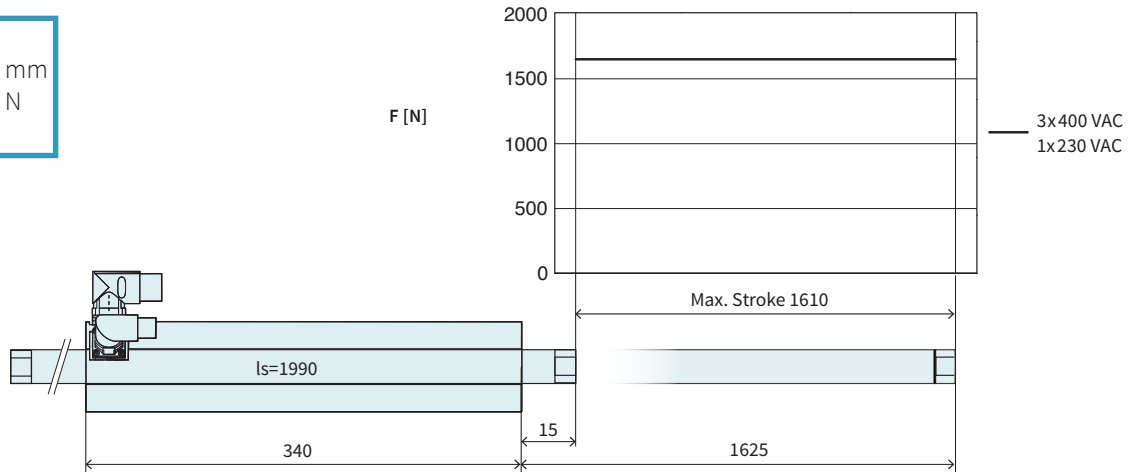

Dimensions in mm

Stroke			
Max. Stroke	mm (in)		1610 (63.39)
Force			
Max. Force <sup>1</sup> @ 1x230VAC	N (lbf)		1650 (371)
Max. Force <sup>1</sup> @ 3x400VAC	N (lbf)		1650 (371)
Max. Cont. Force [Passive cooling / Fan / Fluid]	N (lbf)		190 / 290 / 510 (43 / 66 / 120)
Max. Border Force relative	%		100
Force Constant 1	N/A <sub>pk</sub> (lbf/A <sub>pk</sub> )		59 (13.3)
Force Constant 2	N/A <sub>rms</sub> (lbf/A <sub>rms</sub> )		83.4 (18.8)
Velocity			
Max. Velocity @ 1x230VAC	m/s (in/s)		3 (119.9)
Max. Velocity @ 3x400VAC	m/s (in/s)		5.4 (5.4)
Position Detection			
Repeatability	mm (in)		±0.05 (±0.002)
Linearity	%		± 0.15
Electrical Data			
Max. Current <sup>1</sup> @ 1x230VAC	A <sub>pk</sub> / A <sub>rms</sub>		27.9 / 19.7
Max. Current <sup>1</sup> @ 3x400VAC	A <sub>pk</sub> / A <sub>rms</sub>		27.9 / 19.7
Max. Cont. Current 1 [Passive cooling / Fan / Fluid]	A <sub>pk</sub>		3.3 / 5 / 8.7
Max. Cont. Current 2 [Passive cooling / Fan / Fluid]	A <sub>rms</sub>		2.3 / 3.5 / 6.1
Thermal Data			
Max. Winding Temperature (Sensor)	°C		90
Thermal Resistance [Passive cooling / Fan / Fluid]	°K/W		0.87 / 0.38 / 0.12
Thermal Time Constant [Passive cooling / Fan / Fluid]	s		2100 / 510 / 110
Mechanical Data			
Slider Length	mm (in)		1990 (78)
Slider Mass	g (lb)		9350 (20.57)

1) Real time calculation of motor winding temperature is required (including monitoring).  
 If temperature monitoring is only based on temperature sensor signal (missing thermal model calculation), 60% of the peak value has to be taken instead.

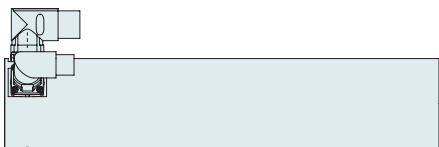

Item	Description	Item-No.
<b>PS10-70x240U-BL-QJ</b>	Stator 3x400VAC, LinMot Encoder	<a href="#">0150-1293</a>
<b>PS10-70x240U-BL-QJ-D04</b>	Stator 3x400VAC, Sin/Cos Encoder 1Vpp, Pt1000 dual	<a href="#">0150-4262</a>
<b>PS10-70x240U-BL-QJ-D05</b>	Stator 3x400VAC, Sin/Cos Encoder 1Vpp, PTC dual	<a href="#">0150-4607</a>
<b>PS10-70x240U-BL-QJ-D08</b>	Stator 3x400VAC, Sin/Cos Encoder 1Vpp, KTY dual	<a href="#">0150-4512</a>
<b>PS10-70x240U-BL-QJ-D24</b>	Stator 3x400VAC, A/B Encoder 1µm, Pt1000 dual	<a href="#">0150-4132</a>
<b>PS10-70x240U-BL-QJ-D24S</b>	Stator 3x400VAC, A/B Encoder 5µm, Pt1000 dual	<a href="#">0150-4597</a>
<b>PS10-70x240U-BL-QJ-D25</b>	Stator 3x400VAC, A/B Encoder 1µm, PTC dual	<a href="#">0150-5762</a>
<b>PS10-70x240U-BL-QJ-D25S</b>	Stator 3x400VAC, A/B Encoder 5µm, PTC dual	<a href="#">0150-4602</a>
<b>PS10-70x240U-BL-QJ-D26</b>	Stator 3x400VAC, A/B Encoder 1µm, PTC single ended	<a href="#">0150-4516</a>
<b>PS10-70x240U-BL-QJ-D34</b>	Stator 3x400VAC, BiSS-C, Pt1000 dual	<a href="#">0150-4872</a>
<b>PL10-28x1990/1940</b>	Slider for P10-70 'standard'	<a href="#">0150-2208</a>

**Linear Guides H10**



**HM10-70x240/110 | Linear Module 70x240 with 110 mm Stroke**

→	H-Guide	H10-70x240/110	H-Guide for P10-70x240, Stroke max. 110 mm	<a href="#">0150-5185</a>	
	→	Stator	PS10-70x240U-BL-QJ	Stator 3x400VAC, LinMot Encoder	<a href="#">0150-1293</a>
			PS10-70x240U-BL-QJ-D04	Stator 3x400VAC, Sin/Cos Encoder 1Vpp, Pt1000 dual	<a href="#">0150-4262</a>
			PS10-70x240U-BL-QJ-D05	Stator 3x400VAC, Sin/Cos Encoder 1Vpp, PTC dual	<a href="#">0150-4607</a>
			PS10-70x240U-BL-QJ-D08	Stator 3x400VAC, Sin/Cos Encoder 1Vpp, KTY dual	<a href="#">0150-4512</a>
			PS10-70x240U-BL-QJ-D24	Stator 3x400VAC, A/B Encoder 1µm, Pt1000 dual	<a href="#">0150-4132</a>
			PS10-70x240U-BL-QJ-D24S	Stator 3x400VAC, A/B Encoder 5µm, Pt1000 dual	<a href="#">0150-4597</a>
			PS10-70x240U-BL-QJ-D25	Stator 3x400VAC, A/B Encoder 1µm, PTC dual	<a href="#">0150-5762</a>
			PS10-70x240U-BL-QJ-D25S	Stator 3x400VAC, A/B Encoder 5µm, PTC dual	<a href="#">0150-4602</a>
			PS10-70x240U-BL-QJ-D26	Stator 3x400VAC, A/B Encoder 1µm, PTC single ended	<a href="#">0150-4516</a>
	PS10-70x240U-BL-QJ-D34	Stator 3x400VAC, BiSS-C, Pt1000 dual	<a href="#">0150-4872</a>		
→	Slider	PL10-28x490/440	Slider for P10-70 'standard'	<a href="#">0150-2195</a>	

**HM10-70x240/210 | Linear Module 70x240 with 210 mm Stroke**

→	H-Guide	H10-70x240/210	H-Guide for P10-70x240, Stroke max. 210 mm	<a href="#">0150-5400</a>	
	→	Stator	PS10-70x240U-BL-QJ	Stator 3x400VAC, LinMot Encoder	<a href="#">0150-1293</a>
			PS10-70x240U-BL-QJ-D04	Stator 3x400VAC, Sin/Cos Encoder 1Vpp, Pt1000 dual	<a href="#">0150-4262</a>
			PS10-70x240U-BL-QJ-D05	Stator 3x400VAC, Sin/Cos Encoder 1Vpp, PTC dual	<a href="#">0150-4607</a>
			PS10-70x240U-BL-QJ-D08	Stator 3x400VAC, Sin/Cos Encoder 1Vpp, KTY dual	<a href="#">0150-4512</a>
			PS10-70x240U-BL-QJ-D24	Stator 3x400VAC, A/B Encoder 1µm, Pt1000 dual	<a href="#">0150-4132</a>
			PS10-70x240U-BL-QJ-D24S	Stator 3x400VAC, A/B Encoder 5µm, Pt1000 dual	<a href="#">0150-4597</a>
			PS10-70x240U-BL-QJ-D25	Stator 3x400VAC, A/B Encoder 1µm, PTC dual	<a href="#">0150-5762</a>
			PS10-70x240U-BL-QJ-D25S	Stator 3x400VAC, A/B Encoder 5µm, PTC dual	<a href="#">0150-4602</a>
			PS10-70x240U-BL-QJ-D26	Stator 3x400VAC, A/B Encoder 1µm, PTC single ended	<a href="#">0150-4516</a>
			PS10-70x240U-BL-QJ-D34	Stator 3x400VAC, BiSS-C, Pt1000 dual	<a href="#">0150-4872</a>
→	Slider	PL10-28x590/540	Slider for P10-70 'standard'	<a href="#">0150-2196</a>	

HM10-70x240/310		Linear Module 70x240 with 310 mm Stroke		
→	H-Guide	H10-70x240/310	H-Guide for P10-70x240, Stroke max. 310 mm	<a href="#">0150-5401</a>
→	Stator	PS10-70x240U-BL-QJ	Stator 3x400VAC, LinMot Encoder	<a href="#">0150-1293</a>
		PS10-70x240U-BL-QJ-D04	Stator 3x400VAC, Sin/Cos Encoder 1Vpp, Pt1000 dual	<a href="#">0150-4262</a>
		PS10-70x240U-BL-QJ-D05	Stator 3x400VAC, Sin/Cos Encoder 1Vpp, PTC dual	<a href="#">0150-4607</a>
		PS10-70x240U-BL-QJ-D08	Stator 3x400VAC, Sin/Cos Encoder 1Vpp, KTY dual	<a href="#">0150-4512</a>
		PS10-70x240U-BL-QJ-D24	Stator 3x400VAC, A/B Encoder 1µm, Pt1000 dual	<a href="#">0150-4132</a>
		PS10-70x240U-BL-QJ-D24S	Stator 3x400VAC, A/B Encoder 5µm, Pt1000 dual	<a href="#">0150-4597</a>
		PS10-70x240U-BL-QJ-D25	Stator 3x400VAC, A/B Encoder 1µm, PTC dual	<a href="#">0150-5762</a>
		PS10-70x240U-BL-QJ-D25S	Stator 3x400VAC, A/B Encoder 5µm, PTC dual	<a href="#">0150-4602</a>
		PS10-70x240U-BL-QJ-D26	Stator 3x400VAC, A/B Encoder 1µm, PTC single ended	<a href="#">0150-4516</a>
		PS10-70x240U-BL-QJ-D34	Stator 3x400VAC, BiSS-C, Pt1000 dual	<a href="#">0150-4872</a>
→	Slider	PL10-28x690/640	Slider for P10-70 'standard'	<a href="#">0150-2197</a>

HM10-70x240/410		Linear Module 70x240 with 410 mm Stroke		
→	H-Guide	H10-70x240/410	H-Guide for P10-70x240, Stroke max. 410 mm	<a href="#">0150-5402</a>
→	Stator	PS10-70x240U-BL-QJ	Stator 3x400VAC, LinMot Encoder	<a href="#">0150-1293</a>
		PS10-70x240U-BL-QJ-D04	Stator 3x400VAC, Sin/Cos Encoder 1Vpp, Pt1000 dual	<a href="#">0150-4262</a>
		PS10-70x240U-BL-QJ-D05	Stator 3x400VAC, Sin/Cos Encoder 1Vpp, PTC dual	<a href="#">0150-4607</a>
		PS10-70x240U-BL-QJ-D08	Stator 3x400VAC, Sin/Cos Encoder 1Vpp, KTY dual	<a href="#">0150-4512</a>
		PS10-70x240U-BL-QJ-D24	Stator 3x400VAC, A/B Encoder 1µm, Pt1000 dual	<a href="#">0150-4132</a>
		PS10-70x240U-BL-QJ-D24S	Stator 3x400VAC, A/B Encoder 5µm, Pt1000 dual	<a href="#">0150-4597</a>
		PS10-70x240U-BL-QJ-D25	Stator 3x400VAC, A/B Encoder 1µm, PTC dual	<a href="#">0150-5762</a>
		PS10-70x240U-BL-QJ-D25S	Stator 3x400VAC, A/B Encoder 5µm, PTC dual	<a href="#">0150-4602</a>
		PS10-70x240U-BL-QJ-D26	Stator 3x400VAC, A/B Encoder 1µm, PTC single ended	<a href="#">0150-4516</a>
		PS10-70x240U-BL-QJ-D34	Stator 3x400VAC, BiSS-C, Pt1000 dual	<a href="#">0150-4872</a>
→	Slider	PL10-28x790/740	Slider for P10-70 'standard'	<a href="#">0150-2198</a>

HM10-70x240/510		Linear Module 70x240 with 510 mm Stroke		
→	H-Guide	H10-70x240/510	H-Guide for P10-70x240, Stroke max. 510 mm	<a href="#">0150-5403</a>
→	Stator	PS10-70x240U-BL-QJ	Stator 3x400VAC, LinMot Encoder	<a href="#">0150-1293</a>
		PS10-70x240U-BL-QJ-D04	Stator 3x400VAC, Sin/Cos Encoder 1Vpp, Pt1000 dual	<a href="#">0150-4262</a>
		PS10-70x240U-BL-QJ-D05	Stator 3x400VAC, Sin/Cos Encoder 1Vpp, PTC dual	<a href="#">0150-4607</a>
		PS10-70x240U-BL-QJ-D08	Stator 3x400VAC, Sin/Cos Encoder 1Vpp, KTY dual	<a href="#">0150-4512</a>
		PS10-70x240U-BL-QJ-D24	Stator 3x400VAC, A/B Encoder 1µm, Pt1000 dual	<a href="#">0150-4132</a>
		PS10-70x240U-BL-QJ-D24S	Stator 3x400VAC, A/B Encoder 5µm, Pt1000 dual	<a href="#">0150-4597</a>
		PS10-70x240U-BL-QJ-D25	Stator 3x400VAC, A/B Encoder 1µm, PTC dual	<a href="#">0150-5762</a>
		PS10-70x240U-BL-QJ-D25S	Stator 3x400VAC, A/B Encoder 5µm, PTC dual	<a href="#">0150-4602</a>
		PS10-70x240U-BL-QJ-D26	Stator 3x400VAC, A/B Encoder 1µm, PTC single ended	<a href="#">0150-4516</a>
		PS10-70x240U-BL-QJ-D34	Stator 3x400VAC, BiSS-C, Pt1000 dual	<a href="#">0150-4872</a>
→	Slider	PL10-28x890/840	Slider for P10-70 'standard'	<a href="#">0150-2199</a>

Accessories				
→	Fan	HV01-37/48	Fan cooling for H01-37/48 & PF02-37/48	<a href="#">0150-5051</a>

**Motor Cable**

4



**C1400**

**B** Connector MC10-B/m

**Q** Connector MC10-Q/f

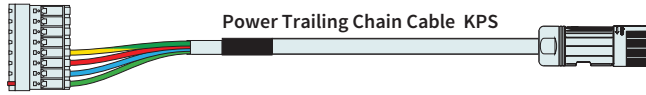

Power Trailing Chain Cable KPS

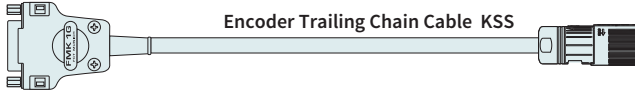

Encoder Trailing Chain Cable KSS



**P10-70x240U**

**D15** Connector MC01-D15/f

**J** Connector MC10-J/f



**E1400**

**L** Connector MC10-L/m

**Q** Connector MC10-Q/f

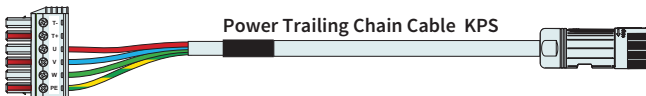

Power Trailing Chain Cable KPS

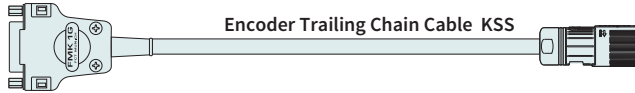

Encoder Trailing Chain Cable KSS

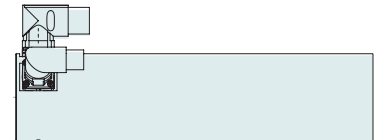

**P10-70x240U**

**D15** Connector MC01-D15/f

**J** Connector MC10-J/f

## ORDERING INFORMATION

POWER CABLES		
Item	Description	Item-No.
<b>KPS15-04-L/Q-3</b>	Power Trailing Chain Cable E1400/P10-70, 3 m	<a href="#">0150-2266</a>
<b>KPS15-04-L/Q-5</b>	Power Trailing Chain Cable E1400/P10-70, 5 m	<a href="#">0150-2261</a>
<b>KPS15-04-L/Q-8</b>	Power Trailing Chain Cable E1400/P10-70, 8 m	<a href="#">0150-2267</a>
<b>KPS15-04-L/Q-12</b>	Power Trailing Chain Cable E1400/P10-70, 12 m	<a href="#">0150-2268</a>
<b>KPS15-04-L/Q-</b>	Power Trailing Chain Cable L/Q-, Custom length	<a href="#">0150-3388</a>
<b>KPS15-04-B/Q-3</b>	Power Trailing Chain Cable C1400/P10-70, 3 m	<a href="#">0150-3660</a>
<b>KPS15-04-B/Q-5</b>	Power Trailing Chain Cable C1400/P10-70, 5 m	<a href="#">0150-3661</a>
<b>KPS15-04-B/Q-8</b>	Power Trailing Chain Cable C1400/P10-70, 8 m	<a href="#">0150-3662</a>
<b>KPS15-04-B/Q-12</b>	Power Trailing Chain Cable C1400/P10-70, 12 m	<a href="#">0150-3663</a>
<b>KPS15-04-B/Q-</b>	Power Trailing Chain Cable B/Q-, Custom length	<a href="#">0150-3608</a>
ENCODER CABLES		
Item	Description	Item-No.
<b>KSS05-02/08-D15/J-3</b>	Encoder Trailing Chain Cable D15/J, 3 m	<a href="#">0150-2263</a>
<b>KSS05-02/08-D15/J-5</b>	Encoder Trailing Chain Cable D15/J, 5 m	<a href="#">0150-2262</a>
<b>KSS05-02/08-D15/J-8</b>	Encoder Trailing Chain Cable D15/J, 8 m	<a href="#">0150-2264</a>
<b>KSS05-02/08-D15/J-12</b>	Encoder Trailing Chain Cable D15/J, 12 m	<a href="#">0150-2265</a>
<b>KSS05-02/08-D15(f)-45°/J-</b>	Encoder Trailing Chain Cable D15/J-, Custom length	<a href="#">0150-3389</a>
EXTENSION CABLES		
Item	Description	Item-No.
<b>KPS15-04-Q/Q-</b>	Power Trailing Chain Cable Q/Q-, Custom length	<a href="#">0150-3414</a>
<b>KSS05-02/08-J/J-</b>	Encoder Trailing Chain Cable J/J-, Custom length	<a href="#">0150-3415</a>
CONNECTORS		
Item	Description	Item-No.
<b>MC10-L/m</b>	Connector Power E1400/X2	<a href="#">0150-3382</a>
<b>MC01-D15/f</b>	Motor Connector D15 (f)	<a href="#">0150-3136</a>
<b>MC10-Q/f</b>	Connector Power PS10-70	<a href="#">0150-2268</a>
<b>MC10-J/f</b>	Connector Encoder PS10-70	<a href="#">0150-2269</a>

**Motor Cables for 3rd Party Drives**

4

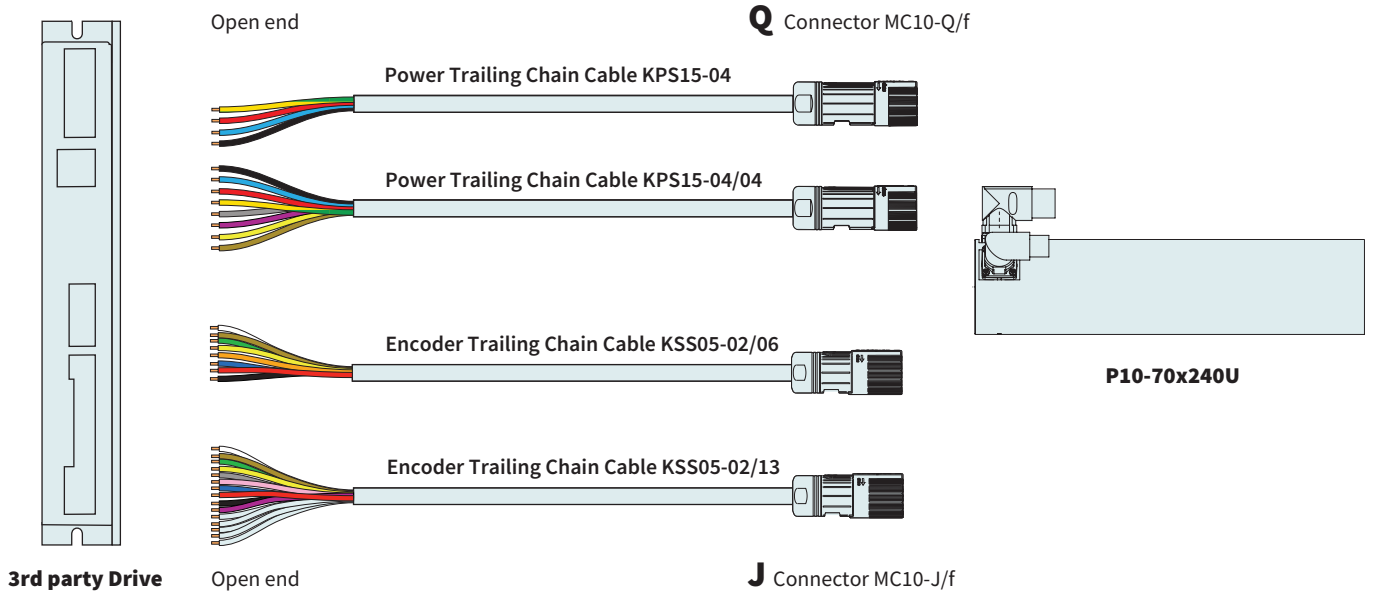

ORDER OVERVIEW							
Motor-Interface	Power Cable		Encoder Cable				
		TempFeedback		TempFeedback	Hallswitch Signals	Reference Signal	PosFeedback
D04 / D05 / D08	KPS15-04-_/Q-...	---	KSS05-02/13-_/J-...	Pt1000 / PTC / KTY	Hall U/V/W	Ref	Sin/Cos
	KPS15-04/04-_/Q-...	Pt1000 / PTC / KTY	KSS05-02/06-_/J-...	---	---	---	
D24(S) / D25(S) / D26	KPS15-04-_/Q-...	---	KSS05-02/13-_/J-...	Pt1000 / PTC	Hall U/V/W	Ref	AB 1 µm (5 µm)
	KPS15-04/04-_/Q-...	Pt1000 / PTC	KSS05-02/06-_/J-...	---	---	---	
D34	KPS15-04-_/Q-...	---	KSS05-02/13-_/J-...	Pt1000	Hall U/V/W	Ref	BiSS-C
	KPS15-04/04-_/Q-...	Pt1000					

## ORDERING INFORMATION

POWER CABLES		
Item	Description	Item-No.
<b>KPS15-04-.../Q-10</b>	Power Trailing Chain Cable .../Q, 10 m for Dxx	<a href="#">0150-2376</a>
<b>KPS15-04-./Q-</b>	Power Trailing Chain Cable .../Q, für Dxx, Custom length	<a href="#">0150-3491</a>
<b>KPS15-04</b>	Power Trailing Chain Cable P10-70 (per m)	<a href="#">0150-2257</a>
<b>KPS15-04/04.../Q-10</b>	Power Trailing Chain Cable .../Q, 10 m for Dxx	<a href="#">0150-3654</a>
<b>KPS15-04/04-./Q-</b>	Power Trailing Chain Cable .../Q, für Dxx, Custom length	<a href="#">0150-3579</a>
<b>KPS15-04/04</b>	Power Trailing Chain Cable P10-...-Dxx (per m)	<a href="#">0150-2269</a>

ENCODER CABLES		
Item	Description	Item-No.
<b>KSS05-02/13-.../J-10</b>	Encoder Trailing Chain Cable .../J, 10 m for Dxx	<a href="#">0150-2377</a>
<b>KSS05-02/13-./J-</b>	Encoder Trailing Chain Cable ./J, für Dxx, Custom length	<a href="#">0150-3492</a>
<b>KSS05-02/13</b>	Encoder Trailing Chain Cable P10-...-Dxx (per m)	<a href="#">0150-2259</a>

EXTENSION CABLES		
Item	Description	Item-No.
<b>KPS15-04-Q/Q-</b>	Power Trailing Chain Cable Q/Q-, Custom length	<a href="#">0150-3414</a>
<b>KPS15-04/04-Q/Q-</b>	Power Trailing Chain Cable Q/Q-, Custom length	<a href="#">0150-4214</a>
<b>KSS05-02/13-J/J-</b>	Encoder Trailing Chain Cable J/J, für Dxx, Custom length	<a href="#">0150-3996</a>

CONNECTORS		
Item	Description	Item-No.
<b>MC10-Q/f</b>	Connector Power PS10-70	<a href="#">0150-2268</a>
<b>MC10-J/f</b>	Connector Encoder PS10-70	<a href="#">0150-2269</a>

**MOTOR FLANGES**

4



Item	Description	Item-No.
PF10-70x270	Flange for PS10-70x240	<a href="#">0150-2274</a>



Item	Description	Item-No.
PF11-70x270-FC	Flange for PS10-70x240 fluid cooling	<a href="#">0150-2824</a>

FIND MORE PRODUCT DETAILS IN THE CHAPTER "ACCESSORIES".

**FANS**



Item	Description	Item-No.
HV01-37/48	Fan cooling for H01-37/48 & PF02-37/48	<a href="#">0150-5051</a>

FIND MORE PRODUCT DETAILS IN THE CHAPTER "ACCESSORIES".

**SLIDER MOUNTING**



Item	Description	Item-No.
<b>PLF01-28</b>	Fixed Bearing Set for 27/28 mm sliders	<a href="#">0150-3087</a>
<b>PLF01-28-SS</b>	Fixed Bearing Set for 27/28 mm sliders, stainless steel	<a href="#">0150-3297</a>
<b>PLL01-28</b>	Floating Bearing for 28 mm sliders	<a href="#">0150-3094</a>
<b>PLM01-28-MK</b>	Mounting Kit for 28 mm sliders	<a href="#">0150-3095</a>

FIND MORE PRODUCT DETAILS IN THE CHAPTER "ACCESSORIES".

**BEARING KIT**



Item	Description	Item-No.
<b>PB10-70x240-L</b>	Bearing Kit for PS10-70x240	<a href="#">0150-3433</a>

FIND MORE PRODUCT DETAILS IN THE CHAPTER "ACCESSORIES".

**LUBRICANT RESERVOIR**



Item	Description	Item-No.
<b>PA10-70/28</b>	Lubricant reservoir for PS10-70 with lubricating nipple	<a href="#">0150-3543</a>

FIND MORE PRODUCT DETAILS IN THE CHAPTER "ACCESSORIES".

**EXTERNAL POSITION SENSORS**

4

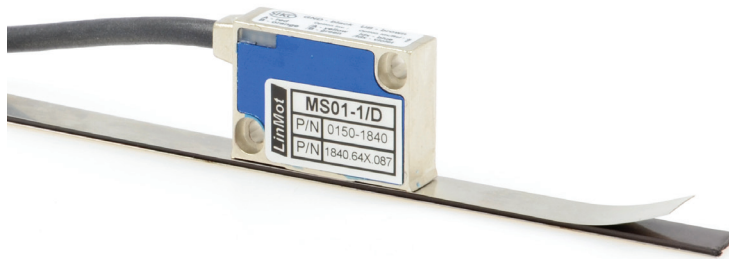

Item	Description	Item-No.
<b>MS01-1/D</b>	Linear Encoder 1µm, A/B (for incremental strip)	<a href="#">0150-1840</a>
<b>MB01-1000</b>	Magnetic incremental strip for MS01-1/D, per cm	<a href="#">0150-1963</a>
<b>KS025-D15/D-Encoder</b>	Encoder Cable (Length in m)	<a href="#">0150-3168</a>

FIND MORE PRODUCT DETAILS IN THE CHAPTER "ACCESSORIES".



Item	Description	Item-No.
<b>MS01-1/D-SSI</b>	Linear Encoder 1µm, A/B (for absolute strip)	<a href="#">0150-2095</a>
<b>MB01-1000-ABS</b>	Magnetic absolute strip for MS01-1/D-SSI (per cm)	<a href="#">0150-2096</a>
<b>EC01-ABS/ENC-12-S</b>	MS01-1/D-SSI Encoder connector straight	<a href="#">0150-3616</a>
<b>KSS01-12-D15/ABS-ENC</b>	Special cable for MS01-1/D-SSI on C1100/C1200/C1400/E1200/E1400 Drives	<a href="#">0150-3652</a>

FIND MORE PRODUCT DETAILS IN THE CHAPTER "ACCESSORIES".

Area with horizontal dotted lines for notes.