

LINEAR MOTORS P10-70X240U

4

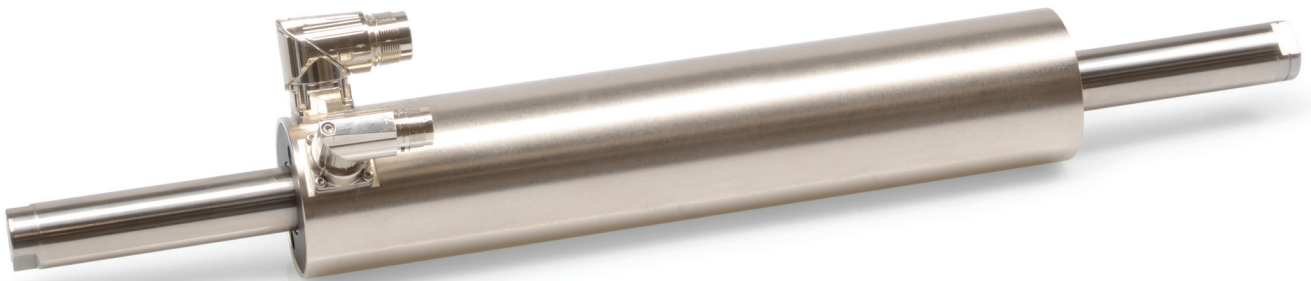

- ✓ 3 x 400VAC technology
- ✓ Peak forces up to 1650 N
- ✓ LinMot encoder or 3rd party drive encoder
SinCos, A/B incremental, BiSS / PT1000, PTC
- ✓ Extremely high dynamic
- ✓ Separate connector for sensor and power cable
- ✓ Can also be controlled by standard third-party servo drives

LINEAR MOTORS P10-70X240U

/ TECHNICAL DATA /	562
/ MOTOR SPECIFICATIONS /	576
P10-70x240U/10-BL-QJ.....	576
P10-70x240U/110-BL-QJ.....	577
P10-70x240U/210-BL-QJ.....	578
P10-70x240U/310-BL-QJ.....	579
P10-70x240U/410-BL-QJ.....	580
P10-70x240U/510-BL-QJ.....	581
P10-70x240U/610-BL-QJ.....	582
P10-70x240U/810-BL-QJ.....	583
P10-70x240U/1010-BL-QJ	584
P10-70x240U/1210-BL-QJ	585
P10-70x240U/1410-BL-QJ	586
P10-70x240U/1610-BL-QJ	587
/ LINEAR GUIDES /	588
/ ACCESSORIES /	590



MOTOR FAMILY P10-70x240U

Technical Data

Stroke				
Max. Stroke (ES)	mm	(in)	1610	(63.39)
Force				
Max. Force ¹ @ 1x230VAC	N	(lbf)	1650	(371)
Max. Force ¹ @ 3x400VAC	N	(lbf)	1650	(371)
Max. Cont. Force [Passive cooling / Fan / Fluid]	N	(lbf)	190 / 290 / 510	(43 / 66 / 120)
Max. Border Force relative	%		100	
Force Constant 1	N/A _{pk}	(lbf/A _{pk})	59	(13.3)
Force Constant 2	N/A _{rms}	(lbf/A _{rms})	83.4	(18.8)
Velocity				
Max. Velocity @ 1x230VAC	m/s	(in/s)	3	(119.9)
Max. Velocity @ 3x400VAC	m/s	(in/s)	5.4	(209.9)
Position Detection				
Position Resolution	mm	(in)	0.005	(0.0002)
Repeatability	mm	(in)	±0.05	(±0.002)
Position Resolution with ES	mm	(in)	0.001	(0.00004)
Repeatability with ES	mm	(in)	±0.01	(±0.0004)
Linearity with ES	mm	(in)	±0.01	(±0.0004)
Electrical Data				
Max. Current ¹ @ 1x230VAC	A _{pk} / A _{rms}		27.9 / 19.7	
Max. Current ¹ @ 3x400VAC	A _{pk} / A _{rms}		27.9 / 19.7	
Max. Cont. Current 1 [Passive cooling / Fan / Fluid]	A _{pk}		3.3 / 5 / 8.7	
Max. Cont. Current 2 [Passive cooling / Fan / Fluid]	A _{rms}		2.3 / 3.5 / 6.1	
Back EMF Constant	V _{pk} / (m/s)	(V _{pk} / (in/s))	68.1	(1.73)
Terminal Resistance 25 °C / 120 °C	Ohm		6.3 / 8.6	
Terminal Inductivity	mH		12	
Magnetic Period	mm	(in)	40	(1.57)
Thermal Data				
Max. Winding Temperature (Sensor)	°C		90	
Thermal Resistance [Passive cooling / Fan / Fluid]	°K/W		0.87 / 0.38 / 0.12	
Thermal Time Constant [Passive cooling / Fan / Fluid]	s		2100 / 510 / 110	
Mechanical Data				
Stator Diameter	mm	(in)	70	(2.8)
Stator Length	mm	(in)	340	(13)
Stator Mass	g	(lb)	5550	(12.21)
Slider Diameter	mm	(in)	28	(1.1)
Slider Length	mm	(in)	390 - 1990	(15 - 78)
Slider Mass	g	(lb)	1830 - 9350	(4.03 - 20.57)
IP Code			IP 65	
Certification				
UL	File-No.		E354430	

¹ Real time calculation of motor winding temperature is required (including monitoring).

If temperature monitoring is only based on temperature sensor signal (missing thermal model calculation), 60 % of the peak value has to be taken instead.

STATOR

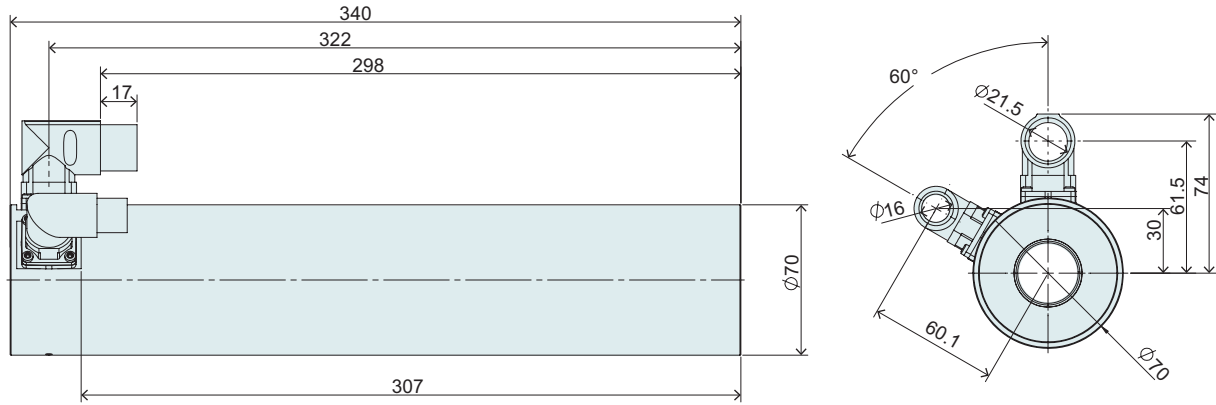

Item	Description	Item-No.	Comment
PS10-70x240U-BL-QJ	Stator 3x400VAC, LinMot Encoder	0150-1293	For use with LinMot Drives
PS10-70x240U-BL-QJ-D04	Stator 3x400VAC, Sin/Cos Encoder 1Vpp, Pt1000 dual	0150-4262	For use with 3rd Party Drives
PS10-70x240U-BL-QJ-D05	Stator 3x400VAC, Sin/Cos Encoder 1Vpp, PTC dual	0150-4607	For use with 3rd Party Drives
PS10-70x240U-BL-QJ-D24	Stator 3x400VAC, A/B Encoder 1µm, Pt1000 dual	0150-4132	For use with 3rd Party Drives
PS10-70x240U-BL-QJ-D24S	Stator 3x400VAC, A/B Encoder 5µm, Pt1000 dual	0150-4597	For use with 3rd Party Drives
PS10-70x240U-BL-QJ-D25	Stator 3x400VAC, A/B Encoder 1µm, PTC dual	0150-5762	For use with 3rd Party Drives
PS10-70x240U-BL-QJ-D25S	Stator 3x400VAC, A/B Encoder 5µm, PTC dual	0150-4602	For use with 3rd Party Drives
PS10-70x240U-BL-QJ-D26	Stator 3x400VAC, A/B Encoder 1µm, PTC single ended	0150-4516	For use with 3rd Party Drives
PS10-70x240U-BL-QJ-D34	Stator 3x400VAC, BiSS-C, Pt1000 dual	0150-4872	For use with 3rd Party Drives

AVAILABLE INTERFACES FOR 3RD PARTY DRIVES

TEMPERATURE FEEDBACK		POSITION FEEDBACK			
		SinCos, 1Vpp	A/B 1µm	A/B 5µm	BiSS-C
		D0x	D2x	D2xS	D3x
MotLink C					
Pt1000, dual*	Dx4	D04		D24S	D34
PTC, dual*	Dx5	D05		D25S	
PTC single ended	Dx6		D26		

* Feedback available on encoder and power connectors.

CONNECTOR PS10-70x240U-BL-QJ (INTERFACE FOR LINMOT DRIVES)

Motor Connector Wiring		Connector Encoder J	Wire Color Cable KSS05-02/08
+5VDC*	Supply	1	red
GND	Supply	2	black
Sense +5V*	Supply Sense	3	white
Sense GND*	Supply Sense	4	brown
Mot. Link C+	Communication	5	pink
Mot. Link C-	Communication	6	grey
Sin+	Encoder	7	yellow
Sin-	Encoder	8	orange
Cos+	Encoder	9	green
Cos-	Encoder	10	blue
n. c.	n. c.	11	n. c.
n. c.	n. c.	12	n. c.
n. c.	n. c.	13	n. c.
n. c.	n. c.	14	n. c.
n. c.	n. c.	15	n. c.
n. c.	n. c.	16	n. c.
n. c.	n. c.	17	n. c.

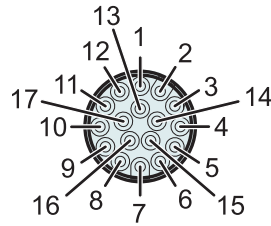

Connector Encoder J

View: Motor connector, plug side

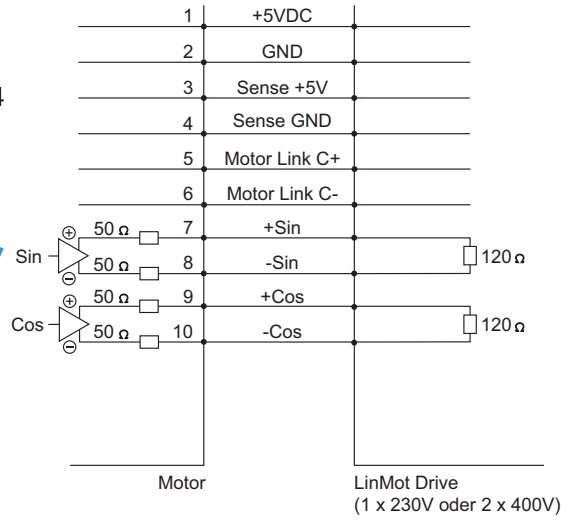

* The supply voltage at 5V sense supply is approx. 6V. Newer motors are provided with a modified power supply, that does not require sense lines any more. In that case, a supply voltage of 6...9V is permitted.

Motor Connector Wiring	Connector Power Q	Wire Color Cable KPS15-04
Phase U	1	red
PE	2	yellow-green
Phase W	3	black (previously: green)
Phase V	4	blue
n. c.	A	n. c.
n. c.	B	n. c.
n. c.	C	n. c.
n. c.	D	n. c.

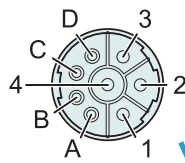

Connector Power Q

View: Motor connector, plug side

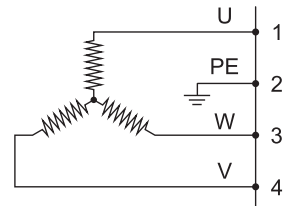

SIN/COS-POSITIONS-FEEDBACK (D0X-INTERFACE FOR 3RD PARTY DRIVES)

The linear motors of the P10-70 series have a contactless, integrated position feedback, which means that an external encoder is not required. The integrated position sensor technology of the motors with D0x interface provides a differential standard 1Vpp sin/cos signal with a 40mm period. The phase position of the sensor signals and the phase currents (with constant force in positive direction) is shown on the right side of the diagram. (The SIN encoder signal is in phase with the current characteristic of phase U).

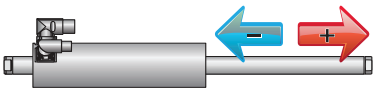

The arrows show the direction of movement of the slider. The stator remains in its position.

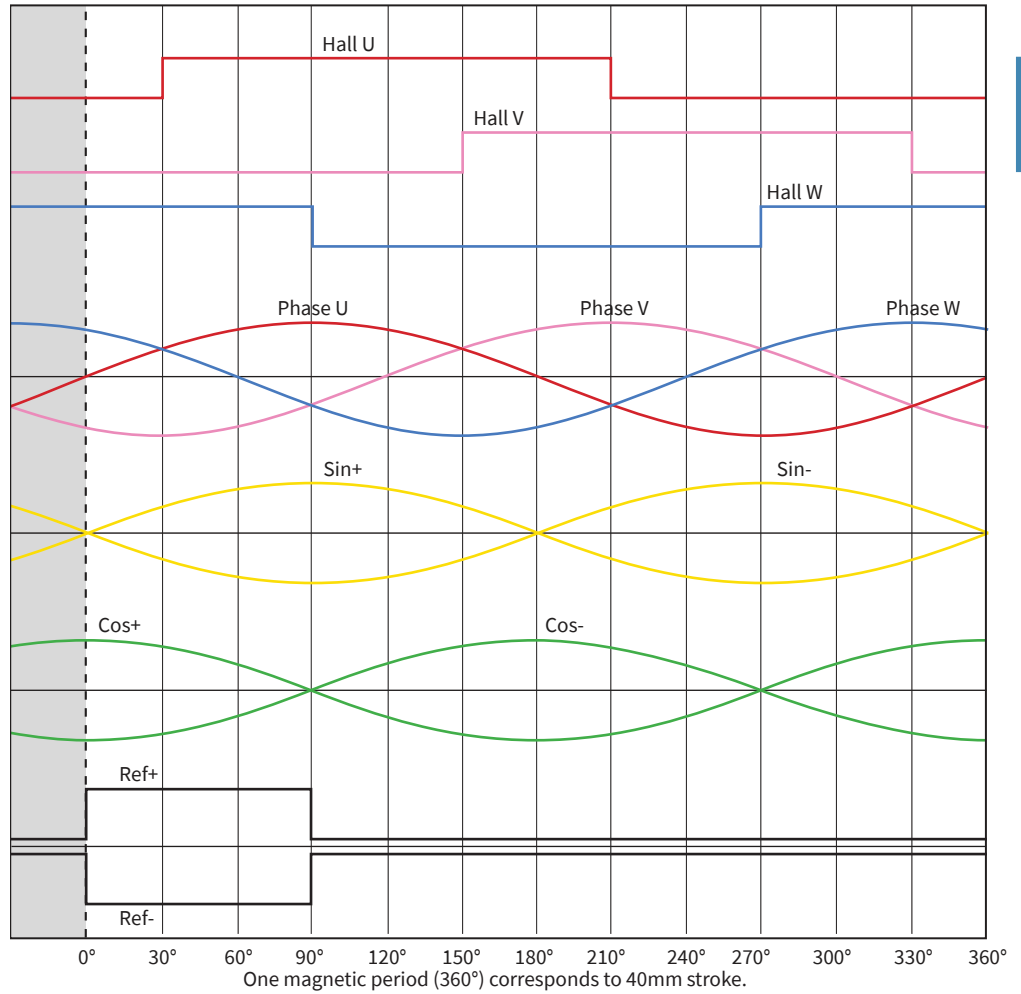

Sin / Cos		P10-70x...-D0x
Output signal period	mm	40
Signal amplitude ¹	V _{pp}	1
Termination ¹	Ohm	120
Supply voltage	Vdc	3...13 (w or w/o sense)
Power consumption	mW	< 1000
		(I < 150mA @ 5VDC, I < 80mA @ 12 VDC) ²

1) Applicable for Sin+/Sin-, Cos+/Cos- and Ref+/Ref- signals. Hall U/V/W are open collector signals.
 2) Power efficiency of the motor electronics varies with supply voltage

CONNECTOR PS10-70X240U-BL-QJ-D04/05 (SIN/COS-INTERFACE FOR 3RD PARTY DRIVES)

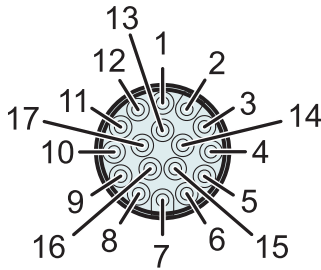

3 ... 13VDC
 (I_{max} < 150mA @ 5VDC)
 (I_{max} < 80mA @ 12VDC)

Connector Encoder J

View: Motor connector, plug side

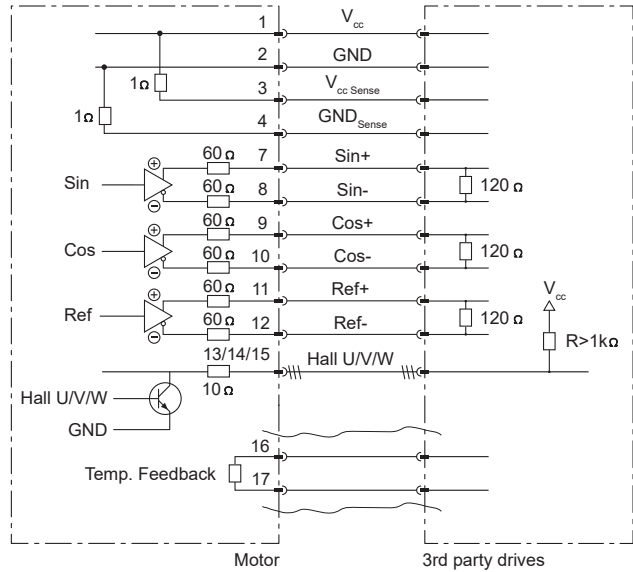

PS10-70X240U-BL-QJ-D04

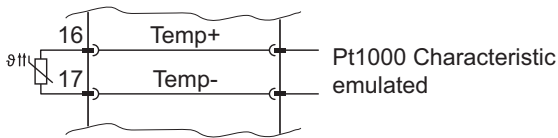

PS10-70X240U-BL-QJ-D05

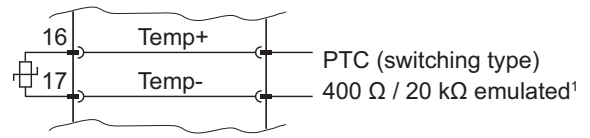

1) ≤ 400 Ω = no error, ≥ 20 kΩ = error

Sin/Cos-Interface: Encoder Connector Wiring				
PS10-70x240U-BL-QJ-D04	PS10-70x240U-BL-QJ-D05	Function	Connector Encoder J	Wire Color Motor Cable KSS05-02/13
3 ... 13VDC		Supply	1	white
GND		Supply	2	brown
Vcc Sense (optional)		Supply Sense	3	green
GND Sense (optional)		Supply Sense	4	yellow
Do not connect		-	5	-
Do not connect		-	6	-
Sin+		Encoder 1 Vpp	7	grey
Sin-		Encoder 1 Vpp	8	pink
Cos+		Encoder 1 Vpp	9	blue
Cos-		Encoder 1 Vpp	10	red
Ref+		Encoder 1 Vpp	11	black
Ref-		Encoder 1 Vpp	12	violett
Hall U		Encoder (open collector)	13	grey-red
Hall V		Encoder (open collector)	14	red-blue
Hall W		Encoder (open collector)	15	white-green
Temp+ (Pt1000 Char.)	Temp+ (PTC 400/20k Char.)	Temperature ²	16	yellow-brown
Temp- (Pt1000 Char.)	Temp- (PTC 400/20k Char.)	Temperature ²	17	white-yellow

2) The temperature evaluation circuit must have the same galvanic reference potential as the encoder circuit (supply). It should therefore be connected to the supply GND. For correct evaluation, the connection potentials of the emulated temperature sensor must be in the range of the supply potentials. Valid temperature values can only be measured 50ms after the encoder supply is applied. In the currentless state, a resistance of 200kOhm is measured between pin 16 and 17 is measured. The maximum voltage between pin 16 and 17 must not exceed 16VDC. The maximum current is 15mA.

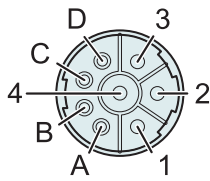

Connector Power Q
View: Motor connector, plug side

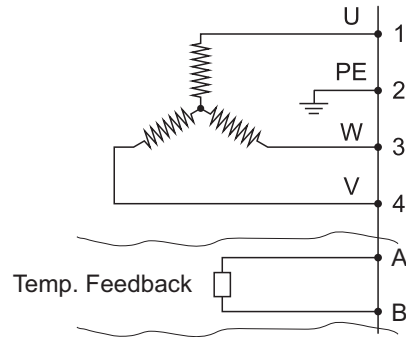

PS10-70X240U-BL-QJ-D04

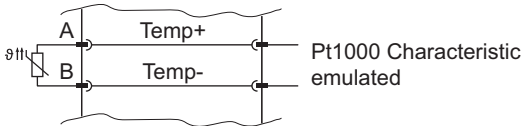

PS10-70X240U-BL-QJ-D05

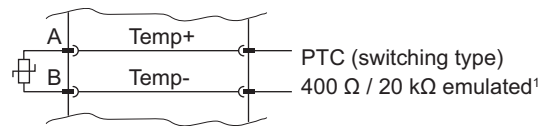

1) $\leq 400 \Omega$ = no error, $\geq 20 \text{ k}\Omega$ = error

Sin/Cos-Interface: Power Connector Wiring				
PS10-70x240U-BL-QJ-D04	PS10-70x240U-BL-QJ-D05	Connector Power Q	Wire Color Motor Cable KPS15-04	Wire Color Motor Cable KPS15-04/04
Phase U		1	red	red
PE		2	yellow-green	yellow-green
Phase W		3	black	black
Phase V		4	blue	blue
Pt1000+ ¹⁾	PTC+ ¹⁾	A	n. c.	purple
Pt1000- ¹⁾	PTC- ¹⁾	B	n. c.	grey
n. c.	n. c.	C	n. c.	yellow
n. c.	n. c.	D	n. c.	brown

1) The temperature evaluation circuit must have the same galvanic reference potential as the encoder circuit (supply). It should therefore be connected to the supply GND. For correct evaluation, the connection potentials of the emulated temperature sensor must be in the range of the supply potentials. Valid temperature values can only be measured 50ms after the encoder supply is applied. In currentless state a resistance of 200kOhm is measured between pin A and B. The maximum voltage between pin A and B must not exceed 16VDC. The maximum current is 15mA.

TEMPERATURE FEEDBACK DX4 / DX5

Overheating protection is provided by three internal thermistors embedded in the motor windings. These thermistors are monitored by the motor electronics. A single thermistor is tracked based on the maximum of the temperature readings. This is done to accurately monitor the temperature along the entire length of the stator and to react as quickly as possible to dynamic changes in a single motor phase. When the motor winding temperature reaches its absolute maximum value, the drive amplifier/servo controller must shut down the motor to protect the motor from overheating dam-

age. To support the temperature evaluation given by the drive amplifier/servocontroller, the various temperature interfaces -Dx4 or -Dx5 are available. Depending on the interface used and the signals used, there are suitable motor cables (see overview table, section Accessories/Motor cables).

Dx4 (Pt1000 dual)

An emulated **Pt1000 thermistor** is available on both the **signal and the power connector** for evaluating the max. motor temperature.

Dx5 (PTC dual)

An emulated **PTC thermistor** is available on both **the signal and the power connector**, which changes to the high-impedance state when the max. motor temperature is exceeded.

A/B INCREMENTAL POSITION FEEDBACK (D2X- INTERFACE FOR 3RD PARTY DRIVES)

The linear motors of the P10-70 series have a contactless, integrated position feedback, which means that an external encoder is not required.

The position output of the motors with D2x interface is an industry-standard A/B incremental signal with supplementary reference signal (RS422). Hall switch signals are available for commutation. The relationship between the phase current and the position sensor output is shown on the right.

4

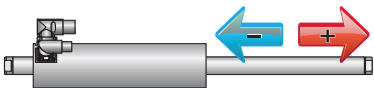

The arrows show the direction of movement of the slider. The stator remains in its position.

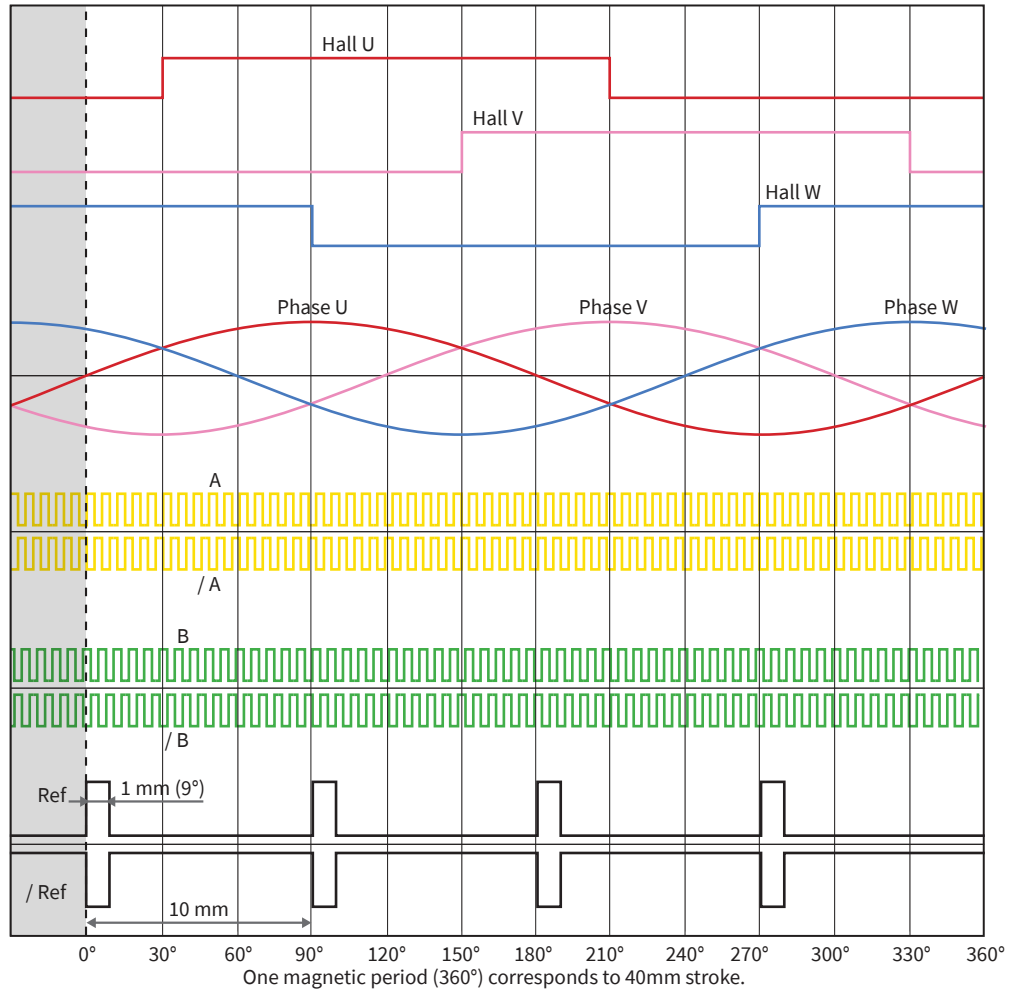

Example:

Min. pulse interval $t = 500 \text{ ns}$

For downstream evaluation, at least the following counter frequency is required:

$$f_{\text{counter}} = 1 / \text{pulse interval} = 1 / 500 \text{ ns} = 2 \text{ MHz}$$



The logical state of signals A and B is not defined in relation to the reference signal Ref. The signal shape may differ from the illustration.

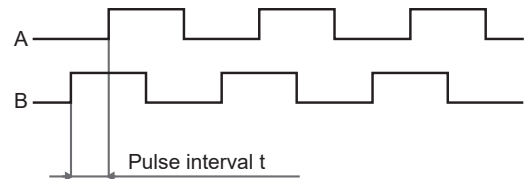

A / B		P10-70x...-D2x	P10-70x...-D2xS
Position Resolution	μm	1	5
Output Type		RS422	
Min. Edge Distance t	ns	100	500
Min. required counter frequency	MHz	10	2
Supply Voltage	Vdc	5-12	
Max. Supply Current	mA	300	300

CONNECTOR PS10-70X240U-BL-QJ-D24 / 24S / 25 / 25S / 26 (A/B-INTERFACE FOR 3RD PARTY DRIVES)

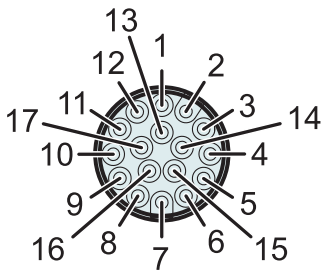

3 ... 13VDC
 (Imax < 150mA @ 5VDC)
 (Imax < 80mA @ 12VDC)

Connector Encoder J

View: Motor connector, plug side

**PS10-70X240U-BL-QJ-D24
 PS10-70X240U-BL-QJ-D24S**

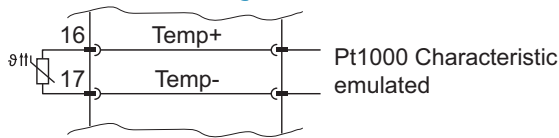

**PS10-70X240U-BL-QJ-D25
 PS10-70X240U-BL-QJ-D25S**

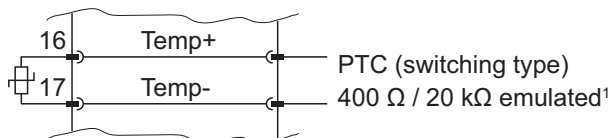

1) ≤ 400 Ω = no error, ≥ 20 kΩ = error

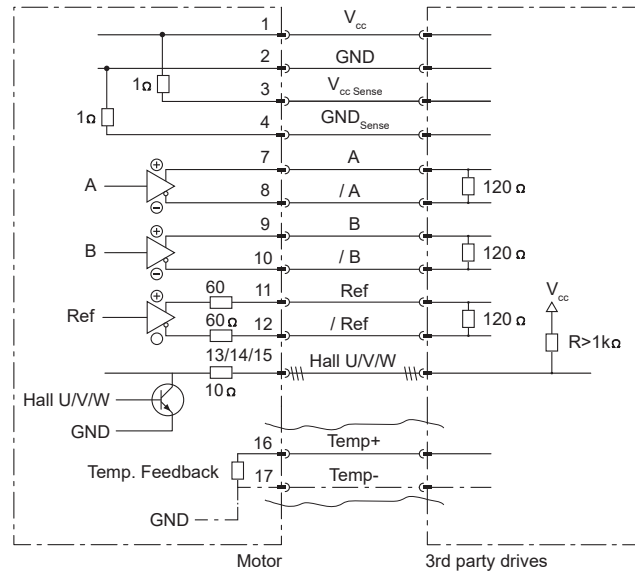

PS10-70X240U-BL-QJ-D26

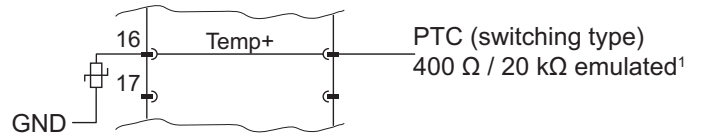

1) ≤ 400 Ω = no error, ≥ 20 kΩ = error

A/B-Interface: Encoder Connector Wiring

PS10-70x240U-BL-QJ-D24 PS10-70x240U-BL-QJ-D24S	PS10-70x240U-BL-QJ-D25 PS10-70x240U-BL-QJ-D25S	PS10-70x240U-BL-QJ-D26	Function	Connector Encoder J	Wire Color Motor Cable KSS05-02/13
3 ... 13VDC			Supply	1	white
GND			Supply	2	brown
Vcc Sense (optional)			Supply Sense	3	green
GND Sense (optional)			Supply Sense	4	yellow
Do not connect			-	5	-
Do not connect			-	6	-
A			Encoder	7	grey
/A			Encoder	8	pink
B			Encoder	9	blue
/B			Encoder	10	red
Ref			Encoder	11	black
/Ref			Encoder	12	violett
Hall U			Encoder (open collector)	13	grey-red
Hall V			Encoder (open collector)	14	red-blue
Hall W			Encoder (open collector)	15	white-green
Temp+ (Pt1000 Char.)	Temp+ (PTC 400/20k Char.)	Temp+ (PTC 400/20k Char.)	Temperature ²	16	yellow-brown
Temp- (Pt1000 Char.)	Temp- (PTC 400/20k Char.)	Do not connect	Temperature ²	17	white-yellow

2) The temperature evaluation circuit must have the same galvanic reference potential as the encoder circuit (supply). It should therefore be connected to the supply GND. For correct evaluation, the connection potentials of the emulated temperature sensor must be in the range of the supply potentials. Valid temperature values can only be measured 50ms after the encoder supply is applied. In the currentless state, a resistance of 200kOhm is measured between pin 16 and 17 is measured. The maximum voltage between pin 16 and 17 must not exceed 16VDC. The maximum current is 15mA.

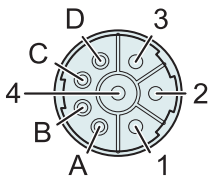

Connector Power Q

View: Motor connector, plug side

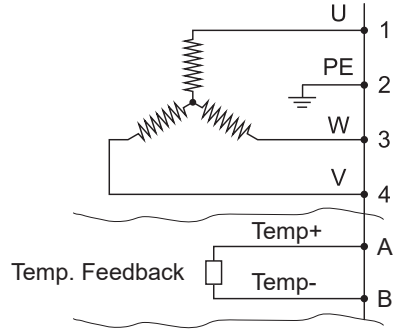

PS10-70X240U-BL-QJ-D24
PS10-70X240U-BL-QJ-D24S

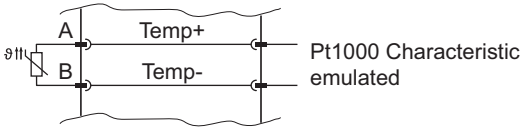

PS10-70X240U-BL-QJ-D25
PS10-70X240U-BL-QJ-D25S

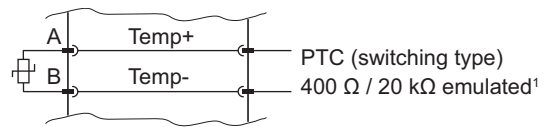

1) unter 400 Ω = no error, über 20 kΩ = error

A/B-Interface: Power Connector Wiring

PS10-70x240U-BL-QJ-D24 PS10-70x240U-BL-QJ-D24S	PS10-70x240U-BL-QJ-D25 PS10-70x240U-BL-QJ-D25S	PS10-70x240U-BL-QJ-D26	Connector Power Q	Wire Color Motor Cable KPS15-04	Wire Color Motor Cable KPS15-04/04
Phase U			1	red	red
PE			2	yellow-green	yellow-green
Phase W			3	black	black
Phase V			4	blue	blue
Pt1000+ ¹⁾	PTC+ ¹⁾	Do not connect	A	n.c.	purple
Pt1000- ¹⁾	PTC- ¹⁾	Do not connect	B	n.c.	grey
n.c.	n.c.	n.c.	C	n.c.	yellow
n.c.	n.c.	n.c.	D	n.c.	brown

1) The temperature evaluation circuit must have the same galvanic reference potential as the encoder circuit (supply). It should therefore be connected to the supply GND. For correct evaluation, the connection potentials of the emulated temperature sensor must be in the range of the supply potentials. Valid temperature values can only be measured 50ms after the encoder supply is applied. In currentless state a resistance of 200kOhm is measured between pin A and B. The maximum voltage between pin A and B must not exceed 16VDC. The maximum current is 15mA.

TEMPERATURE FEEDBACK DX4 / DX5 / DX6

Overheating protection is provided by three internal thermistors embedded in the motor windings. These thermistors are monitored by the motor electronics. A single thermistor is replicated based on the maximum of the temperature readings. This is done to accurately monitor the temperature along the entire length of the stator and to react as quickly as possible to dynamic changes in a single motor phase. When the motor winding temperature reaches its absolute maximum value, the drive amplifier/servo controller must shut down the motor to protect the motor from overheating damage. To support the temperature evaluation given by the drive amplifier/servo controller, different temperature interfaces -DX4, -DX5

or -DX6 are available. Depending on the interface used and the signals used, there are suitable motor cables (see overview table section Accessories/Motor cables).

Dx4 (Pt1000 dual)

An emulated **Pt1000 thermistor** is available on both the **signal and the power connector** for evaluating the max. motor temperature.

Dx5 (PTC dual)

An emulated **PTC thermistor** is available on both the **signal and the power connector**, which changes to the high-impedance state when the max. motor temperature is exceeded.

Dx6 (PTC)

An emulated PTC thermistor is available on the **signal connector**, which changes to the high-impedance state when the max. motor temperature is exceeded. The emulated **PTC** is internally **connected to GND on one side**, which is why only one additional signal line is connected to the servocontroller in addition to the power supply for evaluation.

BISS-C POSITION FEEDBACK (D3X- INTERFACE FOR 3RD PARTY DRIVES)

The linear motors of the P10-70 series have contactless, integrated position feedback, which means that there is no need for an external encoder.

The position feedback of the motors with D3x interface is based on RS422 and the industry-standard BiSS-C protocol. Either the transmitted position or the hall switch signals can be used for commutation. The relationship between the phase current and the encoder signals is shown on the right.

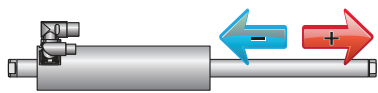

The arrows show the direction of movement of the slider. The stator remains in its position.

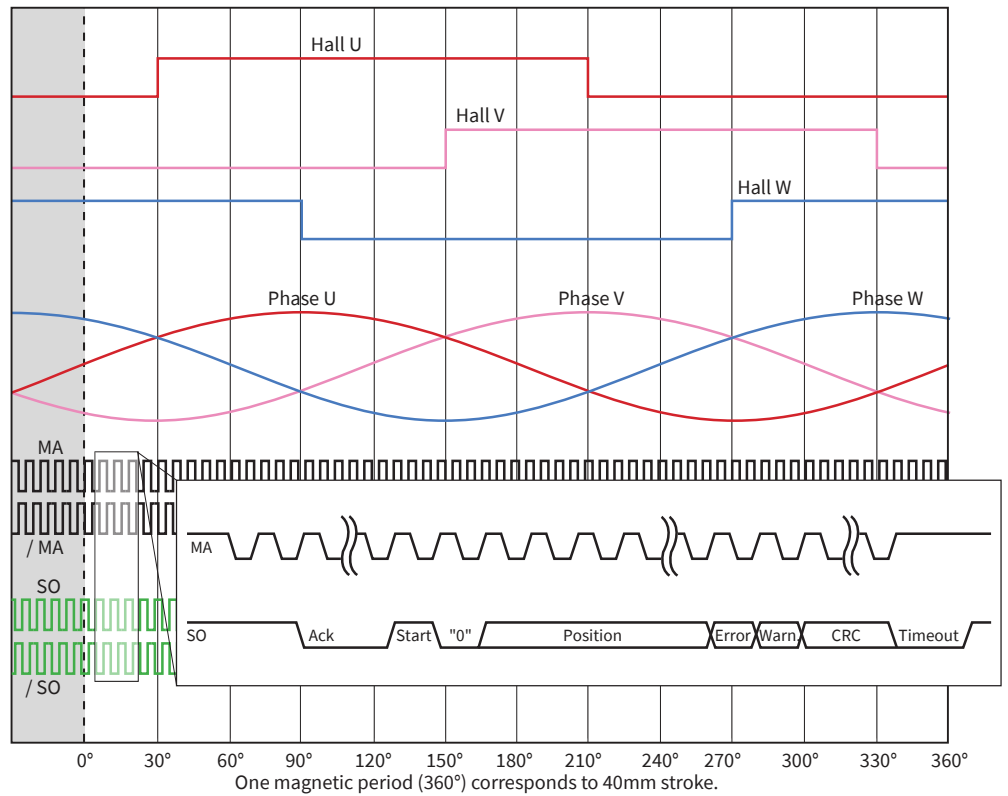

BiSS-C ¹	P10-70x...-D3x			
Singleturn Position Resolution	µm	~0.1526 (40 000 / 2 ¹⁸)		
Output Type		RS422		
Max. Frequency	MHz	3.3		
Min. Edge Distance t	ns	100		
Supply Voltage	Vdc	5 -12		
Max. Supply Current	mA	300		
Data Type		SCDS (Single Cycle Data Sensor)		
Data (Bits)		Position	nER	nWA
		Multiturn	Singleturn	
		16	18	1
Data Format and Alignment		Binary coded, MSB first, right aligned		
CRC polynomial		0x43 (X ⁶ + X ¹ + X ⁰) – CRC bit length 6 bits, CRC is inverted		
CRC Starting Value		0x00		
BiSS Timeout (tm)	µs	~20		
Switch-on Delay	ms	100		

1) Compatible with bidirectional interfaces supporting EDS register access and unidirectional interfaces

Commutation Angle

$$\text{Comm. Angle} = \frac{\text{Modulo (Pos. 40 mm)}}{\text{Magnetic Period}} \cdot 360^\circ$$

$$\text{Comm. Angle} = \frac{\text{Singleturn-Value}}{2^{18}} \cdot 360^\circ$$

BISS-C-FRAME DESCRIPTION

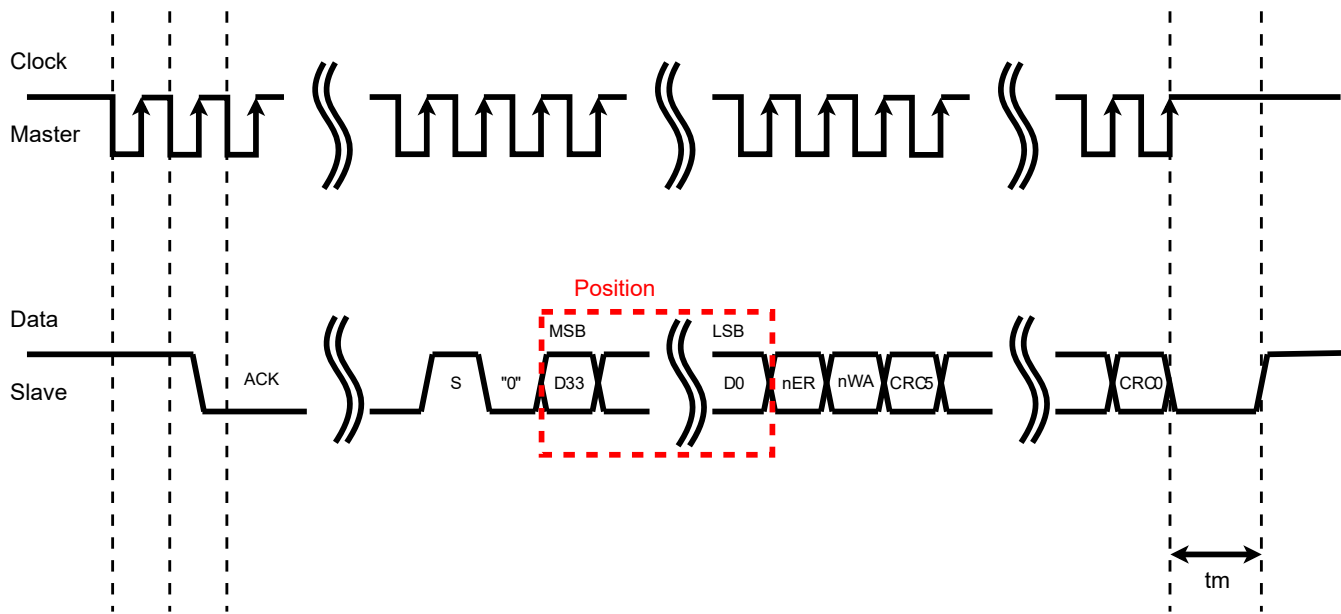

Multiturn Position 16 Bit: D33-D18

Binary coded, MSB first
 Resolution per bit = width of a pole pair
 P10-70: 40mm
 P10-54: 60mm
 After switching on the encoder, the multiturn position starts with an offset of 2.04m. The multiturn position is thus initialised to the following values:
 P10-54: 34
 P10-70: 51

Position $2^{16} = 90^\circ$
 Position $2^{17} = 180^\circ$
 Position $2^{18} = 360^\circ$
 The position or commutation angle is calculated as follows:
 Commutation angle = single turn position / $2^{18} * 360^\circ$

ted from the CRC calculation.

Singleturn Position 18 Bit: D17-D0

Binary coded, MSB first
 Resolution per bit = width of a pole pair / 2^{18}
 P10-70: $40'000 \mu\text{m} / 262'144 = 0.152587890625 \mu\text{m}$
 P10-54: $60'000 \mu\text{m} / 262'144 = 0.2288818359375 \mu\text{m}$
 The singleturn position maps the current position angle of the slider within a pole pair (magnetic period) of the motor. The singleturn position can therefore be used for commutation of the phase currents.
 Position 0 = 0°

Errorbit: nER
 0: error; 1: no error (active low).
 Indicates an encoder error. If this bit indicates an error, the position must be treated as invalid.

Warnbit: nWA
 0: warning; 1: no warning (active low).
 Displays encoder warnings. The position is still valid if only a warning is displayed.

CRC 6 Bit: CRC5-0
 Polynomial : 0x43
 Initial value : 0x00
 The CRC is calculated via position, error and warning bits.
 It is transmitted with MSB first and inverted. The start bit and the "0" bit are omitted from the CRC calculation.

Register and Memory Definitions

A description of how a BiSS-C master can access registers can be found at www.biss-interface.com.

BiSS-C - XML

The encoder is compatible with the "Standard Encoder Profile (BP3)".
 The function of the XML file is to automatically assign device properties in the master using the BiSS identifier.
 The XML file can be used by masters to facilitate the configuration of slave devices. It can be downloaded from www.linmot.com.

CONNECTOR PS10-70X240U-BL-QJ-D34 (BISS-C INTERFACE FOR 3RD PARTY DRIVES)

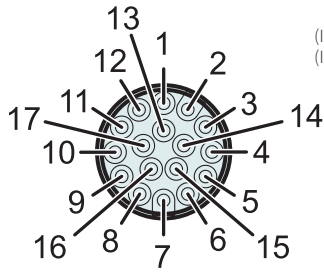

3 ... 13VDC
 (Imax < 150mA @ 5VDC)
 (Imax < 80mA @ 12VDC)

Connector Encoder J

View: Motor connector, plug side

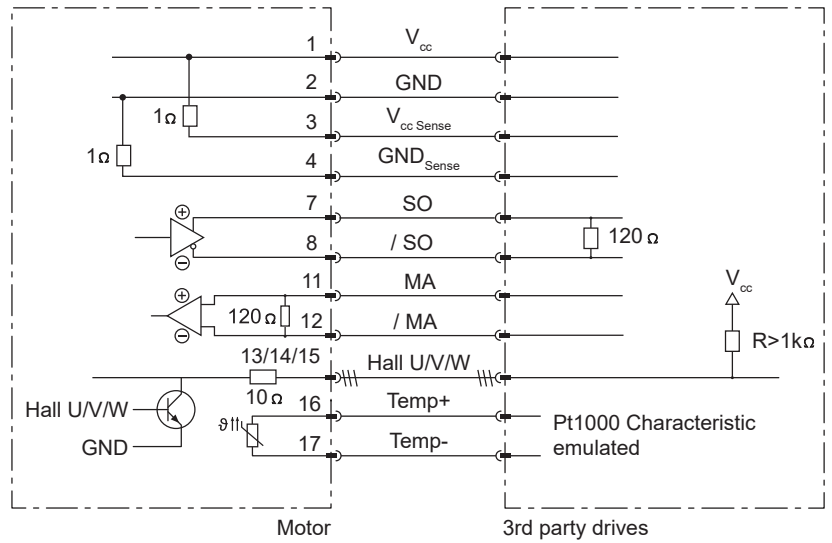

BiSS-C-Interface: Encoder Connector Wiring			
PS10-70x240U-BL-QJ-D34	Function	Connector Encoder J	Wire Color Motor Cable KSS05-02/13
3 ... 13VDC	Supply	1	white
GND	Supply	2	brown
Vcc Sense (optional)	Supply Sense	3	green
GND Sense (optional)	Supply Sense	4	yellow
Do not connect	-	5	-
Do not connect	-	6	-
SO (Slave out)	Encoder RS422	7	grey
/ SO (Slave out)	Encoder RS422	8	pink
Do not connect	-	9	-
Do not connect	-	10	-
MA (Master clock)	Encoder RS422	11	black
/ MA (Master clock)	Encoder RS422	12	violett
Hall U	Encoder (open collector)	13	grey-red
Hall V	Encoder (open collector)	14	red-blue
Hall W	Encoder (open collector)	15	white-green
Temp+ (Pt1000 Char.)	Temperature ¹	16	yellow-brown
Temp- (Pt1000 Char.)	Temperature ¹	17	white-yellow

1) The temperature evaluation circuit must have the same galvanic reference potential as the encoder circuit (supply). It should therefore be connected to the supply GND. For correct evaluation, the connection potentials of the emulated temperature sensor must be in the range of the supply potentials. Valid temperature values can only be measured 50ms after the encoder supply is applied. In the currentless state, a resistance of 200kOhm is measured between pin 16 and 17 is measured. The maximum voltage between pin 16 and 17 must not exceed 16VDC. The maximum current is 15mA.

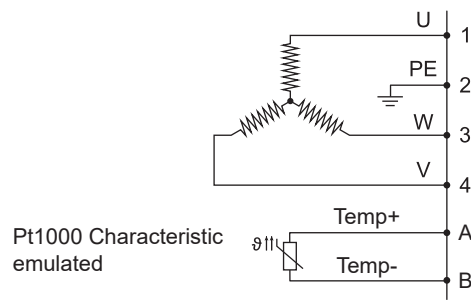
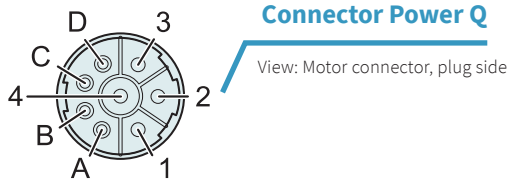

Pt1000 Characteristic emulated

BiSS-C-Interface: Power Connector Wiring			
PS10-70x240U-BL-QJ-D34	Connector Power Q	Wire Color Motor Cable KPS15-04	Wire Color Motor Cable KPS15-04/04
Phase U	1	red	red
PE	2	yellow-green	yellow-green
Phase W	3	black	black
Phase V	4	blue	blue
Pt1000+ ¹⁾	A	n. c.	purple
Pt1000- ¹⁾	B	n. c.	grey
n. c.	C	n. c.	yellow
n. c.	D	n. c.	brown

1) The temperature evaluation circuit must have the same galvanic reference potential as the encoder circuit (supply). It should therefore be connected to the supply GND. For correct evaluation, the connection potentials of the emulated temperature sensor must be in the range of the supply potentials. Valid temperature values can only be measured 50ms after the encoder supply is applied. In currentless state a resistance of 200kOhm is measured between pin A and B. The maximum voltage between pin A and B must not exceed 16VDC. The maximum current is 15mA.

TEMPERATURE FEEDBACK DX4

Overheating protection is provided by three internal thermistors embedded in the motor windings. These thermistors are monitored by the motor electronics. A single thermistor is tracked based on the maximum of the temperature readings. This is done to accurately monitor the temperature along the entire length of the stator and to react as quickly as possible to dynamic changes in a single motor phase. When the motor winding temperature reaches its ab-

solute maximum value, the drive amplifier/servo controller must shut down the motor to protect the motor from overheating damage. To support the temperature evaluation given by the drive amplifier/servocontroller, different temperature interfaces -DX4, -DX5 or -DX6 are available. Depending on the interface used and the signals used, there are suitable motor cables (see overview table, section Accessories/Motor cables).

Dx4 (Pt1000 dual)

An emulated **Pt1000 thermistor** is available on both the **signal and the power connector** for evaluating the max. motor temperature.

SLIDER

Slider Standard

The groove marks the front slider end.

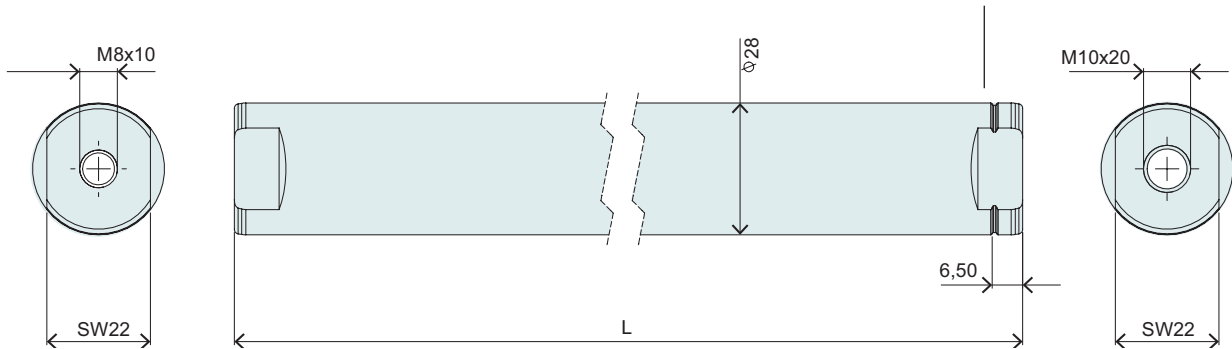

Slider Standard			
Item	Description	Max. Stroke [mm]	Item-No.
PL10-28x390/340	Slider for P10-70 'standard'	90	0150-2194
PL10-28x490/440	Slider for P10-70 'standard'	190	0150-2195
PL10-28x590/540	Slider for P10-70 'standard'	290	0150-2196
PL10-28x690/640	Slider for P10-70 'standard'	390	0150-2197
PL10-28x790/740	Slider for P10-70 'standard'	490	0150-2198
PL10-28x890/840	Slider for P10-70 'standard'	590	0150-2199
PL10-28x990/940	Slider for P10-70 'standard'	690	0150-2203
PL10-28x1190/1140	Slider for P10-70 'standard'	890	0150-2204
PL10-28x1390/1340	Slider for P10-70 'standard'	1090	0150-2205
PL10-28x1590/1540	Slider for P10-70 'standard'	1290	0150-2206
PL10-28x1790/1740	Slider for P10-70 'standard'	1490	0150-2207
PL10-28x1990/1940	Läufer für P10-70 'standard'	1690	0150-2208

P10-70x240U/10-BL-QJ

Max. Stroke: 10 mm
Peak Force: 1650 N

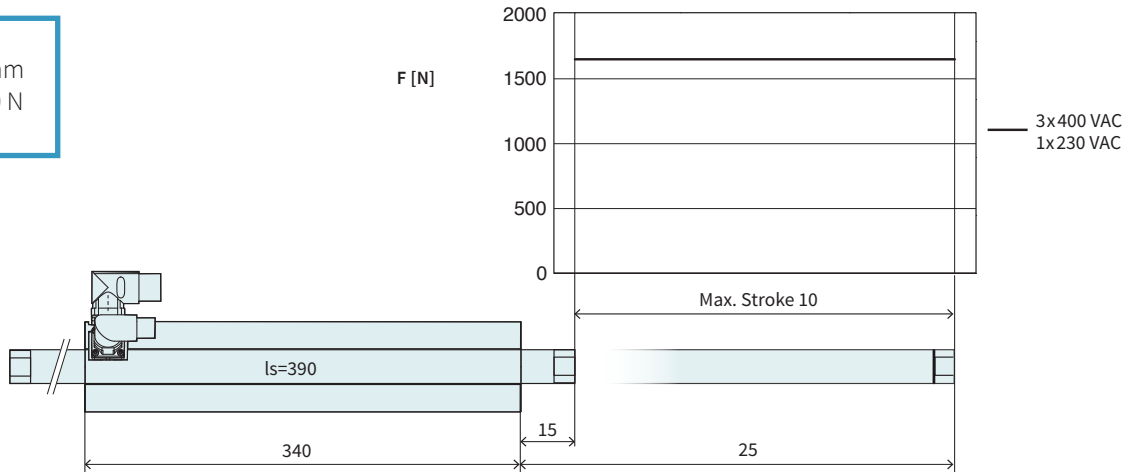

Dimensions in mm

Technical Data P10-70x240U/10

Stroke			
Max. Stroke	mm (in)		10 (0.39)
Force			
Max. Force ¹ @ 1x230VAC	N (lbf)		1650 (371)
Max. Force ¹ @ 3x400VAC	N (lbf)		1650 (371)
Max. Cont. Force [Passive cooling / Fan / Fluid]	N (lbf)		190 / 290 / 510 (43 / 66 / 120)
Max. Border Force relative	%		100
Force Constant 1	N/A _{pk} (lbf/A _{pk})		59 (13.3)
Force Constant 2	N/A _{rms} (lbf/A _{rms})		83.4 (18.8)
Velocity			
Max. Velocity @ 1x230VAC	m/s (in/s)		3 (119.9)
Max. Velocity @ 3x400VAC	m/s (in/s)		5.4 (5.4)
Position Detection			
Repeatability	mm (in)		±0.05 (±0.002)
Linearity	%		± 5.1
Electrical Data			
Max. Current ¹ @ 1x230VAC	A _{pk} / A _{rms}		27.9 / 19.7
Max. Current ¹ @ 3x400VAC	A _{pk} / A _{rms}		27.9 / 19.7
Max. Cont. Current 1 [Passive cooling / Fan / Fluid]	A _{pk}		3.3 / 5 / 8.7
Max. Cont. Current 2 [Passive cooling / Fan / Fluid]	A _{rms}		2.3 / 3.5 / 6.1
Thermal Data			
Max. Winding Temperature (Sensor)	°C		90
Thermal Resistance [Passive cooling / Fan / Fluid]	°K/W		0.87 / 0.38 / 0.12
Thermal Time Constant [Passive cooling / Fan / Fluid]	s		2100 / 510 / 110
Mechanical Data			
Slider Length	mm (in)		390 (15)
Slider Mass	g (lb)		1830 (4.03)

1) Real time calculation of motor winding temperature is required (including monitoring).
 If temperature monitoring is only based on temperature sensor signal (missing thermal model calculation), 60 % of the peak value has to be taken instead.



Item	Description	Item-No.
PS10-70x240U-BL-QJ	Stator 3x400VAC, LinMot Encoder	0150-1293
PS10-70x240U-BL-QJ-D04	Stator 3x400VAC, Sin/Cos Encoder 1Vpp, Pt1000 dual	0150-4262
PS10-70x240U-BL-QJ-D05	Stator 3x400VAC, Sin/Cos Encoder 1Vpp, PTC dual	0150-4607
PS10-70x240U-BL-QJ-D24	Stator 3x400VAC, A/B Encoder 1µm, Pt1000 dual	0150-4132
PS10-70x240U-BL-QJ-D24S	Stator 3x400VAC, A/B Encoder 5µm, Pt1000 dual	0150-4597
PS10-70x240U-BL-QJ-D25	Stator 3x400VAC, A/B Encoder 1µm, PTC dual	0150-5762
PS10-70x240U-BL-QJ-D25S	Stator 3x400VAC, A/B Encoder 5µm, PTC dual	0150-4602
PS10-70x240U-BL-QJ-D26	Stator 3x400VAC, A/B Encoder 1µm, PTC single ended	0150-4516
PS10-70x240U-BL-QJ-D34	Stator 3x400VAC, BiSS-C, Pt1000 dual	0150-4872
PL10-28x390/340	Slider for P10-70 'standard'	0150-2194

P10-70x240U/110-BL-QJ

Max. Stroke: 110 mm
Peak Force: 1650 N

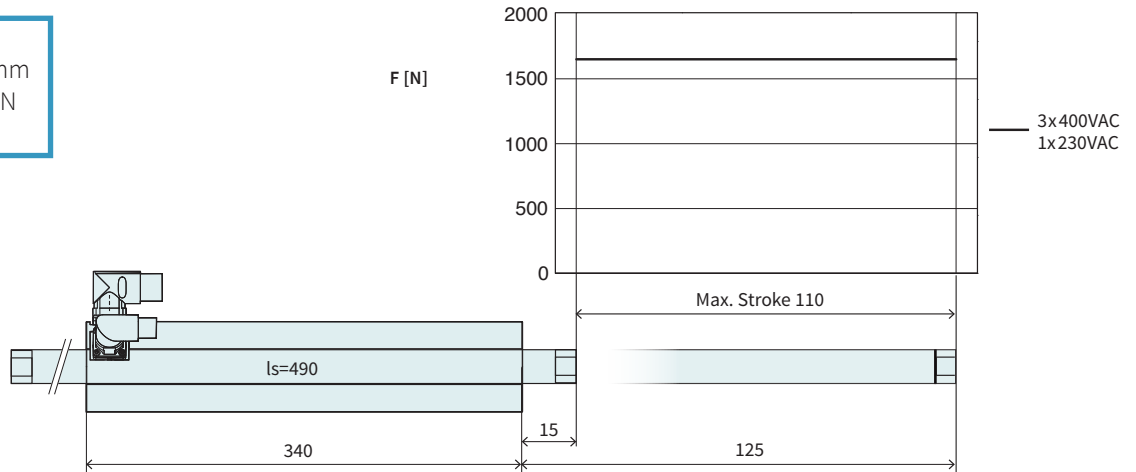

Dimensions in mm

Technical Data P10-70x240U/110			
Stroke			
Max. Stroke	mm (in)	110 (4.32)	
Force			
Max. Force ¹ @ 1x230VAC	N (lbf)	1650 (371)	
Max. Force ¹ @ 3x400VAC	N (lbf)	1650 (371)	
Max. Cont. Force [Passive cooling / Fan / Fluid]	N (lbf)	190 / 290 / 510 (43 / 66 / 120)	
Max. Border Force relative	%	100	
Force Constant 1	N/A _{pk} (lbf/A _{pk})	59 (13.3)	
Force Constant 2	N/A _{rms} (lbf/A _{rms})	83.4 (18.8)	
Velocity			
Max. Velocity @ 1x230VAC	m/s (in/s)	3 (119.9)	
Max. Velocity @ 3x400VAC	m/s (in/s)	5.4 (5.4)	
Position Detection			
Repeatability	mm (in)	±0.05 (±0.002)	
Linearity	%	±0.55	
Electrical Data			
Max. Current ¹ @ 1x230VAC	A _{pk} / A _{rms}	27.9 / 19.7	
Max. Current ¹ @ 3x400VAC	A _{pk} / A _{rms}	27.9 / 19.7	
Max. Cont. Current 1 [Passive cooling / Fan / Fluid]	A _{pk}	3.3 / 5 / 8.7	
Max. Cont. Current 2 [Passive cooling / Fan / Fluid]	A _{rms}	2.3 / 3.5 / 6.1	
Thermal Data			
Max. Winding Temperature (Sensor)	°C	90	
Thermal Resistance [Passive cooling / Fan / Fluid]	°K/W	0.87 / 0.38 / 0.12	
Thermal Time Constant [Passive cooling / Fan / Fluid]	s	2100 / 510 / 110	
Mechanical Data			
Slider Length	mm (in)	490 (19)	
Slider Mass	g (lb)	2300 (5.06)	

¹ Real time calculation of motor winding temperature is required (including monitoring).
 If temperature monitoring is only based on temperature sensor signal (missing thermal model calculation), 60 % of the peak value has to be taken instead.



Item	Description	Item-No.
PS10-70x240U-BL-QJ	Stator 3x400VAC, LinMot Encoder	0150-1293
PS10-70x240U-BL-QJ-D04	Stator 3x400VAC, Sin/Cos Encoder 1Vpp, Pt1000 dual	0150-4262
PS10-70x240U-BL-QJ-D05	Stator 3x400VAC, Sin/Cos Encoder 1Vpp, PTC dual	0150-4607
PS10-70x240U-BL-QJ-D24	Stator 3x400VAC, A/B Encoder 1µm, Pt1000 dual	0150-4132
PS10-70x240U-BL-QJ-D24S	Stator 3x400VAC, A/B Encoder 5µm, Pt1000 dual	0150-4597
PS10-70x240U-BL-QJ-D25	Stator 3x400VAC, A/B Encoder 1µm, PTC dual	0150-5762
PS10-70x240U-BL-QJ-D25S	Stator 3x400VAC, A/B Encoder 5µm, PTC dual	0150-4602
PS10-70x240U-BL-QJ-D26	Stator 3x400VAC, A/B Encoder 1µm, PTC single ended	0150-4516
PS10-70x240U-BL-QJ-D34	Stator 3x400VAC, BiSS-C, Pt1000 dual	0150-4872
PL10-28x490/440	Slider for P10-70 'standard'	0150-2195

P10-70x240U/210-BL-QJ

Max. Stroke: 210 mm
Peak Force: 1650 N

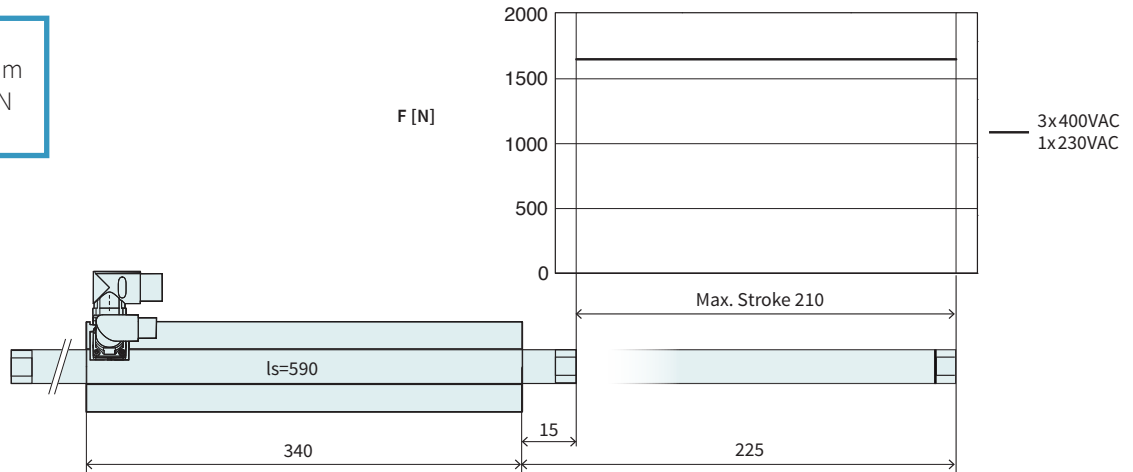

Dimensions in mm

Technical Data P10-70x240U/210			
Stroke			
Max. Stroke	mm (in)	210 (8.26)	
Force			
Max. Force ¹ @ 1x230VAC	N (lbf)	1650 (371)	
Max. Force ¹ @ 3x400VAC	N (lbf)	1650 (371)	
Max. Cont. Force [Passive cooling / Fan / Fluid]	N (lbf)	190 / 290 / 510 (43 / 66 / 120)	
Max. Border Force relative	%	100	
Force Constant 1	N/A _{pk} (lbf/A _{pk})	59 (13.3)	
Force Constant 2	N/A _{rms} (lbf/A _{rms})	83.4 (18.8)	
Velocity			
Max. Velocity @ 1x230VAC	m/s (in/s)	3 (119.9)	
Max. Velocity @ 3x400VAC	m/s (in/s)	5.4 (5.4)	
Position Detection			
Repeatability	mm (in)	±0.05 (±0.002)	
Linearity	%	± 0.35	
Electrical Data			
Max. Current ¹ @ 1x230VAC	A _{pk} / A _{rms}	27.9 / 19.7	
Max. Current ¹ @ 3x400VAC	A _{pk} / A _{rms}	27.9 / 19.7	
Max. Cont. Current 1 [Passive cooling / Fan / Fluid]	A _{pk}	3.3 / 5 / 8.7	
Max. Cont. Current 2 [Passive cooling / Fan / Fluid]	A _{rms}	2.3 / 3.5 / 6.1	
Thermal Data			
Max. Winding Temperature (Sensor)	°C	90	
Thermal Resistance [Passive cooling / Fan / Fluid]	°K/W	0.87 / 0.38 / 0.12	
Thermal Time Constant [Passive cooling / Fan / Fluid]	s	2100 / 510 / 110	
Mechanical Data			
Slider Length	mm (in)	590 (23)	
Slider Mass	g (lb)	2770 (6.09)	

1) Real time calculation of motor winding temperature is required (including monitoring).
 If temperature monitoring is only based on temperature sensor signal (missing thermal model calculation), 60 % of the peak value has to be taken instead.



Item	Description	Item-No.
PS10-70x240U-BL-QJ	Stator 3x400VAC, LinMot Encoder	0150-1293
PS10-70x240U-BL-QJ-D04	Stator 3x400VAC, Sin/Cos Encoder 1Vpp, Pt1000 dual	0150-4262
PS10-70x240U-BL-QJ-D05	Stator 3x400VAC, Sin/Cos Encoder 1Vpp, PTC dual	0150-4607
PS10-70x240U-BL-QJ-D24	Stator 3x400VAC, A/B Encoder 1µm, Pt1000 dual	0150-4132
PS10-70x240U-BL-QJ-D24S	Stator 3x400VAC, A/B Encoder 5µm, Pt1000 dual	0150-4597
PS10-70x240U-BL-QJ-D25	Stator 3x400VAC, A/B Encoder 1µm, PTC dual	0150-5762
PS10-70x240U-BL-QJ-D25S	Stator 3x400VAC, A/B Encoder 5µm, PTC dual	0150-4602
PS10-70x240U-BL-QJ-D26	Stator 3x400VAC, A/B Encoder 1µm, PTC single ended	0150-4516
PS10-70x240U-BL-QJ-D34	Stator 3x400VAC, BiSS-C, Pt1000 dual	0150-4872
PL10-28x590/540	Slider for P10-70 'standard'	0150-2196

P10-70x240U/310-BL-QJ

Max. Stroke: 310 mm
Peak Force: 1650 N

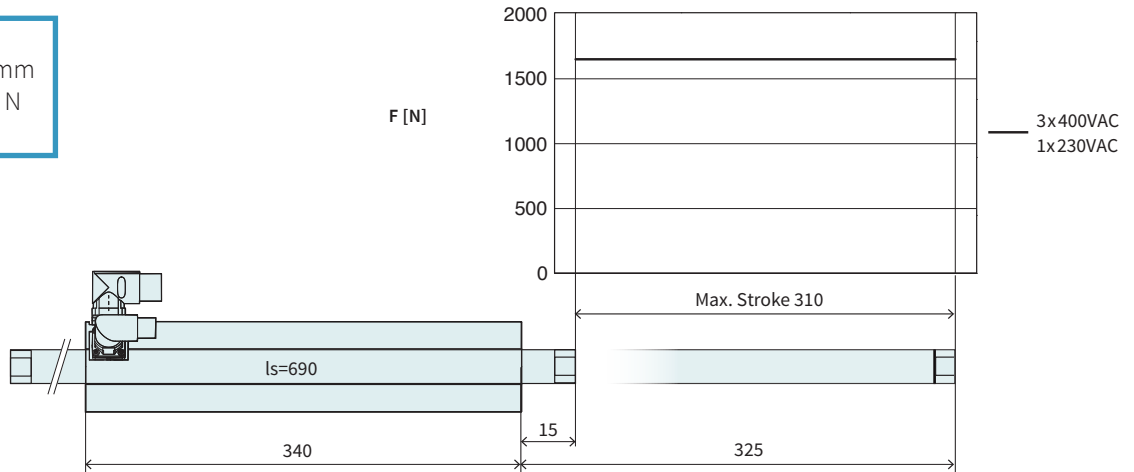

Dimensions in mm

Technical Data P10-70x240U/310			
Stroke			
Max. Stroke	mm (in)	310 (12.19)	
Force			
Max. Force ¹ @ 1x230VAC	N (lbf)	1650 (371)	
Max. Force ¹ @ 3x400VAC	N (lbf)	1650 (371)	
Max. Cont. Force [Passive cooling / Fan / Fluid]	N (lbf)	190 / 290 / 510 (43 / 66 / 120)	
Max. Border Force relative	%	100	
Force Constant 1	N/A _{pk} (lbf/A _{pk})	59 (13.3)	
Force Constant 2	N/A _{rms} (lbf/A _{rms})	83.4 (18.8)	
Velocity			
Max. Velocity @ 1x230VAC	m/s (in/s)	3 (119.9)	
Max. Velocity @ 3x400VAC	m/s (in/s)	5.4 (5.4)	
Position Detection			
Repeatability	mm (in)	±0.05 (±0.002)	
Linearity	%	±0.25	
Electrical Data			
Max. Current ¹ @ 1x230VAC	A _{pk} / A _{rms}	27.9 / 19.7	
Max. Current ¹ @ 3x400VAC	A _{pk} / A _{rms}	27.9 / 19.7	
Max. Cont. Current 1 [Passive cooling / Fan / Fluid]	A _{pk}	3.3 / 5 / 8.7	
Max. Cont. Current 2 [Passive cooling / Fan / Fluid]	A _{rms}	2.3 / 3.5 / 6.1	
Thermal Data			
Max. Winding Temperature (Sensor)	°C	90	
Thermal Resistance [Passive cooling / Fan / Fluid]	°K/W	0.87 / 0.38 / 0.12	
Thermal Time Constant [Passive cooling / Fan / Fluid]	s	2100 / 510 / 110	
Mechanical Data			
Slider Length	mm (in)	690 (27)	
Slider Mass	g (lb)	3240 (7.13)	

¹ Real time calculation of motor winding temperature is required (including monitoring).
 If temperature monitoring is only based on temperature sensor signal (missing thermal model calculation), 60 % of the peak value has to be taken instead.



Item	Description	Item-No.
PS10-70x240U-BL-QJ	Stator 3x400VAC, LinMot Encoder	0150-1293
PS10-70x240U-BL-QJ-D04	Stator 3x400VAC, Sin/Cos Encoder 1Vpp, Pt1000 dual	0150-4262
PS10-70x240U-BL-QJ-D05	Stator 3x400VAC, Sin/Cos Encoder 1Vpp, PTC dual	0150-4607
PS10-70x240U-BL-QJ-D24	Stator 3x400VAC, A/B Encoder 1µm, Pt1000 dual	0150-4132
PS10-70x240U-BL-QJ-D24S	Stator 3x400VAC, A/B Encoder 5µm, Pt1000 dual	0150-4597
PS10-70x240U-BL-QJ-D25	Stator 3x400VAC, A/B Encoder 1µm, PTC dual	0150-5762
PS10-70x240U-BL-QJ-D25S	Stator 3x400VAC, A/B Encoder 5µm, PTC dual	0150-4602
PS10-70x240U-BL-QJ-D26	Stator 3x400VAC, A/B Encoder 1µm, PTC single ended	0150-4516
PS10-70x240U-BL-QJ-D34	Stator 3x400VAC, BiSS-C, Pt1000 dual	0150-4872
PL10-28x690/640	Slider for P10-70 'standard'	0150-2197

P10-70x240U/410-BL-QJ

Max. Stroke: 410 mm
Peak Force: 1650 N

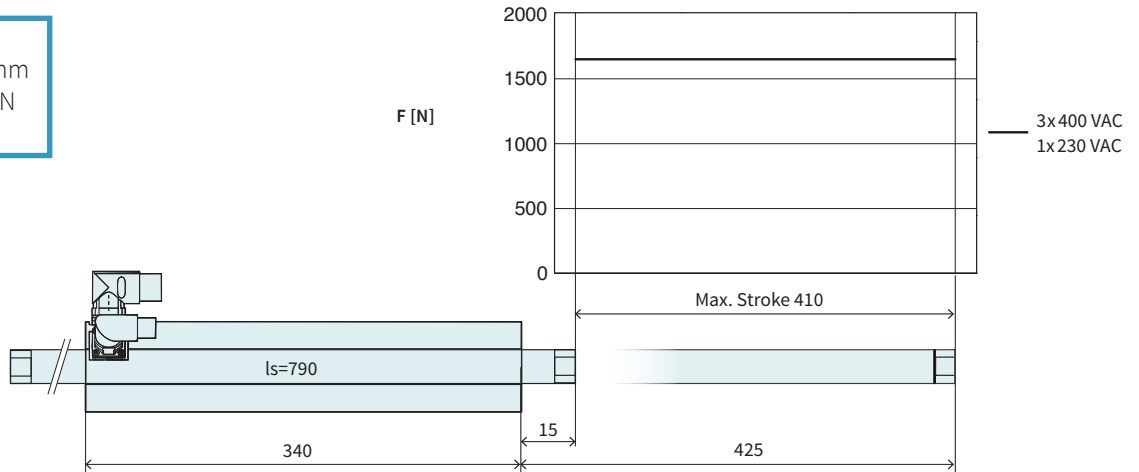

Dimensions in mm

Technical Data P10-70x240U/410			
Stroke			
Max. Stroke	mm (in)		410 (16.1)
Force			
Max. Force ¹ @ 1x230VAC	N (lbf)		1650 (371)
Max. Force ¹ @ 3x400VAC	N (lbf)		1650 (371)
Max. Cont. Force [Passive cooling / Fan / Fluid]	N (lbf)		190 / 290 / 510 (43 / 66 / 120)
Max. Border Force relative	%		100
Force Constant 1	N/A _{pk} (lbf/A _{pk})		59 (13.3)
Force Constant 2	N/A _{rms} (lbf/A _{rms})		83.4 (18.8)
Velocity			
Max. Velocity @ 1x230VAC	m/s (in/s)		3 (119.9)
Max. Velocity @ 3x400VAC	m/s (in/s)		5.4 (5.4)
Position Detection			
Repeatability	mm (in)		±0.05 (±0.002)
Linearity	%		± 0.2
Electrical Data			
Max. Current ¹ @ 1x230VAC	A _{pk} / A _{rms}		27.9 / 19.7
Max. Current ¹ @ 3x400VAC	A _{pk} / A _{rms}		27.9 / 19.7
Max. Cont. Current 1 [Passive cooling / Fan / Fluid]	A _{pk}		3.3 / 5 / 8.7
Max. Cont. Current 2 [Passive cooling / Fan / Fluid]	A _{rms}		2.3 / 3.5 / 6.1
Thermal Data			
Max. Winding Temperature (Sensor)	°C		90
Thermal Resistance [Passive cooling / Fan / Fluid]	°K/W		0.87 / 0.38 / 0.12
Thermal Time Constant [Passive cooling / Fan / Fluid]	s		2100 / 510 / 110
Mechanical Data			
Slider Length	mm (in)		790 (31)
Slider Mass	g (lb)		3710 (8.16)

1) Real time calculation of motor winding temperature is required (including monitoring).
 If temperature monitoring is only based on temperature sensor signal (missing thermal model calculation), 60 % of the peak value has to be taken instead.



Item	Description	Item-No.
PS10-70x240U-BL-QJ	Stator 3x400VAC, LinMot Encoder	0150-1293
PS10-70x240U-BL-QJ-D04	Stator 3x400VAC, Sin/Cos Encoder 1Vpp, Pt1000 dual	0150-4262
PS10-70x240U-BL-QJ-D05	Stator 3x400VAC, Sin/Cos Encoder 1Vpp, PTC dual	0150-4607
PS10-70x240U-BL-QJ-D24	Stator 3x400VAC, A/B Encoder 1µm, Pt1000 dual	0150-4132
PS10-70x240U-BL-QJ-D24S	Stator 3x400VAC, A/B Encoder 5µm, Pt1000 dual	0150-4597
PS10-70x240U-BL-QJ-D25	Stator 3x400VAC, A/B Encoder 1µm, PTC dual	0150-5762
PS10-70x240U-BL-QJ-D25S	Stator 3x400VAC, A/B Encoder 5µm, PTC dual	0150-4602
PS10-70x240U-BL-QJ-D26	Stator 3x400VAC, A/B Encoder 1µm, PTC single ended	0150-4516
PS10-70x240U-BL-QJ-D34	Stator 3x400VAC, BiSS-C, Pt1000 dual	0150-4872
PL10-28x790/740	Slider for P10-70 'standard'	0150-2198

P10-70x240U/510-BL-QJ

Max. Stroke: 510 mm
Peak Force: 1650 N

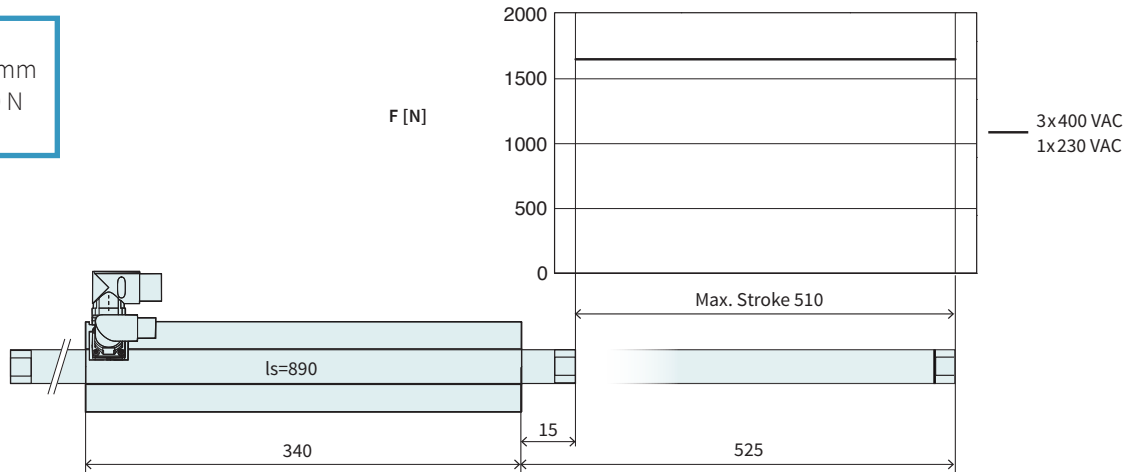

Dimensions in mm

Technical Data P10-70x240U/510			
Stroke			
Max. Stroke	mm (in)	510 (20.1)	
Force			
Max. Force ¹ @ 1x230VAC	N (lbf)	1650 (371)	
Max. Force ¹ @ 3x400VAC	N (lbf)	1650 (371)	
Max. Cont. Force [Passive cooling / Fan / Fluid]	N (lbf)	190 / 290 / 510 (43 / 66 / 120)	
Max. Border Force relative	%	100	
Force Constant 1	N/A _{pk} (lbf/A _{pk})	59 (13.3)	
Force Constant 2	N/A _{rms} (lbf/A _{rms})	83.4 (18.8)	
Velocity			
Max. Velocity @ 1x230VAC	m/s (in/s)	3 (119.9)	
Max. Velocity @ 3x400VAC	m/s (in/s)	5.4 (5.4)	
Position Detection			
Repeatability	mm (in)	±0.05 (±0.002)	
Linearity	%	± 0.2	
Electrical Data			
Max. Current ¹ @ 1x230VAC	A _{pk} / A _{rms}	27.9 / 19.7	
Max. Current ¹ @ 3x400VAC	A _{pk} / A _{rms}	27.9 / 19.7	
Max. Cont. Current 1 [Passive cooling / Fan / Fluid]	A _{pk}	3.3 / 5 / 8.7	
Max. Cont. Current 2 [Passive cooling / Fan / Fluid]	A _{rms}	2.3 / 3.5 / 6.1	
Thermal Data			
Max. Winding Temperature (Sensor)	°C	90	
Thermal Resistance [Passive cooling / Fan / Fluid]	°K/W	0.87 / 0.38 / 0.12	
Thermal Time Constant [Passive cooling / Fan / Fluid]	s	2100 / 510 / 110	
Mechanical Data			
Slider Length	mm (in)	890 (35)	
Slider Mass	g (lb)	4180 (9.2)	

¹ Real time calculation of motor winding temperature is required (including monitoring).
 If temperature monitoring is only based on temperature sensor signal (missing thermal model calculation), 60 % of the peak value has to be taken instead.

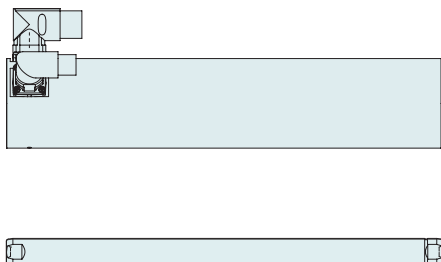

Item	Description	Item-No.
PS10-70x240U-BL-QJ	Stator 3x400VAC, LinMot Encoder	0150-1293
PS10-70x240U-BL-QJ-D04	Stator 3x400VAC, Sin/Cos Encoder 1Vpp, Pt1000 dual	0150-4262
PS10-70x240U-BL-QJ-D05	Stator 3x400VAC, Sin/Cos Encoder 1Vpp, PTC dual	0150-4607
PS10-70x240U-BL-QJ-D24	Stator 3x400VAC, A/B Encoder 1µm, Pt1000 dual	0150-4132
PS10-70x240U-BL-QJ-D24S	Stator 3x400VAC, A/B Encoder 5µm, Pt1000 dual	0150-4597
PS10-70x240U-BL-QJ-D25	Stator 3x400VAC, A/B Encoder 1µm, PTC dual	0150-5762
PS10-70x240U-BL-QJ-D25S	Stator 3x400VAC, A/B Encoder 5µm, PTC dual	0150-4602
PS10-70x240U-BL-QJ-D26	Stator 3x400VAC, A/B Encoder 1µm, PTC single ended	0150-4516
PS10-70x240U-BL-QJ-D34	Stator 3x400VAC, BiSS-C, Pt1000 dual	0150-4872
PL10-28x890/840	Slider for P10-70 'standard'	0150-2199

P10-70x240U/610-BL-QJ

Max. Stroke: 610 mm
Peak Force: 1650 N

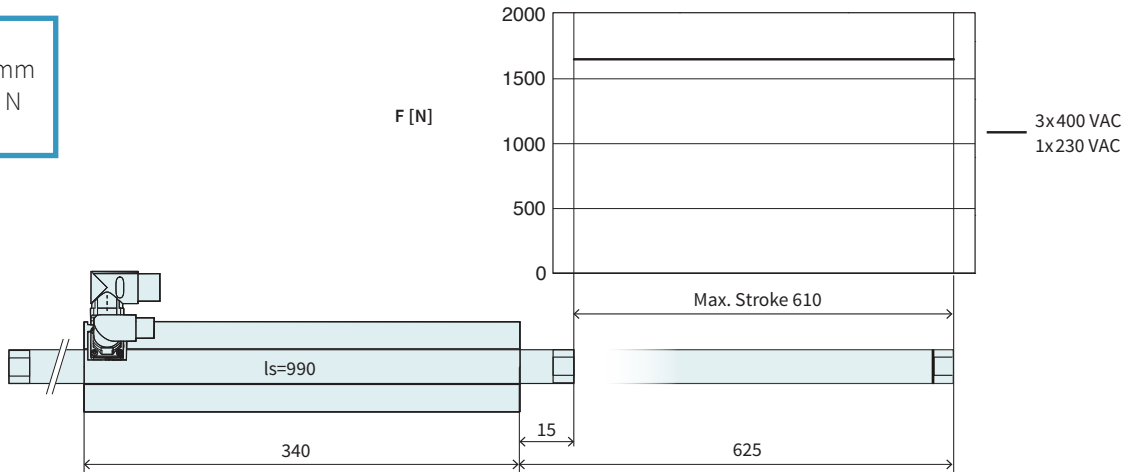

Dimensions in mm

Technical Data P10-70x240U/610			
Stroke			
Max. Stroke	mm (in)		610 (23.99)
Force			
Max. Force ¹ @ 1x230VAC	N (lbf)		1650 (371)
Max. Force ¹ @ 3x400VAC	N (lbf)		1650 (371)
Max. Cont. Force [Passive cooling/ Fan / Fluid]	N (lbf)		190 / 290 / 510 (43 / 66 / 120)
Max. Border Force relative	%		100
Force Constant 1	N/A _{pk} (lbf/A _{pk})		59 (13.3)
Force Constant 2	N/A _{rms} (lbf/A _{rms})		83.4 (18.8)
Velocity			
Max. Velocity @ 1x230VAC	m/s (in/s)		3 (119.9)
Max. Velocity @ 3x400VAC	m/s (in/s)		5.4 (5.4)
Position Detection			
Repeatability	mm (in)		±0.05 (±0.002)
Linearity	%		± 0.2
Electrical Data			
Max. Current ¹ @ 1x230VAC	A _{pk} / A _{rms}		27.9 / 19.7
Max. Current ¹ @ 3x400VAC	A _{pk} / A _{rms}		27.9 / 19.7
Max. Cont. Current 1 [Passive cooling / Fan / Fluid]	A _{pk}		3.3 / 5 / 8.7
Max. Cont. Current 2 [Passive cooling / Fan / Fluid]	A _{rms}		2.3 / 3.5 / 6.1
Thermal Data			
Max. Winding Temperature (Sensor)	°C		90
Thermal Resistance [Passive cooling / Fan / Fluid]	°K/W		0.87 / 0.38 / 0.12
Thermal Time Constant [Passive cooling / Fan / Fluid]	s		2100 / 510 / 110
Mechanical Data			
Slider Length	mm (in)		990 (39)
Slider Mass	g (lb)		4650 (10.23)

¹ Real time calculation of motor winding temperature is required (including monitoring).
 If temperature monitoring is only based on temperature sensor signal (missing thermal model calculation), 60 % of the peak value has to be taken instead.



Item	Description	Item-No.
PS10-70x240U-BL-QJ	Stator 3x400VAC, LinMot Encoder	0150-1293
PS10-70x240U-BL-QJ-D04	Stator 3x400VAC, Sin/Cos Encoder 1Vpp, Pt1000 dual	0150-4262
PS10-70x240U-BL-QJ-D05	Stator 3x400VAC, Sin/Cos Encoder 1Vpp, PTC dual	0150-4607
PS10-70x240U-BL-QJ-D24	Stator 3x400VAC, A/B Encoder 1µm, Pt1000 dual	0150-4132
PS10-70x240U-BL-QJ-D24S	Stator 3x400VAC, A/B Encoder 5µm, Pt1000 dual	0150-4597
PS10-70x240U-BL-QJ-D25	Stator 3x400VAC, A/B Encoder 1µm, PTC dual	0150-5762
PS10-70x240U-BL-QJ-D25S	Stator 3x400VAC, A/B Encoder 5µm, PTC dual	0150-4602
PS10-70x240U-BL-QJ-D26	Stator 3x400VAC, A/B Encoder 1µm, PTC single ended	0150-4516
PS10-70x240U-BL-QJ-D34	Stator 3x400VAC, BiSS-C, Pt1000 dual	0150-4872
PL10-28x990/940	Slider for P10-70 'standard'	0150-2203

P10-70x240U/810-BL-QJ

Max. Stroke: 810 mm
Peak Force: 1650 N

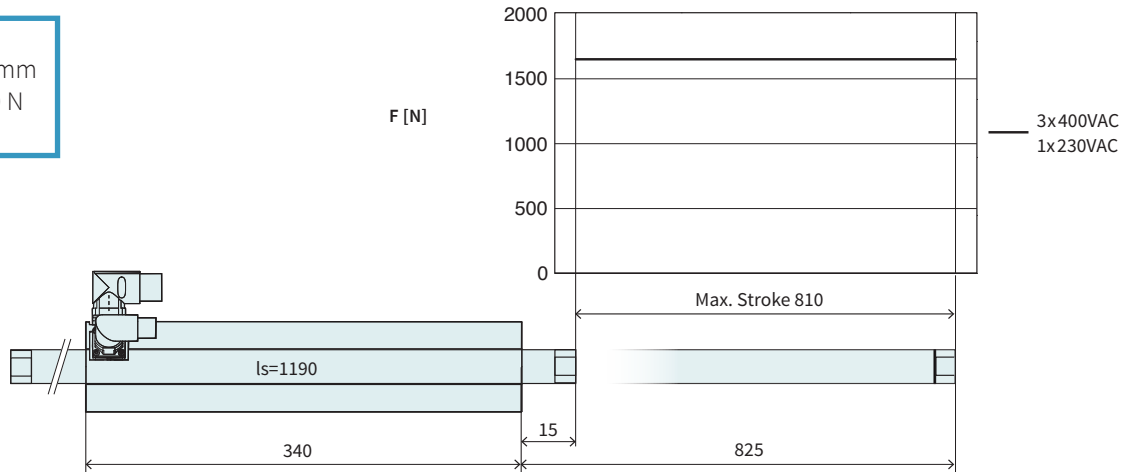

Dimensions in mm

Technical Data P10-70x240U/810			
Stroke			
Max. Stroke	mm (in)	810 (31.89)	
Force			
Max. Force ¹ @ 1x230VAC	N (lbf)	1650 (371)	
Max. Force ¹ @ 3x400VAC	N (lbf)	1650 (371)	
Max. Cont. Force [Passive cooling / Fan / Fluid]	N (lbf)	190 / 290 / 510 (43 / 66 / 120)	
Max. Border Force relative	%	100	
Force Constant 1	N/A _{pk} (lbf/A _{pk})	59 (13.3)	
Force Constant 2	N/A _{rms} (lbf/A _{rms})	83.4 (18.8)	
Velocity			
Max. Velocity @ 1x230VAC	m/s (in/s)	3 (119.9)	
Max. Velocity @ 3x400VAC	m/s (in/s)	5.4 (5.4)	
Position Detection			
Repeatability	mm (in)	±0.05 (±0.002)	
Linearity	%	±0.15	
Electrical Data			
Max. Current ¹ @ 1x230VAC	A _{pk} / A _{rms}	27.9 / 19.7	
Max. Current ¹ @ 3x400VAC	A _{pk} / A _{rms}	27.9 / 19.7	
Max. Cont. Current 1 [Passive cooling / Fan / Fluid]	A _{pk}	3.3 / 5 / 8.7	
Max. Cont. Current 2 [Passive cooling / Fan / Fluid]	A _{rms}	2.3 / 3.5 / 6.1	
Thermal Data			
Max. Winding Temperature (Sensor)	°C	90	
Thermal Resistance [Passive cooling / Fan / Fluid]	°K/W	0.87 / 0.38 / 0.12	
Thermal Time Constant [Passive cooling / Fan / Fluid]	s	2100 / 510 / 110	
Mechanical Data			
Slider Length	mm (in)	1190 (47)	
Slider Mass	g (lb)	5590 (12.3)	

¹ Real time calculation of motor winding temperature is required (including monitoring).
 If temperature monitoring is only based on temperature sensor signal (missing thermal model calculation), 60 % of the peak value has to be taken instead.



Item	Description	Item-No.
PS10-70x240U-BL-QJ	Stator 3x400VAC, LinMot Encoder	0150-1293
PS10-70x240U-BL-QJ-D04	Stator 3x400VAC, Sin/Cos Encoder 1Vpp, Pt1000 dual	0150-4262
PS10-70x240U-BL-QJ-D05	Stator 3x400VAC, Sin/Cos Encoder 1Vpp, PTC dual	0150-4607
PS10-70x240U-BL-QJ-D24	Stator 3x400VAC, A/B Encoder 1µm, Pt1000 dual	0150-4132
PS10-70x240U-BL-QJ-D24S	Stator 3x400VAC, A/B Encoder 5µm, Pt1000 dual	0150-4597
PS10-70x240U-BL-QJ-D25	Stator 3x400VAC, A/B Encoder 1µm, PTC dual	0150-5762
PS10-70x240U-BL-QJ-D25S	Stator 3x400VAC, A/B Encoder 5µm, PTC dual	0150-4602
PS10-70x240U-BL-QJ-D26	Stator 3x400VAC, A/B Encoder 1µm, PTC single ended	0150-4516
PS10-70x240U-BL-QJ-D34	Stator 3x400VAC, BiSS-C, Pt1000 dual	0150-4872
PL10-28x1190/1140	Slider for P10-70 'standard'	0150-2204

P10-70x240U/1010-BL-QJ

Max. Stroke: 1010 mm
Peak Force: 1650 N

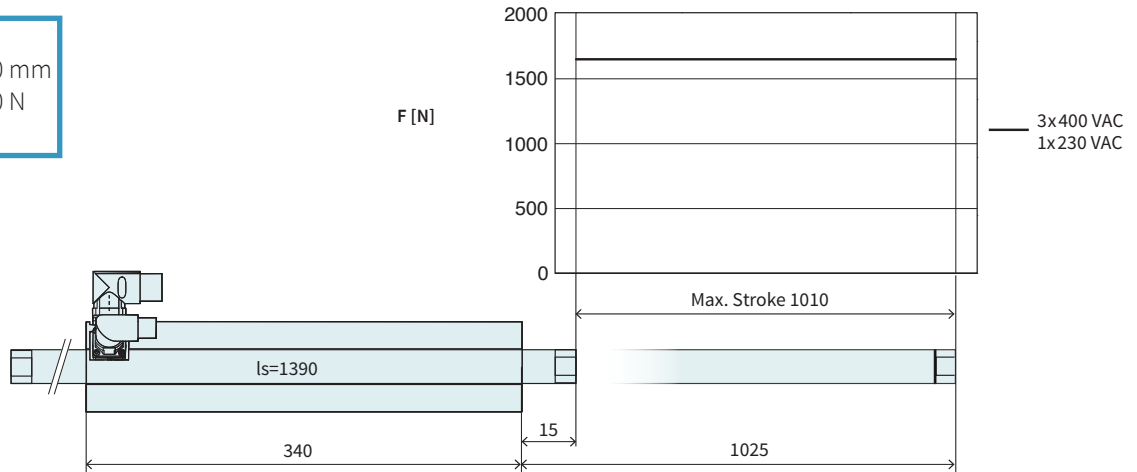

Technical Data P10-70x240U/1010

Stroke			
Max. Stroke	mm (in)	1010 (39.79)	
Force			
Max. Force ¹ @ 1x230VAC	N (lbf)	1650 (371)	
Max. Force ¹ @ 3x400VAC	N (lbf)	1650 (371)	
Max. Cont. Force [Passive cooling / Fan / Fluid]	N (lbf)	190 / 290 / 510 (43 / 66 / 120)	
Max. Border Force relative	%	100	
Force Constant 1	N/A _{pk} (lbf/A _{pk})	59 (13.3)	
Force Constant 2	N/A _{rms} (lbf/A _{rms})	83.4 (18.8)	
Velocity			
Max. Velocity @ 1x230VAC	m/s (in/s)	3 (119.9)	
Max. Velocity @ 3x400VAC	m/s (in/s)	5.4 (5.4)	
Position Detection			
Repeatability	mm (in)	±0.05 (±0.002)	
Linearity	%	± 0.15	
Electrical Data			
Max. Current ¹ @ 1x230VAC	A _{pk} / A _{rms}	27.9 / 19.7	
Max. Current ¹ @ 3x400VAC	A _{pk} / A _{rms}	27.9 / 19.7	
Max. Cont. Current 1 [Passive cooling / Fan / Fluid]	A _{pk}	3.3 / 5 / 8.7	
Max. Cont. Current 2 [Passive cooling / Fan / Fluid]	A _{rms}	2.3 / 3.5 / 6.1	
Thermal Data			
Max. Winding Temperature (Sensor)	°C	90	
Thermal Resistance [Passive cooling / Fan / Fluid]	°K/W	0.87 / 0.38 / 0.12	
Thermal Time Constant [Passive cooling / Fan / Fluid]	s	2100 / 510 / 110	
Mechanical Data			
Slider Length	mm (in)	1390 (55)	
Slider Mass	g (lb)	6530 (14.37)	

1) Real time calculation of motor winding temperature is required (including monitoring).
 If temperature monitoring is only based on temperature sensor signal (missing thermal model calculation), 60 % of the peak value has to be taken instead.

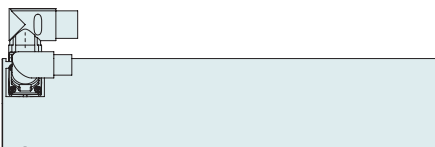

Item	Description	Item-No.
PS10-70x240U-BL-QJ	Stator 3x400VAC, LinMot Encoder	0150-1293
PS10-70x240U-BL-QJ-D04	Stator 3x400VAC, Sin/Cos Encoder 1Vpp, Pt1000 dual	0150-4262
PS10-70x240U-BL-QJ-D05	Stator 3x400VAC, Sin/Cos Encoder 1Vpp, PTC dual	0150-4607
PS10-70x240U-BL-QJ-D24	Stator 3x400VAC, A/B Encoder 1µm, Pt1000 dual	0150-4132
PS10-70x240U-BL-QJ-D24S	Stator 3x400VAC, A/B Encoder 5µm, Pt1000 dual	0150-4597
PS10-70x240U-BL-QJ-D25	Stator 3x400VAC, A/B Encoder 1µm, PTC dual	0150-5762
PS10-70x240U-BL-QJ-D25S	Stator 3x400VAC, A/B Encoder 5µm, PTC dual	0150-4602
PS10-70x240U-BL-QJ-D26	Stator 3x400VAC, A/B Encoder 1µm, PTC single ended	0150-4516
PS10-70x240U-BL-QJ-D34	Stator 3x400VAC, BiSS-C, Pt1000 dual	0150-4872
PL10-28x1390/1340	Slider for P10-70 'standard'	0150-2205

P10-70x240U/1210-BL-QJ

Max. Stroke: 1210 mm
Peak Force: 1650 N

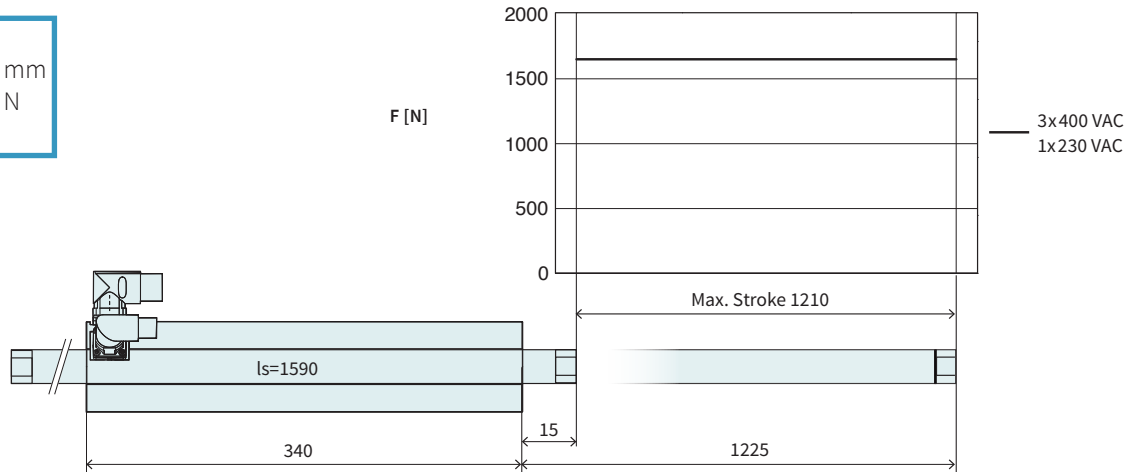

Dimensions in mm

Technical Data P10-70x240U/1210			
Stroke			
Max. Stroke	mm (in)	1210 (47.6)	
Force			
Max. Force ¹ @ 1x230VAC	N (lbf)	1650 (371)	
Max. Force ¹ @ 3x400VAC	N (lbf)	1650 (371)	
Max. Cont. Force [Passive cooling / Fan / Fluid]	N (lbf)	190 / 290 / 510 (43 / 66 / 120)	
Max. Border Force relative	%	100	
Force Constant 1	N/A _{pk} (lbf/A _{pk})	59 (13.3)	
Force Constant 2	N/A _{rms} (lbf/A _{rms})	83.4 (18.8)	
Velocity			
Max. Velocity @ 1x230VAC	m/s (in/s)	3 (119.9)	
Max. Velocity @ 3x400VAC	m/s (in/s)	5.4 (5.4)	
Position Detection			
Repeatability	mm (in)	±0.05 (±0.002)	
Linearity	%	±0.15	
Electrical Data			
Max. Current ¹ @ 1x230VAC	A _{pk} / A _{rms}	27.9 / 19.7	
Max. Current ¹ @ 3x400VAC	A _{pk} / A _{rms}	27.9 / 19.7	
Max. Cont. Current 1 [Passive cooling / Fan / Fluid]	A _{pk}	3.3 / 5 / 8.7	
Max. Cont. Current 2 [Passive cooling / Fan / Fluid]	A _{rms}	2.3 / 3.5 / 6.1	
Thermal Data			
Max. Winding Temperature (Sensor)	°C	90	
Thermal Resistance [Passive cooling / Fan / Fluid]	°K/W	0.87 / 0.38 / 0.12	
Thermal Time Constant [Passive cooling / Fan / Fluid]	s	2100 / 510 / 110	
Mechanical Data			
Slider Length	mm (in)	1590 (63)	
Slider Mass	g (lb)	7470 (16.43)	

¹) Real time calculation of motor winding temperature is required (including monitoring).
 If temperature monitoring is only based on temperature sensor signal (missing thermal model calculation), 60 % of the peak value has to be taken instead.



Item	Description	Item-No.
PS10-70x240U-BL-QJ	Stator 3x400VAC, LinMot Encoder	0150-1293
PS10-70x240U-BL-QJ-D04	Stator 3x400VAC, Sin/Cos Encoder 1Vpp, Pt1000 dual	0150-4262
PS10-70x240U-BL-QJ-D05	Stator 3x400VAC, Sin/Cos Encoder 1Vpp, PTC dual	0150-4607
PS10-70x240U-BL-QJ-D24	Stator 3x400VAC, A/B Encoder 1µm, Pt1000 dual	0150-4132
PS10-70x240U-BL-QJ-D24S	Stator 3x400VAC, A/B Encoder 5µm, Pt1000 dual	0150-4597
PS10-70x240U-BL-QJ-D25	Stator 3x400VAC, A/B Encoder 1µm, PTC dual	0150-5762
PS10-70x240U-BL-QJ-D25S	Stator 3x400VAC, A/B Encoder 5µm, PTC dual	0150-4602
PS10-70x240U-BL-QJ-D26	Stator 3x400VAC, A/B Encoder 1µm, PTC single ended	0150-4516
PS10-70x240U-BL-QJ-D34	Stator 3x400VAC, BiSS-C, Pt1000 dual	0150-4872
PL10-28x1590/1540	Slider for P10-70 'standard'	0150-2206

P10-70x240U/1410-BL-QJ

Max. Stroke: 1410 mm
Peak Force: 1650 N

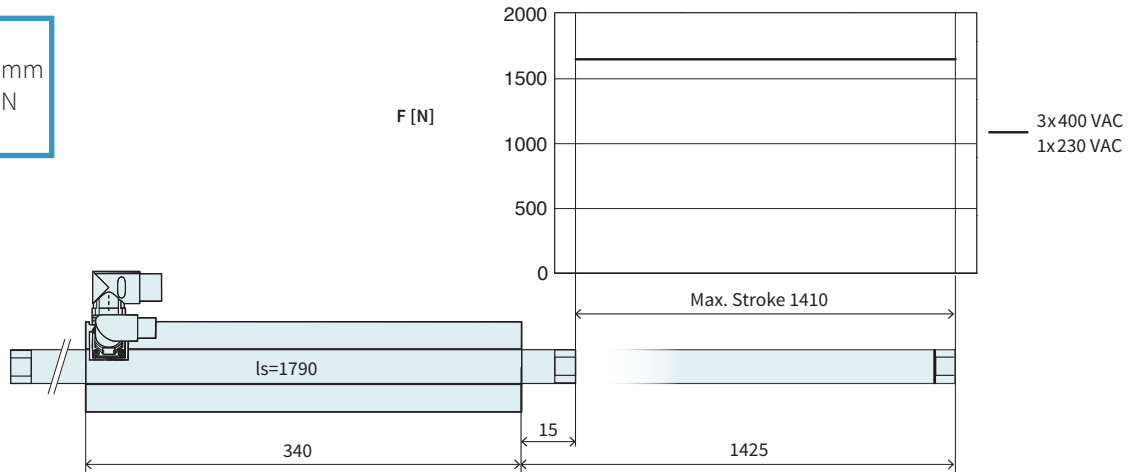

Dimensions in mm

Technical Data P10-70x240U/1410			
Stroke			
Max. Stroke	mm (in)		1410 (55.49)
Force			
Max. Force ¹ @ 1x230VAC	N (lbf)		1650 (371)
Max. Force ¹ @ 3x400VAC	N (lbf)		1650 (371)
Max. Cont. Force [Passive cooling / Fan / Fluid]	N (lbf)		190 / 290 / 510 (43 / 66 / 120)
Max. Border Force relative	%		100
Force Constant 1	N/A _{pk} (lbf/A _{pk})		59 (13.3)
Force Constant 2	N/A _{rms} (lbf/A _{rms})		83.4 (18.8)
Velocity			
Max. Velocity @ 1x230VAC	m/s (in/s)		3 (119.9)
Max. Velocity @ 3x400VAC	m/s (in/s)		5.4 (5.4)
Position Detection			
Repeatability	mm (in)		±0.05 (±0.002)
Linearity	%		± 0.15
Electrical Data			
Max. Current ¹ @ 1x230VAC	A _{pk} / A _{rms}		27.9 / 19.7
Max. Current ¹ @ 3x400VAC	A _{pk} / A _{rms}		27.9 / 19.7
Max. Cont. Current 1 [Passive cooling / Fan / Fluid]	A _{pk}		3.3 / 5 / 8.7
Max. Cont. Current 2 [Passive cooling / Fan / Fluid]	A _{rms}		2.3 / 3.5 / 6.1
Thermal Data			
Max. Winding Temperature (Sensor)	°C		90
Thermal Resistance [Passive cooling / Fan / Fluid]	°K/W		0.87 / 0.38 / 0.12
Thermal Time Constant [Passive cooling / Fan / Fluid]	s		2100 / 510 / 110
Mechanical Data			
Slider Length	mm (in)		1790 (70)
Slider Mass	g (lb)		8413 (18.51)

1) Real time calculation of motor winding temperature is required (including monitoring).
 If temperature monitoring is only based on temperature sensor signal (missing thermal model calculation), 60 % of the peak value has to be taken instead.



Item	Description	Item-No.
PS10-70x240U-BL-QJ	Stator 3x400VAC, LinMot Encoder	0150-1293
PS10-70x240U-BL-QJ-D04	Stator 3x400VAC, Sin/Cos Encoder 1Vpp, Pt1000 dual	0150-4262
PS10-70x240U-BL-QJ-D05	Stator 3x400VAC, Sin/Cos Encoder 1Vpp, PTC dual	0150-4607
PS10-70x240U-BL-QJ-D24	Stator 3x400VAC, A/B Encoder 1µm, Pt1000 dual	0150-4132
PS10-70x240U-BL-QJ-D24S	Stator 3x400VAC, A/B Encoder 5µm, Pt1000 dual	0150-4597
PS10-70x240U-BL-QJ-D25	Stator 3x400VAC, A/B Encoder 1µm, PTC dual	0150-5762
PS10-70x240U-BL-QJ-D25S	Stator 3x400VAC, A/B Encoder 5µm, PTC dual	0150-4602
PS10-70x240U-BL-QJ-D26	Stator 3x400VAC, A/B Encoder 1µm, PTC single ended	0150-4516
PS10-70x240U-BL-QJ-D34	Stator 3x400VAC, BiSS-C, Pt1000 dual	0150-4872
PL10-28x1790/1740	Slider for P10-70 'standard'	0150-2207

P10-70x240U/1610-BL-QJ

Max. Stroke: 1610 mm
Peak Force: 1650 N

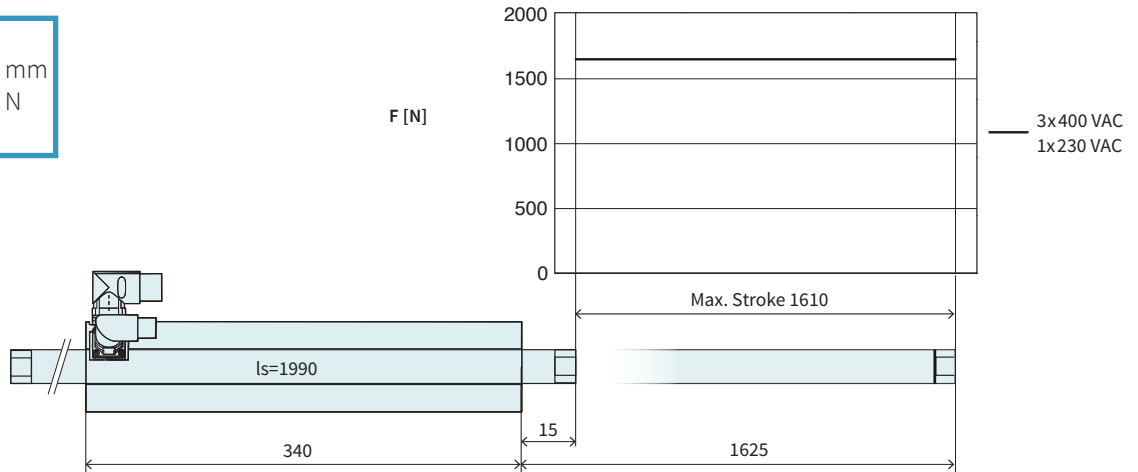

Dimensions in mm

Technical Data P10-70x240U/1610			
Stroke			
Max. Stroke	mm (in)	1610 (63.39)	
Force			
Max. Force ¹ @ 1x230VAC	N (lbf)	1650 (371)	
Max. Force ¹ @ 3x400VAC	N (lbf)	1650 (371)	
Max. Cont. Force [Passive cooling / Fan / Fluid]	N (lbf)	190 / 290 / 510 (43 / 66 / 120)	
Max. Border Force relative	%	100	
Force Constant 1	N/A _{pk} (lbf/A _{pk})	59 (13.3)	
Force Constant 2	N/A _{rms} (lbf/A _{rms})	83.4 (18.8)	
Velocity			
Max. Velocity @ 1x230VAC	m/s (in/s)	3 (119.9)	
Max. Velocity @ 3x400VAC	m/s (in/s)	5.4 (5.4)	
Position Detection			
Repeatability	mm (in)	±0.05 (±0.002)	
Linearity	%	±0.15	
Electrical Data			
Max. Current ¹ @ 1x230VAC	A _{pk} / A _{rms}	27.9 / 19.7	
Max. Current ¹ @ 3x400VAC	A _{pk} / A _{rms}	27.9 / 19.7	
Max. Cont. Current 1 [Passive cooling / Fan / Fluid]	A _{pk}	3.3 / 5 / 8.7	
Max. Cont. Current 2 [Passive cooling / Fan / Fluid]	A _{rms}	2.3 / 3.5 / 6.1	
Thermal Data			
Max. Winding Temperature (Sensor)	°C	90	
Thermal Resistance [Passive cooling / Fan / Fluid]	°K/W	0.87 / 0.38 / 0.12	
Thermal Time Constant [Passive cooling / Fan / Fluid]	s	2100 / 510 / 110	
Mechanical Data			
Slider Length	mm (in)	1990 (78)	
Slider Mass	g (lb)	9350 (20.57)	

1) Real time calculation of motor winding temperature is required (including monitoring).
 If temperature monitoring is only based on temperature sensor signal (missing thermal model calculation), 60 % of the peak value has to be taken instead.



Item	Description	Item-No.
PS10-70x240U-BL-QJ	Stator 3x400VAC, LinMot Encoder	0150-1293
PS10-70x240U-BL-QJ-D04	Stator 3x400VAC, Sin/Cos Encoder 1Vpp, Pt1000 dual	0150-4262
PS10-70x240U-BL-QJ-D05	Stator 3x400VAC, Sin/Cos Encoder 1Vpp, PTC dual	0150-4607
PS10-70x240U-BL-QJ-D24	Stator 3x400VAC, A/B Encoder 1µm, Pt1000 dual	0150-4132
PS10-70x240U-BL-QJ-D24S	Stator 3x400VAC, A/B Encoder 5µm, Pt1000 dual	0150-4597
PS10-70x240U-BL-QJ-D25	Stator 3x400VAC, A/B Encoder 1µm, PTC dual	0150-5762
PS10-70x240U-BL-QJ-D25S	Stator 3x400VAC, A/B Encoder 5µm, PTC dual	0150-4602
PS10-70x240U-BL-QJ-D26	Stator 3x400VAC, A/B Encoder 1µm, PTC single ended	0150-4516
PS10-70x240U-BL-QJ-D34	Stator 3x400VAC, BiSS-C, Pt1000 dual	0150-4872
PL10-28x1990/1940	Läufer für P10-70 'standard'	0150-2208

Linear Guides H10



4

HM10-70x240/110 Linear Module 70x240 with 110 mm Stroke

→	H-Guide	H10-70x240/110	H-Guide for P10-70x240, Stroke max. 110 mm	0150-5185	
	→	Stator	PS10-70x240U-BL-QJ	Stator 3x400VAC, LinMot Encoder	0150-1293
			PS10-70x240U-BL-QJ-D04	Stator 3x400VAC, Sin/Cos Encoder 1Vpp, Pt1000 dual	0150-4262
			PS10-70x240U-BL-QJ-D05	Stator 3x400VAC, Sin/Cos Encoder 1Vpp, PTC dual	0150-4607
			PS10-70x240U-BL-QJ-D24	Stator 3x400VAC, A/B Encoder 1µm, Pt1000 dual	0150-4132
			PS10-70x240U-BL-QJ-D24S	Stator 3x400VAC, A/B Encoder 5µm, Pt1000 dual	0150-4597
			PS10-70x240U-BL-QJ-D25	Stator 3x400VAC, A/B Encoder 1µm, PTC dual	0150-5762
			PS10-70x240U-BL-QJ-D25S	Stator 3x400VAC, A/B Encoder 5µm, PTC dual	0150-4602
			PS10-70x240U-BL-QJ-D26	Stator 3x400VAC, A/B Encoder 1µm, PTC single ended	0150-4516
	PS10-70x240U-BL-QJ-D34	Stator 3x400VAC, BiSS-C, Pt1000 dual	0150-4872		
→	Slider	PL10-28x490/440	Slider for P10-70 'standard'	0150-2195	

HM10-70x240/210 Linear Module 70x240 with 210 mm Stroke

→	H-Guide	H10-70x240/210	H-Guide for P10-70x240, Stroke max. 210 mm	0150-5400	
	→	Stator	PS10-70x240U-BL-QJ	Stator 3x400VAC, LinMot Encoder	0150-1293
			PS10-70x240U-BL-QJ-D04	Stator 3x400VAC, Sin/Cos Encoder 1Vpp, Pt1000 dual	0150-4262
			PS10-70x240U-BL-QJ-D05	Stator 3x400VAC, Sin/Cos Encoder 1Vpp, PTC dual	0150-4607
			PS10-70x240U-BL-QJ-D24	Stator 3x400VAC, A/B Encoder 1µm, Pt1000 dual	0150-4132
			PS10-70x240U-BL-QJ-D24S	Stator 3x400VAC, A/B Encoder 5µm, Pt1000 dual	0150-4597
			PS10-70x240U-BL-QJ-D25	Stator 3x400VAC, A/B Encoder 1µm, PTC dual	0150-5762
			PS10-70x240U-BL-QJ-D25S	Stator 3x400VAC, A/B Encoder 5µm, PTC dual	0150-4602
			PS10-70x240U-BL-QJ-D26	Stator 3x400VAC, A/B Encoder 1µm, PTC single ended	0150-4516
	PS10-70x240U-BL-QJ-D34	Stator 3x400VAC, BiSS-C, Pt1000 dual	0150-4872		
→	Slider	PL10-28x590/540	Slider for P10-70 'standard'	0150-2196	

HM10-70x240/310 Linear Module 70x240 with 310 mm Stroke

→	H-Guide	H10-70x240/310	H-Guide for P10-70x240, Stroke max. 310 mm	0150-5401	
	→	Stator	PS10-70x240U-BL-QJ	Stator 3x400VAC, LinMot Encoder	0150-1293
			PS10-70x240U-BL-QJ-D04	Stator 3x400VAC, Sin/Cos Encoder 1Vpp, Pt1000 dual	0150-4262
			PS10-70x240U-BL-QJ-D05	Stator 3x400VAC, Sin/Cos Encoder 1Vpp, PTC dual	0150-4607
			PS10-70x240U-BL-QJ-D24	Stator 3x400VAC, A/B Encoder 1µm, Pt1000 dual	0150-4132
			PS10-70x240U-BL-QJ-D24S	Stator 3x400VAC, A/B Encoder 5µm, Pt1000 dual	0150-4597
			PS10-70x240U-BL-QJ-D25	Stator 3x400VAC, A/B Encoder 1µm, PTC dual	0150-5762
			PS10-70x240U-BL-QJ-D25S	Stator 3x400VAC, A/B Encoder 5µm, PTC dual	0150-4602
			PS10-70x240U-BL-QJ-D26	Stator 3x400VAC, A/B Encoder 1µm, PTC single ended	0150-4516
	PS10-70x240U-BL-QJ-D34	Stator 3x400VAC, BiSS-C, Pt1000 dual	0150-4872		
→	Slider	PL10-28x690/640	Slider for P10-70 'standard'	0150-2197	

HM10-70x240/410		Linear Module 70x240 with 410 mm Stroke			
→	H-Guide	H10-70x240/410	H-Guide for P10-70x240, Stroke max. 410 mm	0150-5402	
	→	Stator	PS10-70x240U-BL-QJ	Stator 3x400VAC, LinMot Encoder	0150-1293
			PS10-70x240U-BL-QJ-D04	Stator 3x400VAC, Sin/Cos Encoder 1Vpp, Pt1000 dual	0150-4262
			PS10-70x240U-BL-QJ-D05	Stator 3x400VAC, Sin/Cos Encoder 1Vpp, PTC dual	0150-4607
			PS10-70x240U-BL-QJ-D24	Stator 3x400VAC, A/B Encoder 1µm, Pt1000 dual	0150-4132
			PS10-70x240U-BL-QJ-D24S	Stator 3x400VAC, A/B Encoder 5µm, Pt1000 dual	0150-4597
			PS10-70x240U-BL-QJ-D25	Stator 3x400VAC, A/B Encoder 1µm, PTC dual	0150-5762
			PS10-70x240U-BL-QJ-D25S	Stator 3x400VAC, A/B Encoder 5µm, PTC dual	0150-4602
			PS10-70x240U-BL-QJ-D26	Stator 3x400VAC, A/B Encoder 1µm, PTC single ended	0150-4516
	PS10-70x240U-BL-QJ-D34	Stator 3x400VAC, BiSS-C, Pt1000 dual	0150-4872		
→	Slider	PL10-28x790/740	Slider for P10-70 'standard'	0150-2198	
HM10-70x240/510		Linear Module 70x240 with 510 mm Stroke			
→	H-Guide	H10-70x240/510	H-Guide for P10-70x240, Stroke max. 510 mm	0150-5403	
	→	Stator	PS10-70x240U-BL-QJ	Stator 3x400VAC, LinMot Encoder	0150-1293
			PS10-70x240U-BL-QJ-D04	Stator 3x400VAC, Sin/Cos Encoder 1Vpp, Pt1000 dual	0150-4262
			PS10-70x240U-BL-QJ-D05	Stator 3x400VAC, Sin/Cos Encoder 1Vpp, PTC dual	0150-4607
			PS10-70x240U-BL-QJ-D24	Stator 3x400VAC, A/B Encoder 1µm, Pt1000 dual	0150-4132
			PS10-70x240U-BL-QJ-D24S	Stator 3x400VAC, A/B Encoder 5µm, Pt1000 dual	0150-4597
			PS10-70x240U-BL-QJ-D25	Stator 3x400VAC, A/B Encoder 1µm, PTC dual	0150-5762
			PS10-70x240U-BL-QJ-D25S	Stator 3x400VAC, A/B Encoder 5µm, PTC dual	0150-4602
			PS10-70x240U-BL-QJ-D26	Stator 3x400VAC, A/B Encoder 1µm, PTC single ended	0150-4516
	PS10-70x240U-BL-QJ-D34	Stator 3x400VAC, BiSS-C, Pt1000 dual	0150-4872		
→	Slider	PL10-28x890/840	Slider for P10-70 'standard'	0150-2199	
Accessories					
→	Fan	HV01-37/48	Fan cooling for H01-37/48 & PF02-37/48	0150-5051	

4

Motor Cable

4

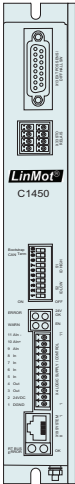

C1400

B Connector MC10-B/m

Q Connector MC10-Q/f

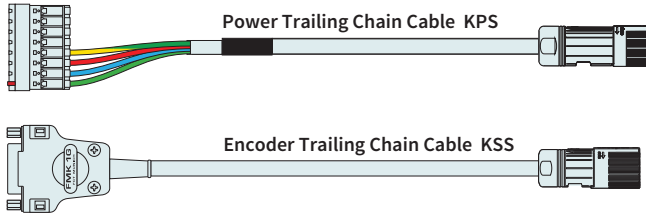

P10-70x240U

D15 Connector MC01-D15/f

J Connector MC10-J/f



E1400

L Connector MC10-L/m

Q Connector MC10-Q/f

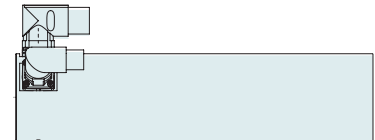
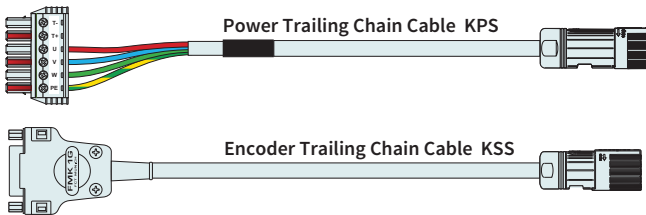

P10-70x240U

D15 Connector MC01-D15/f

J Connector MC10-J/f

ORDERING INFORMATION

POWER CABLES		
Item	Description	Item-No.
KPS15-04-L/Q-3	Power Trailing Chain Cable E1400/P10-70, 3 m	0150-2266
KPS15-04-L/Q-5	Power Trailing Chain Cable E1400/P10-70, 5 m	0150-2261
KPS15-04-L/Q-8	Power Trailing Chain Cable E1400/P10-70, 8 m	0150-2267
KPS15-04-L/Q-12	Power Trailing Chain Cable E1400/P10-70, 12 m	0150-2268
KPS15-04-L/Q-	Power Trailing Chain Cable L/Q-, Custom length	0150-3388
KPS15-04-B/Q-3	Power Trailing Chain Cable C1400/P10-70, 3 m	0150-3660
KPS15-04-B/Q-5	Power Trailing Chain Cable C1400/P10-70, 5 m	0150-3661
KPS15-04-B/Q-8	Power Trailing Chain Cable C1400/P10-70, 8 m	0150-3662
KPS15-04-B/Q-12	Power Trailing Chain Cable C1400/P10-70, 12 m	0150-3663
KPS15-04-B/Q-	Power Trailing Chain Cable B/Q-, Custom length	0150-3608
ENCODER CABLES		
Item	Description	Item-No.
KSS05-02/08-D15/J-3	Encoder Trailing Chain Cable D15/J, 3 m	0150-2263
KSS05-02/08-D15/J-5	Encoder Trailing Chain Cable D15/J, 5 m	0150-2262
KSS05-02/08-D15/J-8	Encoder Trailing Chain Cable D15/J, 8 m	0150-2264
KSS05-02/08-D15/J-12	Encoder Trailing Chain Cable D15/J, 12 m	0150-2265
KSS05-02/08-D15(f)-45°/J-	Encoder Trailing Chain Cable D15/J-, Custom length	0150-3389
EXTENSION CABLES		
Item	Description	Item-No.
KPS15-04-Q/Q-	Power Trailing Chain Cable Q/Q-, Custom length	0150-3414
KSS05-02/08-J/J-	Encoder Trailing Chain Cable J/J-, Custom length	0150-3415
CONNECTORS		
Item	Description	Item-No.
MC10-L/m	Connector Power E1400/X2	0150-3382
MC01-D15/f	Motor Connector D15 (f)	0150-3136
MC10-Q/f	Connector Power PS10-70	0150-2268
MC10-J/f	Connector Encoder PS10-70	0150-2269

Motor Cables for 3rd Party Drives

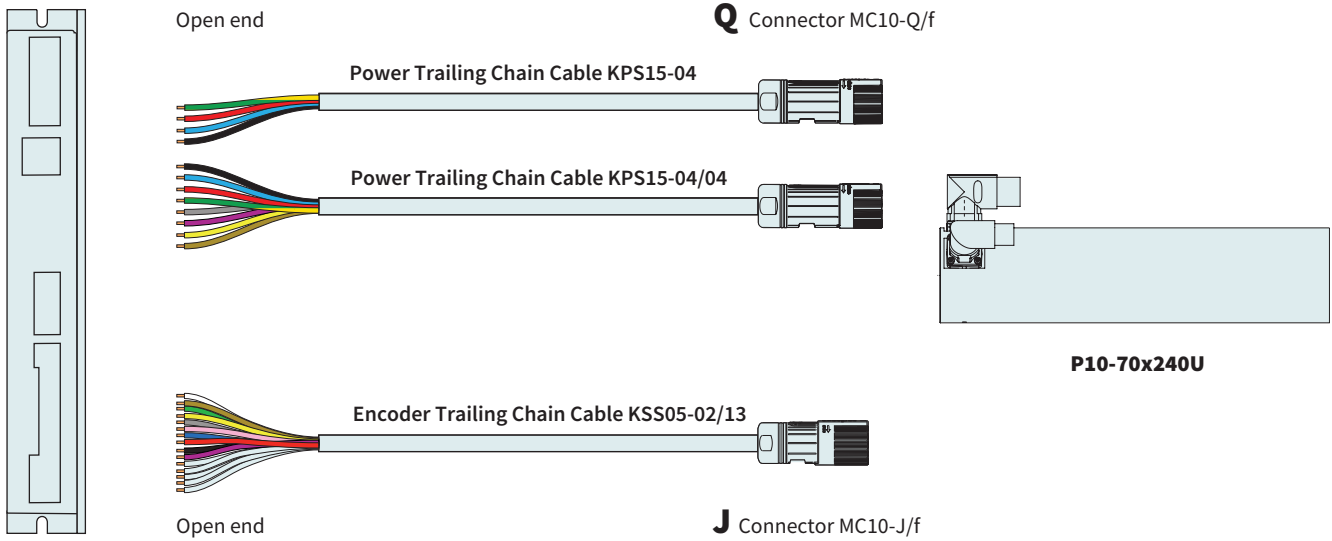

ORDER OVERVIEW

Motor-Interface	Power Cable	Encoder Cable	PosFeedback	TempFeedback via Power Cable	TempFeedback via Encoder Cable	Halls witch Signals	Reference Signal
D04	KPS15-04-_/Q-...	KSS05-02/13-_/J-...	Sin/Cos 1Vpp	---	Pt1000	Hall U/V/W	Ref
	KPS15-04/04-_/Q-...	KSS05-02/13-_/J-...	Sin/Cos 1Vpp	Pt1000	Pt1000	Hall U/V/W	Ref
D05	KPS15-04-_/Q-...	KSS05-02/13-_/J-...	Sin/Cos 1Vpp	---	PTC	Hall U/V/W	Ref
	KPS15-04/04-_/Q-...	KSS05-02/13-_/J-...	Sin/Cos 1Vpp	PTC	PTC	Hall U/V/W	Ref
D24	KPS15-04-_/Q-...	KSS05-02/13-_/J-...	A/B 1µm	---	Pt1000	Hall U/V/W	Ref
	KPS15-04/04-_/Q-...	KSS05-02/13-_/J-...	A/B 1µm	Pt1000	Pt1000	Hall U/V/W	Ref
D24S	KPS15-04-_/Q-...	KSS05-02/13-_/J-...	A/B 5µm	---	Pt1000	Hall U/V/W	Ref
	KPS15-04/04-_/Q-...	KSS05-02/13-_/J-...	A/B 5µm	Pt1000	Pt1000	Hall U/V/W	Ref
D25	KPS15-04-_/Q-...	KSS05-02/13-_/J-...	A/B 1µm	---	PTC	Hall U/V/W	Ref
	KPS15-04/04-_/Q-...	KSS05-02/13-_/J-...	A/B 1µm	PTC	PTC	Hall U/V/W	Ref
D25S	KPS15-04-_/Q-...	KSS05-02/13-_/J-...	A/B 5µm	---	PTC	Hall U/V/W	Ref
	KPS15-04/04-_/Q-...	KSS05-02/13-_/J-...	A/B 5µm	PTC	PTC	Hall U/V/W	Ref
D26	KPS15-04-_/Q-...	KSS05-02/13-_/J-...	A/B 1µm	---	PTC SE	Hall U/V/W	Ref
	KPS15-04/04-_/Q-...	KSS05-02/13-_/J-...	A/B 1µm	PTC SE	PTC SE	Hall U/V/W	Ref
D34	KPS15-04-_/Q-...	KSS05-02/13-_/J-...	BiSS-C	---	Pt1000	Hall U/V/W	---
	KPS15-04/04-_/Q-...	KSS05-02/13-_/J-...	BiSS-C	Pt1000	---	Hall U/V/W	---

ORDERING INFORMATION

POWER CABLES		
Item	Description	Item-No.
KPS15-04-.../Q-10	Power Trailing Chain Cable .../Q, 10 m for Dxx	0150-2376
KPS15-04-./Q-	Power Trailing Chain Cable .../Q, für Dxx, Custom length	0150-3491
KPS15-04	Power Trailing Chain Cable P10-70 (per m)	0150-2257
KPS15-04/04.../Q-10	Power Trailing Chain Cable .../Q, 10 m for Dxx	0150-3654
KPS15-04/04-./Q-	Power Trailing Chain Cable .../Q, für Dxx, Custom length	0150-3579
KPS15-04/04	Power Trailing Chain Cable P10-...-Dxx (per m)	0150-2269

ENCODER CABLES		
Item	Description	Item-No.
KSS05-02/13-.../J-10	Encoder Trailing Chain Cable .../J, 10 m for Dxx	0150-2377
KSS05-02/13-./J-	Encoder Trailing Chain Cable ./J, für Dxx, Custom length	0150-3492
KSS05-02/13	Encoder Trailing Chain Cable P10-...-Dxx (per m)	0150-2259

EXTENSION CABLES		
Item	Description	Item-No.
KPS15-04-Q/Q-	Power Trailing Chain Cable Q/Q-, Custom length	0150-3414
KPS15-04/04-Q/Q-	Power Trailing Chain Cable Q/Q-, Custom length	0150-4214
KSS05-02/13-J/J-	Encoder Trailing Chain Cable J/J, für Dxx, Custom length	0150-3996

CONNECTORS		
Item	Description	Item-No.
MC10-Q/f	Connector Power PS10-70	0150-2268
MC10-J/f	Connector Encoder PS10-70	0150-2269

MOTOR FLANGES

4



Item	Description	Item-No.
PF10-70x270	Flange for PS10-70x240	0150-2274



Item	Description	Item-No.
PF11-70x270-FC	Flange for PS10-70x240 fluid cooling	0150-2824

FIND MORE PRODUCT DETAILS IN THE CHAPTER "ACCESSORIES".

FANS



Item	Description	Item-No.
HV01-37/48	Fan cooling for H01-37/48 & PF02-37/48	0150-5051

FIND MORE PRODUCT DETAILS IN THE CHAPTER "ACCESSORIES".

SLIDER MOUNTING



Item	Description	Item-No.
PLF01-28	Fixed Bearing Set for 27/28 mm sliders	0150-3087
PLF01-28-SS	Fixed Bearing Set for 27/28 mm sliders, stainless steel	0150-3297
PLL01-28	Floating Bearing for 28 mm sliders	0150-3094
PLM01-28-MK	Mounting Kit for 28 mm sliders	0150-3095

FIND MORE PRODUCT DETAILS IN THE CHAPTER "ACCESSORIES".

BEARING KIT



Item	Description	Item-No.
PB10-70x240-L	Bearing Kit for PS10-70x240	0150-3433

FIND MORE PRODUCT DETAILS IN THE CHAPTER "ACCESSORIES".

LUBRICANT RESERVOIR



Item	Description	Item-No.
PA10-70/28	Lubricant reservoir for PS10-70 with lubricating nipple	0150-3543

FIND MORE PRODUCT DETAILS IN THE CHAPTER "ACCESSORIES".

EXTERNAL POSITION SENSORS

4

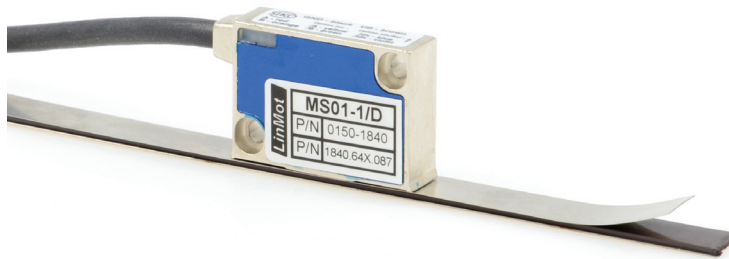

Item	Description	Item-No.
MS01-1/D	Linear Encoder 1µm, A/B (for incremental strip)	0150-1840
MB01-1000	Magnetic incremental strip for MS01-1/D, per cm	0150-1963
KS025-D15/D-Encoder	Encoder Cable (Length in m)	0150-3168

FIND MORE PRODUCT DETAILS IN THE CHAPTER "ACCESSORIES".



Item	Description	Item-No.
MS01-1/D-SSI	Linear Encoder 1µm, A/B (for absolute strip)	0150-2095
MB01-1000-ABS	Magnetic absolute strip for MS01-1/D-SSI (per cm)	0150-2096
EC01-ABS/ENC-12-S	MS01-1/D-SSI Encoder connector straight	0150-3616
KSS01-12-D15/ABS-ENC	Special cable for MS01-1/D-SSI on C1100/C1200/C1400/E1200/E1400 Drives	0150-3652

FIND MORE PRODUCT DETAILS IN THE CHAPTER "ACCESSORIES".

Area with horizontal dotted lines for notes.