

LINEAR MOTORS P01-48X360F-EX

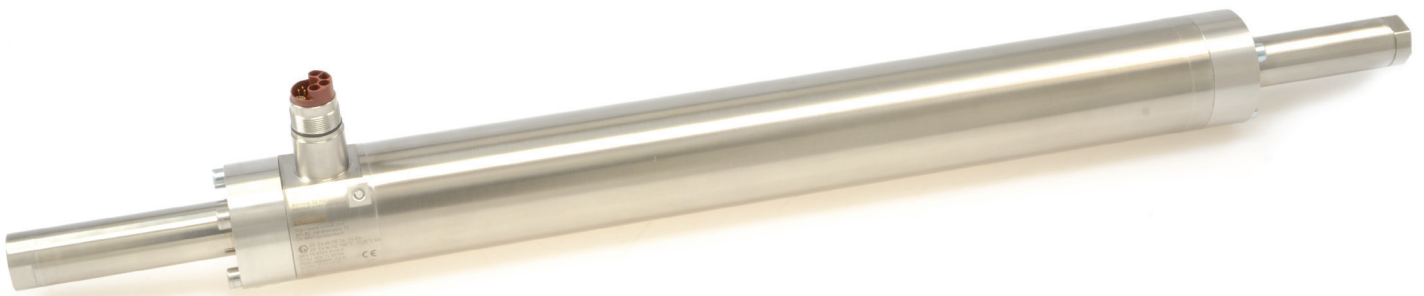

- ✓ For use in an explosive atmosphere consisting of gases, vapors, mist, or dust
- ✓ Welded connections
- ✓ Completely encapsulated
- ✓ Optional integrated water cooling

LINEAR MOTORS P01-48x360F-EX

Technical Data **711**

Motor Specifications

P01-48x360F/80x80-EX-E **714**

P01-48x360F/170x170-EX-E **715**

P01-48x360F/260x260-EX-E **716**

P01-48x360F/380x380-EX-E **717**

P01-48x360F/470x470-EX-E **718**

P01-48x360F/680x680-EX-E **719**

P01-48x360F/860x860-EX-E **720**

Accessories **721**

6

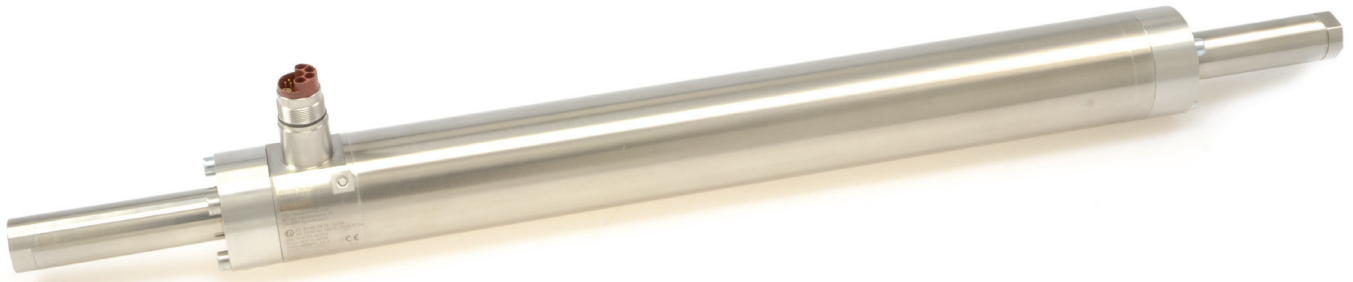

MOTOR FAMILY P01-48X360F-EX

Technical Data				
Stroke				
Max. Stroke	mm	(in)	860	(33.9)
Force				
Max. Force @ 48VDC	N	(lbf)	721	(162)
Max. Force @ 72VDC	N	(lbf)	721	(162)
Max. Cont. Force [Passive cooling / Fan / Fluid]	N	(lbf)	130 / - / 350	(29 / - / 80)
Max. Border Force relative	%		≤ 100	
Force Constant	N/A _{pk}	(lbf/A _{pk})	27.7	(6.24)
Velocity				
Max. Velocity @ 48VDC	m/s	(in/s)	1.6	(62.9)
Max. Velocity @ 72VDC	m/s	(in/s)	2.3	(93.9)
Position Detection				
Position Resolution	mm	(in)	0.007	(0.0003)
Repeatability	mm	(in)	±0.05	(±0.002)
Position Resolution with ES	mm	(in)	0.001	(0.00004)
Repeatability with ES	mm	(in)	±0.01	(±0.0004)
Linearity with ES	mm	(in)	±0.01	(±0.0004)
Electrical Data				
Max. Current @ 48VDC	A _{pk}		25.9	
Max. Current @ 72VDC	A _{pk}		25.9	
Max. Cont. Current [Passive cooling / Fan / Fluid]	A _{pk}		4.6 / - / 13	
Terminal Resistance 25 °C / 120 °C	Ohm		1.4 / 1.9	
Terminal Inductivity	mH		1.6	
Magnetic Period	mm	(in)	60	(2.35)
Thermal Data				
Max. Winding Temperature (Sensor)	°C		90	
Thermal Resistance [Passive cooling / Fan / Fluid]	°K/W		1.3 / - / 0.17	
Thermal Time Constant [Passive cooling / Fan / Fluid]	s		1900 / - / 240	
Mechanical Data				
Stator Diameter	mm	(in)	60	(2.4)
Stator Length	mm	(in)	515	(20)
Stator Mass	g	(lb)	5560	(12.23)
Slider Diameter	mm	(in)	27	(1.1)
Slider Length	mm	(in)	500 - 1400	(20 - 55)
Slider Mass	g	(lb)	2010 - 5910	(4.42 - 13)
IP Code			IP67	

CE 1258 Ex eb IIC T6... T4 Gb

CE 1258 Ex tb IIIC T85°C... T135°C Db

STATOR

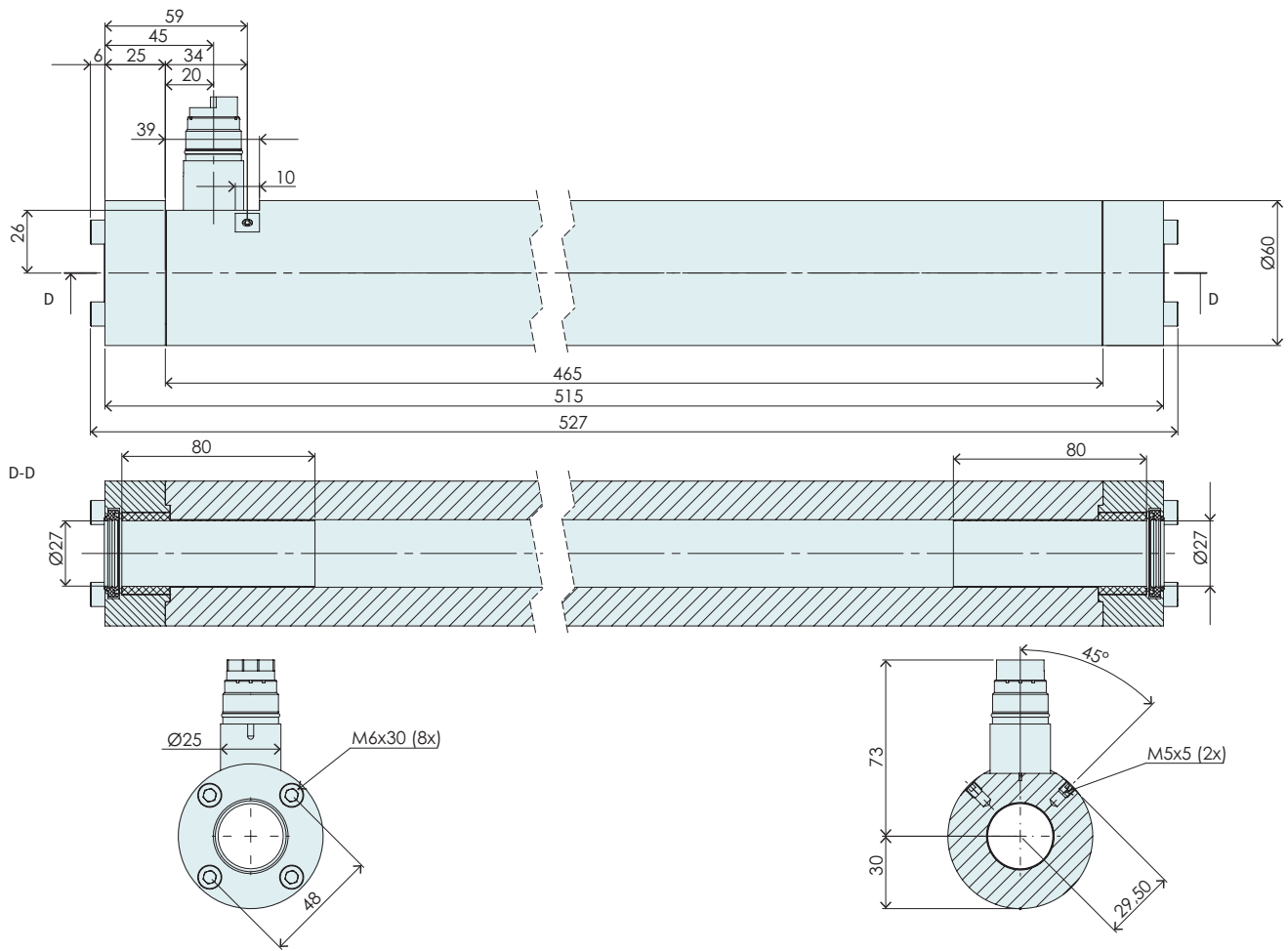

Item	Description	Item-No.
PS01-48x360F-EX-E	Stator EX, IP67	0150-2545
PS01-48x360F-EX-E-FC	Stator EX, IP67, Fluid-Kühlung	0150-1300

CONNECTOR

Motor Connector Wiring	PS01-48x360F-EX-E PS01-48x360F-EX-E-FC	Wire Color Motor Cable
	E6k-Connector	
Ph 1+	A	red
Ph 1-	B	pink
Ph 2+	C	blue
Ph 2-	D	grey
PE	Protective Earth	green-yellow
+5VDC	1	white
GND	2	Inner Shield
Sinus	3	yellow
Cosinus	4	green
Temp.	5	black
n. c.	6	-
Kty 1+	7	orange
Kty 1-	8	brown
Kty 2+	9	purple
Kty 2-	10	beige

E6k-Connector

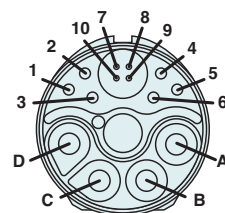

View: Motor connector, plug side

SLIDER

Slider High Clearance

Number of grooves determines the slider type (see chapter 2 / slider) and marks the front end.

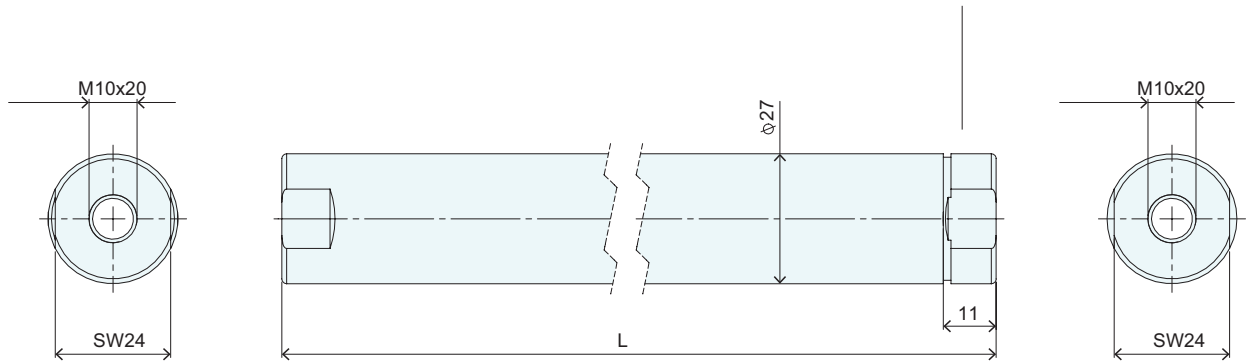

Slider High Clearance			
Item	Description	Max. Stroke [mm]	Item-No.
PL01-27x620/540	Slider 'High Clearance'	80	0150-1470
PL01-27x710/630	Slider 'High Clearance'	170	0150-1471
PL01-27x800/720	Slider 'High Clearance'	260	0150-1472
PL01-27x920/840	Slider 'High Clearance'	380	0150-1447
PL01-27x1010/930	Slider 'High Clearance'	470	0150-1473
PL01-27x1220/1140	Slider 'High Clearance'	680	0150-1587
PL01-27x1400/1320	Slider 'High Clearance'	860	0150-1588

P01-48x360F/80x80-EX-E

Max. Stroke: 80 mm
Peak Force: 721 N

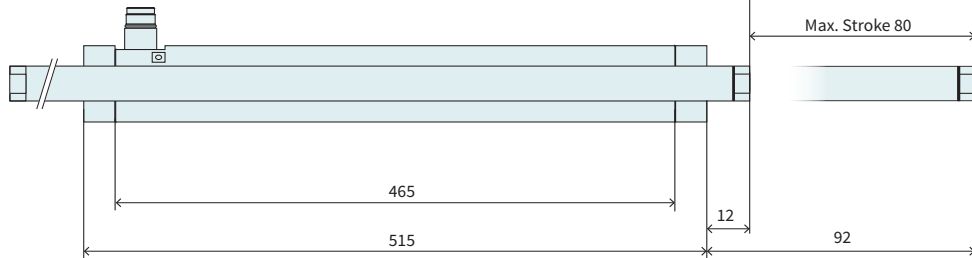
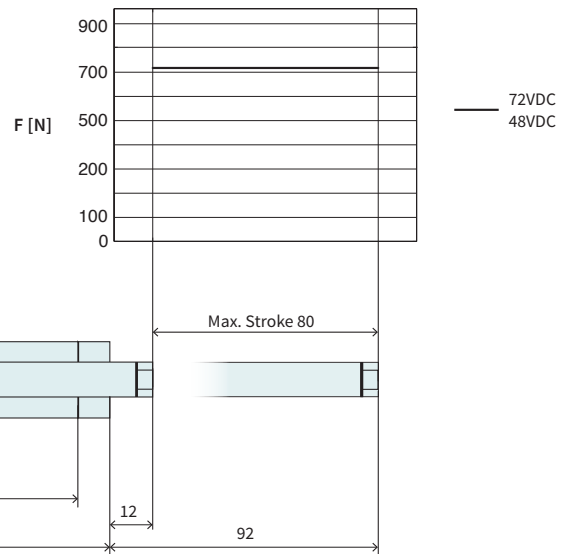

Dimensions in mm

Technical Data P01-48x360F/80x80-EX-E

Stroke			
Max. Stroke	mm (in)	80 (3.14)	
Force			
Max. Force @ 48VDC	N (lbf)	721 (162)	
Max. Force @ 72VDC	N (lbf)	721 (162)	
Max. Cont. Force [Passive cooling / Fan / Fluid]	N (lbf)	130 / - / 350 (29 / - / 80)	
Max. Border Force relative	%	100	
Force Constant	N/A _{pk} (lbf/A _{pk})	27.7 (6.24)	
Velocity			
Max. Velocity @ 48VDC	m/s (in/s)	1.6 (62.9)	
Max. Velocity @ 72VDC	m/s (in/s)	2.3 (93.9)	
Position Detection			
Repeatability	mm (in)	±0.05 (±0.002)	
Linearity	%	± 1.05	
Electrical Data			
Max. Current @ 48VDC	A _{pk}	25.9	
Max. Current @ 72VDC	A _{pk}	25.9	
Max. Cont. Current [Passive cooling / Fan / Fluid]	A _{pk}	4.6 / - / 13	
Thermal Data			
Max. Winding Temperature (Sensor)	°C	90	
Thermal Resistance [Passive cooling / Fan / Fluid]	°K/W	1.3 / - / 0.17	
Thermal Time Constant [Passive cooling / Fan / Fluid]	s	1900 / - / 240	
Mechanical Data			
Slider Length	mm (in)	620 (24)	
Slider Mass	g (lb)	2530 (5.57)	



Item	Description	Item-No.
PS01-48x360F-EX-E	Stator EX, IP67	0150-2545
PS01-48x360F-EX-E-FC	Stator EX, IP67, FC	0150-1300
PB01-48x25-80-P-SSC*	Lager for PS01-48x360-SSC / EX	0150-3413
PL01-27x620/540	Slider 'High Clearance'	0150-1470

* 2 Bearing kits must be ordered separately.

P01-48x360F/170x170-EX-E

Max. Stroke: 170 mm
Peak Force: 721 N

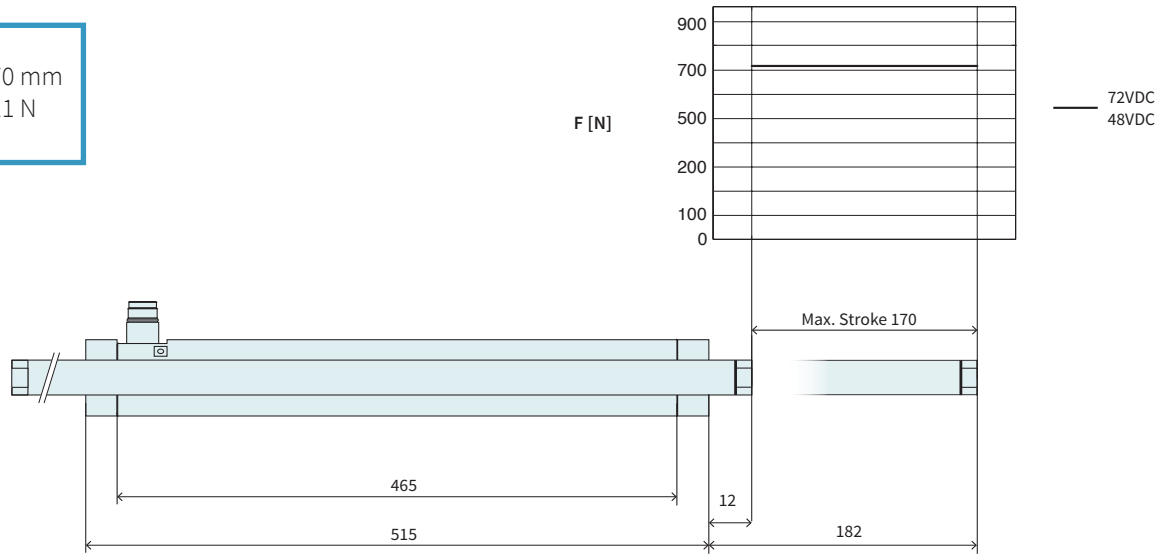

Dimensions in mm

Technical Data P01-48x360F/170x170-EX-E				
Stroke				
Max. Stroke	mm	(in)	170	(6.69)
Force				
Max. Force @ 48VDC	N	(lbf)	721	(162)
Max. Force @ 72VDC	N	(lbf)	721	(162)
Max. Cont. Force [Passive cooling / Fan / Fluid]	N	(lbf)	130 / - / 350	(29 / - / 80)
Max. Border Force relative	%		100	
Force Constant	N/A _{pk}	(lbf/A _{pk})	27.7	(6.24)
Velocity				
Max. Velocity @ 48VDC	m/s	(in/s)	1.6	(62.9)
Max. Velocity @ 72VDC	m/s	(in/s)	2.3	(93.9)
Position Detection				
Repeatability	mm	(in)	±0.05	(±0.002)
Linearity	%		± 0.55	
Electrical Data				
Max. Current @ 48VDC	A _{pk}		25.9	
Max. Current @ 72VDC	A _{pk}		25.9	
Max. Cont. Current [Passive cooling / Fan / Fluid]	A _{pk}		4.6 / - / 13	
Thermal Data				
Max. Winding Temperature (Sensor)	°C		90	
Thermal Resistance [Passive cooling / Fan / Fluid]	°K/W		1.3 / - / 0.17	
Thermal Time Constant [Passive cooling / Fan / Fluid]	s		1900 / - / 240	
Mechanical Data				
Slider Length	mm	(in)	710	(28)
Slider Mass	g	(lb)	2920	(6.42)



Item	Description	Item-No.
PS01-48x360F-EX-E	Stator EX, IP67	0150-2545
PS01-48x360F-EX-E-FC	Stator EX, IP67, FC	0150-1300
PB01-48x25-80-P-SSC*	Lager for PS01-48x360-SSC / EX	0150-3413
PL01-27x710/630	Slider 'High Clearance'	0150-1471

* 2 Bearing kits must be ordered separately.

P01-48x360F/260x260-EX-E

Max. Stroke: 260 mm
Peak Force: 721 N

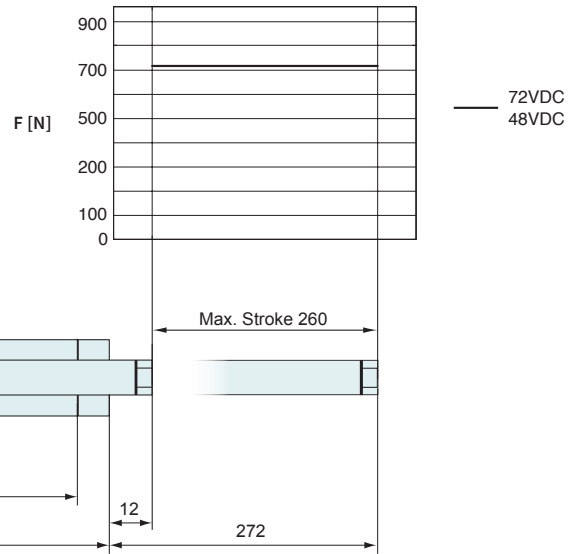

Dimensions in mm

Technical Data P01-48x360F/260x260-EX-E			
Stroke			
Max. Stroke	mm (in)	260	(10.19)
Force			
Max. Force @ 48VDC	N (lbf)	721	(162)
Max. Force @ 72VDC	N (lbf)	721	(162)
Max. Cont. Force [Passive cooling / Fan / Fluid]	N (lbf)	130 / - / 350	(29 / - / 80)
Max. Border Force relative	%	100	
Force Constant	N/A _{pk} (lbf/A _{pk})	27.7	(6.24)
Velocity			
Max. Velocity @ 48VDC	m/s (in/s)	1.6	(62.9)
Max. Velocity @ 72VDC	m/s (in/s)	2.3	(93.9)
Position Detection			
Repeatability	mm (in)	±0.05	(±0.002)
Linearity	%	± 0.4	
Electrical Data			
Max. Current @ 48VDC	A _{pk}	25.9	
Max. Current @ 72VDC	A _{pk}	25.9	
Max. Cont. Current [Passive cooling / Fan / Fluid]	A _{pk}	4.6 / - / 13	
Thermal Data			
Max. Winding Temperature (Sensor)	°C	90	
Thermal Resistance [Passive cooling / Fan / Fluid]	°K/W	1.3 / - / 0.17	
Thermal Time Constant [Passive cooling / Fan / Fluid]	s	1900 / - / 240	
Mechanical Data			
Slider Length	mm (in)	800	(31)
Slider Mass	g (lb)	3310	(7.28)



Item	Description	Item-No.
PS01-48x360F-EX-E	Stator EX, IP67	0150-2545
PS01-48x360F-EX-E-FC	Stator EX, IP67, FC	0150-1300
PB01-48x25-80-P-SSC*	Lager for PS01-48x360-SSC / EX	0150-3413
PL01-27x800/720	Slider 'High Clearance'	0150-1472

* 2 Bearing kits must be ordered separately.

P01-48x360F/380x380-EX-E

Max. Stroke: 380 mm
Peak Force: 721 N

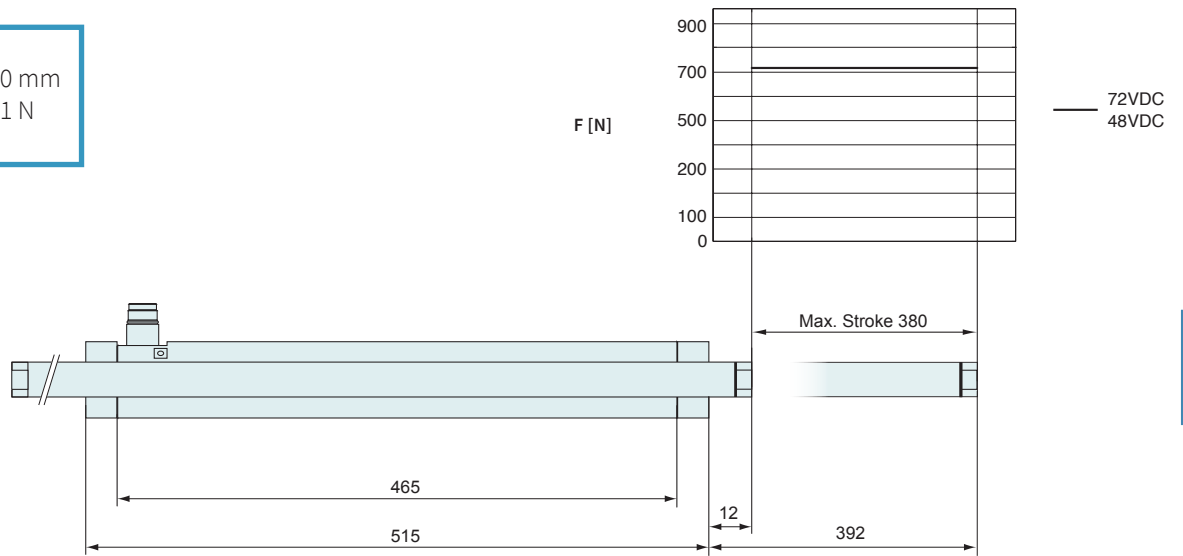

Dimensions in mm

Technical Data P01-48x360F/380x380-EX-E				
Stroke				
Max. Stroke	mm	(in)	380	(14.99)
Force				
Max. Force @ 48VDC	N	(lbf)	721	(162)
Max. Force @ 72VDC	N	(lbf)	721	(162)
Max. Cont. Force [Passive cooling / Fan / Fluid]	N	(lbf)	130 / - / 350	(29 / - / 80)
Max. Border Force relative	%		100	
Force Constant	N/A _{pk}	(lbf/A _{pk})	27.7	(6.24)
Velocity				
Max. Velocity @ 48VDC	m/s	(in/s)	1.6	(62.9)
Max. Velocity @ 72VDC	m/s	(in/s)	2.3	(93.9)
Position Detection				
Repeatability	mm	(in)	±0.05	(±0.002)
Linearity	%		± 0.3	
Electrical Data				
Max. Current @ 48VDC	A _{pk}		25.9	
Max. Current @ 72VDC	A _{pk}		25.9	
Max. Cont. Current [Passive cooling / Fan / Fluid]	A _{pk}		4.6 / - / 13	
Thermal Data				
Max. Winding Temperature (Sensor)	°C		90	
Thermal Resistance [Passive cooling / Fan / Fluid]	°K/W		1.3 / - / 0.17	
Thermal Time Constant [Passive cooling / Fan / Fluid]	s		1900 / - / 240	
Mechanical Data				
Slider Length	mm	(in)	920	(36)
Slider Mass	g	(lb)	3830	(8.43)

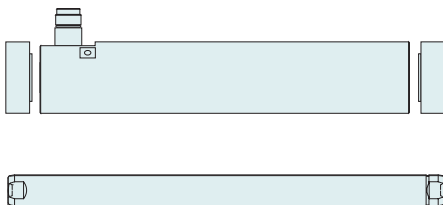

Item	Description	Item-No.
PS01-48x360F-EX-E	Stator EX, IP67	0150-2545
PS01-48x360F-EX-E-FC	Stator EX, IP67, FC	0150-1300
PB01-48x25-80-P-SSC*	Lager for PS01-48x360-SSC / EX	0150-3413
PL01-27x920/840	Slider 'High Clearance'	0150-1447

* 2 Bearing kits must be ordered separately.

P01-48x360F/470x470-EX-E

Max. Stroke: 470 mm
Peak Force: 721 N

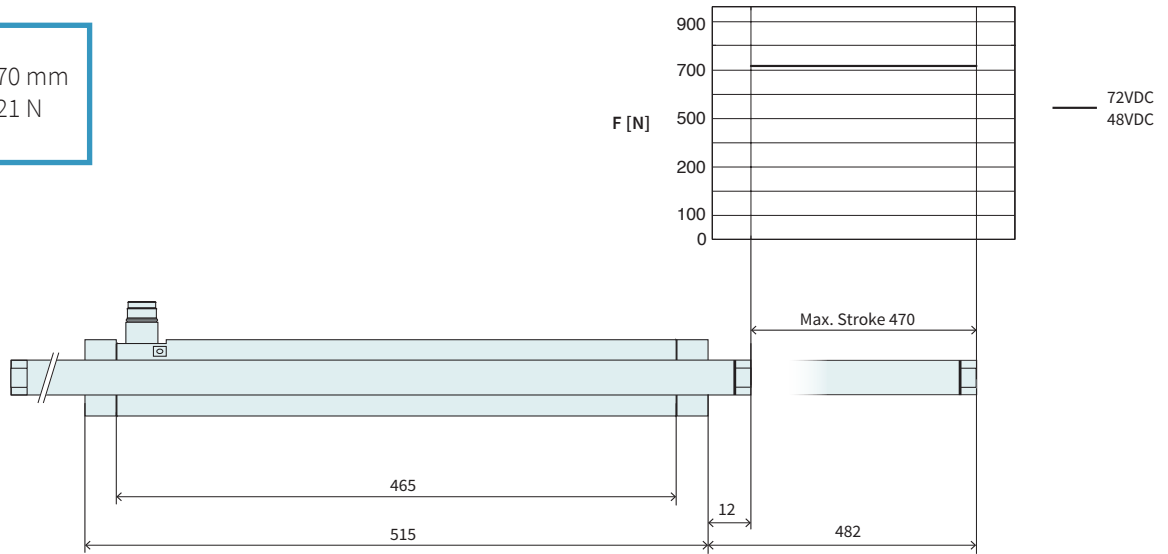

Dimensions in mm

Technical Data P01-48x360F/470x470-EX-E

Stroke			
Max. Stroke	mm (in)	470	(18.49)
Force			
Max. Force @ 48VDC	N (lbf)	721	(162)
Max. Force @ 72VDC	N (lbf)	721	(162)
Max. Cont. Force [Passive cooling / Fan / Fluid]	N (lbf)	130 / - / 350	(29 / - / 80)
Max. Border Force relative	%	100	
Force Constant	N/A _{pk} (lbf/A _{pk})	27.7	(6.24)
Velocity			
Max. Velocity @ 48VDC	m/s (in/s)	1.6	(62.9)
Max. Velocity @ 72VDC	m/s (in/s)	2.3	(93.9)
Position Detection			
Repeatability	mm (in)	±0.05	(±0.002)
Linearity	%	± 0.25	
Electrical Data			
Max. Current @ 48VDC	A _{pk}	25.9	
Max. Current @ 72VDC	A _{pk}	25.9	
Max. Cont. Current [Passive cooling / Fan / Fluid]	A _{pk}	4.6 / - / 13	
Thermal Data			
Max. Winding Temperature (Sensor)	°C	90	
Thermal Resistance [Passive cooling / Fan / Fluid]	°K/W	1.3 / - / 0.17	
Thermal Time Constant [Passive cooling / Fan / Fluid]	s	1900 / - / 240	
Mechanical Data			
Slider Length	mm (in)	1010	(40)
Slider Mass	g (lb)	4220	(9.28)

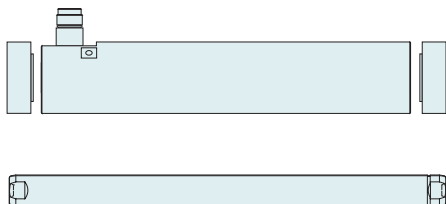

Item	Description	Item-No.
PS01-48x360F-EX-E	Stator EX, IP67	0150-2545
PS01-48x360F-EX-E-FC	Stator EX, IP67, FC	0150-1300
PB01-48x25-80-P-SSC*	Lager for PS01-48x360-SSC / EX	0150-3413
PL01-27x1010/930	Slider 'High Clearance'	0150-1473

* 2 Bearing kits must be ordered separately.

P01-48x360F/680x680-EX-E

Max. Stroke: 680 mm
Peak Force: 721 N

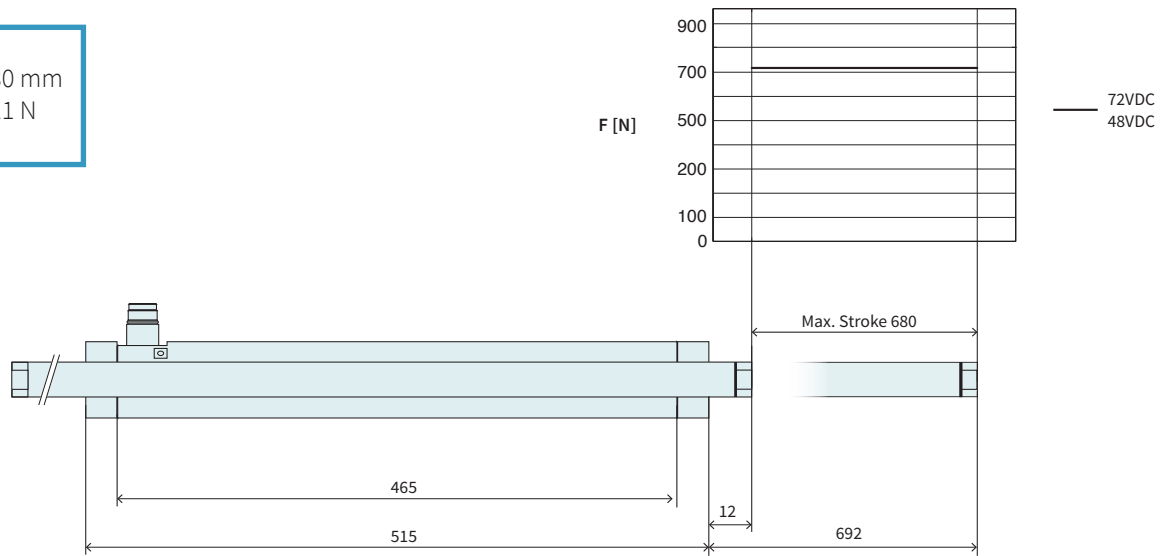

Dimensions in mm

Technical Data P01-48x360F/680x680-EX-E				
Stroke				
Max. Stroke	mm	(in)	680	(26.8)
Force				
Max. Force @ 48VDC	N	(lbf)	721	(162)
Max. Force @ 72VDC	N	(lbf)	721	(162)
Max. Cont. Force [Passive cooling / Fan / Fluid]	N	(lbf)	130 / - / 350	(29 / - / 80)
Max. Border Force relative	%		100	
Force Constant	N/A _{pk}	(lbf/A _{pk})	27.7	(6.24)
Velocity				
Max. Velocity @ 48VDC	m/s	(in/s)	1.6	(62.9)
Max. Velocity @ 72VDC	m/s	(in/s)	2.3	(93.9)
Position Detection				
Repeatability	mm	(in)	±0.05	(±0.002)
Linearity	%		± 0.2	
Electrical Data				
Max. Current @ 48VDC	A _{pk}		25.9	
Max. Current @ 72VDC	A _{pk}		25.9	
Max. Cont. Current [Passive cooling / Fan / Fluid]	A _{pk}		4.6 / - / 13	
Thermal Data				
Max. Winding Temperature (Sensor)	°C		90	
Thermal Resistance [Passive cooling / Fan / Fluid]	°K/W		1.3 / - / 0.17	
Thermal Time Constant [Passive cooling / Fan / Fluid]	s		1900 / - / 240	
Mechanical Data				
Slider Length	mm	(in)	1220	(48)
Slider Mass	g	(lb)	5130	(11.29)

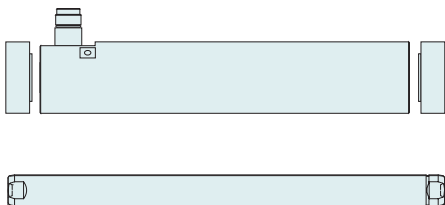

Item	Description	Item-No.
PS01-48x360F-EX-E	Stator EX, IP67	0150-2545
PS01-48x360F-EX-E-FC	Stator EX, IP67, FC	0150-1300
PB01-48x25-80-P-SSC*	Lager for PS01-48x360-SSC / EX	0150-3413
PL01-27x1220/1140	Slider 'High Clearance'	0150-1587

* 2 Bearing kits must be ordered separately.

P01-48x360F/860x860-EX-E

Max. Stroke: 860 mm
Peak Force: 721 N

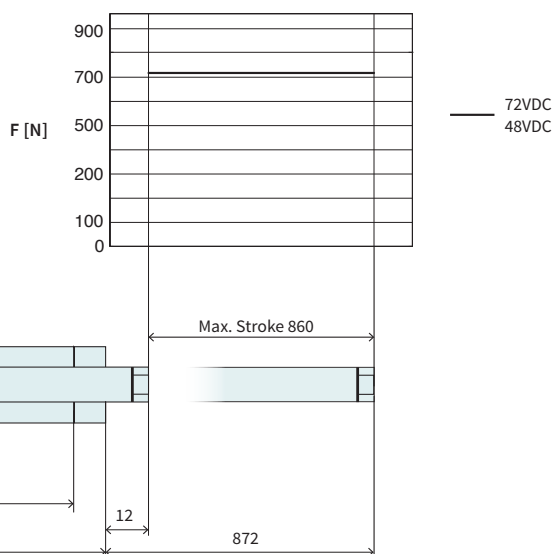

Dimensions in mm

Technical Data P01-48x360F/860x860-EX-E

Stroke			
Max. Stroke	mm (in)	860	(33.89)
Force			
Max. Force @ 48VDC	N (lbf)	721	(162)
Max. Force @ 72VDC	N (lbf)	721	(162)
Max. Cont. Force [Passive cooling / Fan / Fluid]	N (lbf)	130 / - / 350	(29 / - / 80)
Max. Border Force relative	%	100	
Force Constant	N/A _{pk} (lbf/A _{pk})	27.7	(6.24)
Velocity			
Max. Velocity @ 48VDC	m/s (in/s)	1.6	(62.9)
Max. Velocity @ 72VDC	m/s (in/s)	2.3	(93.9)
Position Detection			
Repeatability	mm (in)	±0.05	(±0.002)
Linearity	%	± 0.2	
Electrical Data			
Max. Current @ 48VDC	A _{pk}	25.9	
Max. Current @ 72VDC	A _{pk}	25.9	
Max. Cont. Current [Passive cooling / Fan / Fluid]	A _{pk}	4.6 / - / 13	
Thermal Data			
Max. Winding Temperature (Sensor)	°C	90	
Thermal Resistance [Passive cooling / Fan / Fluid]	°K/W	1.3 / - / 0.17	
Thermal Time Constant [Passive cooling / Fan / Fluid]	s	1900 / - / 240	
Mechanical Data			
Slider Length	mm (in)	1400	(55)
Slider Mass	g (lb)	5910	(13)



Item	Description	Item-No.
PS01-48x360F-EX-E	Stator EX, IP67	0150-2545
PS01-48x360F-EX-E-FC	Stator EX, IP67, FC	0150-1300
PB01-48x25-80-P-SSC*	Lager for PS01-48x360-SSC / EX	0150-3413
PL01-27x1400/1320	Slider 'High Clearance'	0150-1588

* 2 Bearing kits must be ordered separately.

Motor Cable

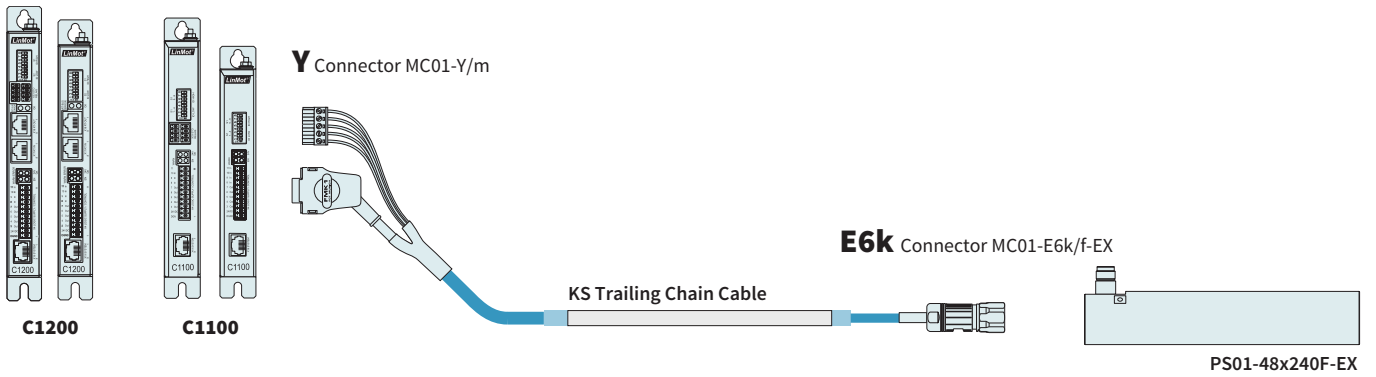

ORDERING INFORMATION

TRAILING CHAIN CABLE		
Item	Description	Item-No.
KS10-EX-Y-Fe/E6k-	Trailing Chain Cable KS10-EX-Y-Fe/E6k-, Custom length	0150-3642

CONNECTOR & CABLE (INDIVIDUAL)		
Item	Description	Item-No.
MC01-Y-Fe/m	Motor Connector Y-Fe/m	0150-3289
MC01-E6k/f-EX	Connector with hexagonal union nut	0150-3538
KS10-05/05/04-EX	Motor cable for EX applications per m	0150-9010

SLIDER MOUNTING



Item	Description	Item-No.
PLF01-28-SS	Fixed Bearing Set for 27/28 mm sliders, stainless steel	0150-3297
PLL01-27	Floating Bearing for 27 mm sliders	0150-3294

FIND MORE PRODUCT DETAILS IN THE CHAPTER „ACCESSORIES“.

BEARING KIT

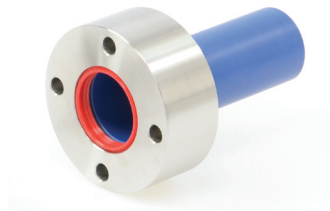

Item	Description	Item-No.
PB01-48x25-80-P-SSC	Lager for PS01-48x360-SSC (Edelstahl)	0150-3413

FIND MORE PRODUCT DETAILS IN THE CHAPTER „ACCESSORIES“.